

Каталог решений по хранению инструмента

По вопросам продаж и поддержки обращайтесь: bch@nt-rt.ru

www.bahco.nt-rt.ru

Архангельск (8182)63-90-72,
Астана+7(7172)727-132,
Белгород(4722)40-23-64,
Брянск(4832)59-03-52,
Владивосток(423)249-28-31,
Волгоград(844)278-03-48,
Вологда(8172)26-41-59,
Воронеж(473)204-51-73,
Екатеринбург(343)384-55-89,
Иваново(4932)77-34-06,
Ижевск(3412)26-03-58,
Казань(843)206-01-48,
Калининград(4012)72-03-81,
Калуга(4842)92-23-67,
Кемерово(3842)65-04-62,
Киров(8332)68-02-04,

Краснодар(861)203-40-90,
Красноярск(391)204-63-61,
Курск(4712)77-13-04,
Липецк(4742)52-20-81,
Магнитогорск(3519)55-03-13,
Москва(495)268-04-70,
Мурманск(8152)59-64-93,
НабережныеЧелны(8552)20-53-41,
НижнийНовгород(831)429-08-12,
Новокузнецк(3843)20-46-81,
Новосибирск(383)227-86-73,
Орел(4862)44-53-42,
Оренбург(3532)37-68-04,
Пенза(8412)22-31-16,
Пермь(342)205-81-47,
Ростов-на-Дону(863)308-18-15,

Рязань(4912)46-61-64,
Самара(846)206-03-16,
Санкт-Петербург(812)309-46-40,
Саратов(845)249-38-78,
Смоленск(4812)29-41-54,
Сочи(862)225-72-31,
Ставрополь(8652)20-65-13,
Тверь(4822)63-31-35,
Томск(3822)98-41-53,
Тула(4872)74-02-29,
Тюмень(3452)66-21-18,
Ульяновск(8422)24-23-59,
Уфа(347)229-48-12,
Челябинск(351)202-03-61,
Череповец(8202)49-02-64,
Ярославль(4852)69-52-93,



**MOST FLEXIBLE
SOLUTION**



▶ A RANGE OF TOOLS AS INDIVIDUAL AS YOUR

Comprehensive range with more than 15,000 products

More than 500 ergonomic hand tools

Numerous proven standard ranges

Development of customised workshop trolleys and ranges

For the first time, Bahco, the innovation driver of the tool sector, is offering a free software solution which allows customers to optimally design and configure their workshop trolley, foam inserts and tools to their individual requirements.

The software allows you to configure everything from the individual composition of your tool selection or the customisation, colour scheme and marking of inserts and workshop trolleys. Apart from the economic benefits of reducing the assortment of tools to the needs of your individual job,

Bahco Tool Solutions offers additional advantages not only for technically sensitive applications. The personalisation of your tools is based on your specific allocation plan through laser-etched labelling that will provide long-term logistical and security benefits which you can count on. Bahco Tool Solutions: All-round efficiency.

Contents Page

Configuration software BETMS 4 – 5

Storage systems 6 – 7

Personalised tool assortments 8 – 9

Tool control and security 10 – 11

JOBS



► CONFIGURATION SOFTWARE Bahco Ergo Tool M

Designing your workshop trolley

- Frames in various colours and sizes
- Free combination of drawer and frame colours
- Variety of drawer capacities
- Selection of various work surfaces (stainless steel, wooden or rubberised surface)
- Additional accessories such as folding work surface, can holder etc.

Putting together your individual tooling selection

- Choice of tools from the comprehensive Bahco range
- Inclusion of existing tools possible
- Individual layout of tools in each draw

Bahco's vision was nothing less than the total customisation of the workshop trolley and tool assortment to suit the requirements of the user.

In order to realise this vision, Bahco has developed BETMS: a software solution that enables the user to create their own optimal, personalised solution from Bahco's extensive range of tools, workshop trolleys and other storage solutions, as well as the tool assortment.

Benefits

- Your assortment only contains the tools you actually use and makes it easy to quickly find the right tool
- Cost savings by eliminating unused tools or particular sizes included in standard assortments
- Laser engraving brings security benefits and helps to prevent theft
- Variety of trolley colour schemes can support your corporate design or individual company image

Personalising your tools

- Laser marking
- Development and manufacturing of essential tools

Personalised design of your tool tray inserts

- Sizes
- Cut-outs
- Layout
- Colours



ERGO TOOL MANAGEMENT SYSTEM

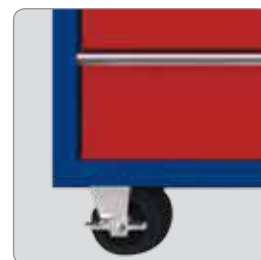

Management System BETMS

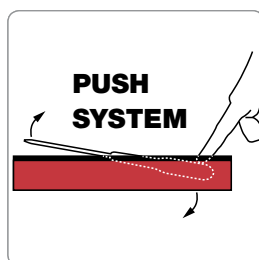

▶ STORAGE SYSTEMS Workshop trolleys



The flexible workshop trolley range

The extensive range of high quality Bahco workshop trolleys is optimally directed towards the daily requirements of the professional user. Numerous workshop trolleys in different colours and with various combinations of drawers are available as standard stock items.

- Choice of work surfaces: stainless steel, rubber, solid wood
- Lock & Go locking system prevents the accidental opening of the drawers if the trolley is moved
- 2 fixed castors and 2 swivelling castors with brakes
- Fully openable drawers with ball-bearing slides
- Double wall frame. Drawers and slides will still work perfectly even if the frame gets damaged
- Load-bearing capacity: 900 – 1 000 kg
- Comprehensive range of accessories
- Drawer capacity: 45 kg



1475K Series
Standard colours



1470K Series
Standard colours

▶ TOOL CASES AND TOOLBOXES



Tool assortments for mobile applications

With a Bahco tool case or toolbox, you always have the most important tools to hand in every job.

Choose from either our proven standard assortment or ask us to help you put together one tailored to suit your requirements.

You will also benefit from our customised foam inserts:

You will be able to see at a glance which tool belongs where and whether one is missing – an important advantage when you are out on a job where you are unable to pick up a replacement.

Rigid cases:

- Stable tool case made from polypropylene
- With telescopic handle and wheels
- Resistant to temperature fluctuations, dirt and water
- Pressure equalisation valve
- Lockable and stackable with identification label



Metal toolboxes:

- Aluminium chequer plate case for safe grip and lid reinforcement
- Fully openable drawers
- Handles on sides and lid for safe transport
- Tool holders in lid for additional storage space



▶ PERSONALISED TOOL ASSORTMENTS Tools

High quality hand tools

With an extensive range of over 15,000 products, 11 European production sites and over 150 years' experience in the development and production of hand tools, Bahco is your ideal partner for creating personalised tool solutions.

- Comprehensive range with more than 15.000 products
- More than 500 ergonomic hand tools
- More than 150 years' experience in the manufacture of hand tools



Efficiency and safety through ergonomic hand tools

Ergonomic hand tools provide the user with a high degree of control, comfort and precision.

All Bahco tools which carry the ERGO™ logo have been developed, tested and manufactured in accordance with our ERGO™ scientific development programme.



▶ TOOL TRAY INSERTS

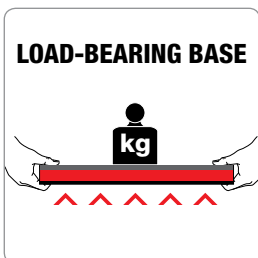
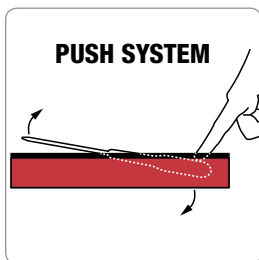

Configuring your individual tool inserts

- Flexible layout of tools in the foam
- Push System: simplified tool withdrawal through recesses
- Choice of foam colours
- Every tool has its own place:
bi-coloured foams enable rapid identification of a missing tool
- Customer-specific solutions possible

Selection of a proven standard assortment

- Choose from our proven standard range of products
- Available for both workshop trolleys and mobile applications



▶ TOOL CONTROL AND SECURITY Personalisation



[LOGO] RP04 - 0838/005

Labelling of tools

Effective use and maximum reliability in many technical areas is absolutely essential today. Take aviation for example – with ever shorter ground times, security checks and maintenance work have to be precisely organised to ensure a smooth and error-free service.

So that every technician always has his equipment ready for use, we offer the option of personalising tools and inserts with laser etching. This also helps to prevent mix-ups or theft of equipment parts.

- Logo marking
- Coding with any combination of numbers and letters
- Anti-theft protection through ownership control
- Prevents mix-ups on large construction sites
- Cost savings by minimising tool shortages





Tool control

- Checking the completeness of tools in workshop trolleys in critical applications e.g. aviation, mechanical engineering, laboratory equipment technology, food industry
- Storage of any amount of information for individual allocation plans (person, trolley, field of work)





MOST FLEXIBLE SOLUTION



www.bahco.com



A registered trademark of SNA Europe Group

NEW GENERATION OF SOFT BAGS



Specifically developed to make your job easier

► BUILDERS OPEN BAG

4750FB1-19A

Velcro straps for long tools:
Spirit levels, tubes and similar longer material can be stored using those straps with the quick velcro system positioned in both upper side of the bag

Soft grip handle:
Made of rubberized material. Provides a user friendly grip and isolates from touching any cold material

HARD BOTTOM
100% waterproof



Measuring tape, card holder & phone pocket on one side

Hand saw special pocket:
With a zip and velcro strap for a quick storage, avoids any accident and / or lost during transport

Code: 4750FB1-19A

3100TB

600 x 400 x 400 mm

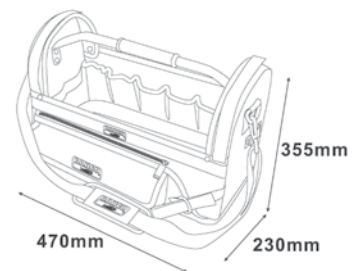

BUILDERS OPEN & CLOSE CASE ◀

4750FB1-19B



Velcro straps for rolling the cover: keeps the bag open when necessary but, at the same time, the handsaw and other pockets can be still used

Screwdriver section: with elastics for keeping those tools always at hand

Soft grip handle made of rubberized material provides a user friendly grip and isolates from touching any cold material



Measuring tape, card holder & phone pocket on one side

Hand Saw special pocket: with a zip and velcro strap for a quick storage, avoids any accident and / or lost during transport

Internal detachable tool panel with velcro system for quickly removing and bringing the needed tools. Elastics and pockets included

Code: 4750FB1-19B

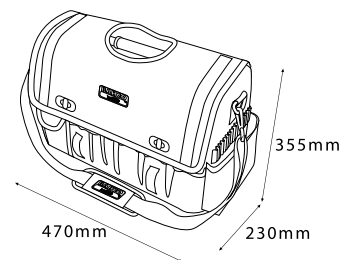

Softgrip handle access trough the cover

Velcro straps for long tools

Spirit level elastics
Holders on back side

Hard bottom: 100% waterproof



Specifically developed to make your job easier

▶ OPEN BAG WITH WHEELS

4750FB2W-24A



Multiple screwdrivers
Internal pocket section

Handsaw internal
zipped pocket

Under lid net zipped
pocket for documents

10" Tablet
size specific pocket

Elastic & velcro quick
adjustable straps
for long tools such as
spirit levels, tubes...

Side horizontal handles:
for easier pulling the bag
when stored in confine
places, pic ups, etc

Side big pouches:
Left one zipped detachable
Right fixed one includes
a plastic box for small
consumables: screws,
nuts, washers, terminals

HARD BOTTOM

100% waterproof



Telescopic handle:
960 mm max

Externally positioned pu
80 x 25 mm wheels:
For better stability and
Silent when rolling

Card holder

Code: 4750FB2W-24A

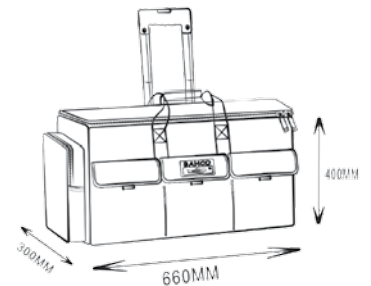

“THE ORIGINAL” CLOSE BAG ◀

4750FB2-19A

4750FB2-24A



Double heavy duty zips

Multiple internal and external pockets

4 practical pockets on one side

Handsaw internal holder (tip protector & handle velcro holder)

Quick adjustable straps for long tools such as spirit levels, tubes...

Measuring tape, card holder & phone pocket on one side



HARD BOTTOM

100% waterproof



Code: 4750FB2-19A

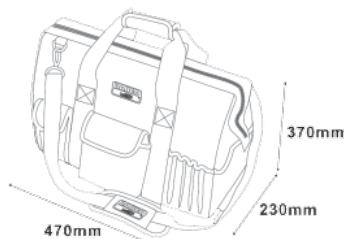

Code: 4750FB2-24A

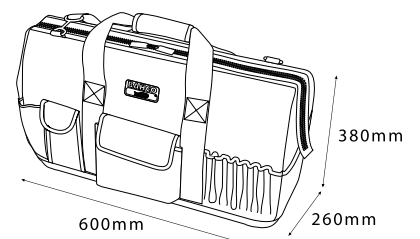

Specifically developed to make your job easier

▶ LAPTOP TOOLS BAG

4750FB4-18



Divers height pockets and sections in each compartment allows a better tool distribution and to bring only one to the work place for avoiding carrying a heavy bag

Document pocket in each side detachable compartment

Central big padded compartment for laptop and similar delicate material and two detachable side sections

Measuring tape, card holder & phone pocket on one side



Side detachable compartment: each one has its own design for better covering the needs of each user



HARD BOTTOM
100% waterproof



Code: 4750FB4-18

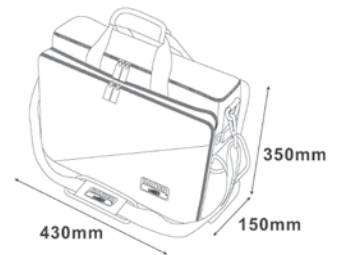

ELECTRICIAN BAG ◀

4750FB3-12



Multiple screwdrivers elastic section
In front and back side

Divers height pockets replicated in both sides

Hd reinforced handle provides stability and strength the bag

Central big compartment for bigger tools or material

Measuring tape, card holder & phone pocket on one side

HARD BOTTOM
100% waterproof



Big bottom pocket including a plastic box for small consumables: screws, nuts, washers, terminals

▶ BAHCO FOLDERS



- Measuring tape holder
- Rubber soft handle
- **Multiple elastics** for tool distribution in the bottom and upper side
- **Card holder** on front and labelling holder on the side for quick identification

Code: 4750FB3-12

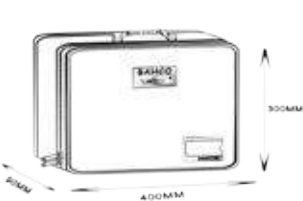

Specifically developed to make your job easier

▶ PLASTIC TOOL BOXES



4750PTB60

600 x 305 x 295 mm

Capacity 37 liters



Made of virgin polypropylene (pp)
What makes the box really
**Heavy duty even if used
under extreme conditions**

The aluminum handle facilitates transportation. If you lift the handle, the bottom part is blocked, preventing the box from opening accidentally

Internal tray is very helpful for taking only the needed tools into the area or keeping it tidy

Locking system:

Even if the latches are open, when the alu handle is in vertical position blocks the bottom part of the box avoiding the box to open accidentally

4750PTB50

500 x 295 x 270 mm

Capacity 27 liters



Sturdy and big load capacity:

The design of the box, with Nerves and specific shapes on The corners make it more sturdy increasing the load capacity

1496MB2

530 x 290 x 290 mm

1496MB3

690 x 360 x 310 mm

1496MB4

910 x 530 x 530 mm

1496MB5

830 x 440 x 340 mm



MASON BOX

- HD constructions with weld points in key areas for making the box robust
- Internal protection using a 3.2mm thick plywood with anti-humidity treatment
- Combination of 0.8mm and 1.0mm thickness steel on the stressed areas for avoiding any deformation
- All boxes are including a tool tray which helps the user to carry the needed tools
- Orange powder coating with a texture finishing that is more resistant to the toughest working environments

4750PTBW47

470 x 290 x 630 mm

Capacity 60 liters



BAHCO



www.bahco.com

SNA Europe B&C-1272-INT

Bahco is a registered trademark of SNA Europe Group



A registered trademark of SNA Europe Group



WORKBENCHES AND CABINETS



▶ CABINETS

1495SC15

1500 x 170 x 900 mm

1495SC18

1800 x 170 x 900 mm

1495CD60

605 x 250 x 900 mm



Compact structure
The steel frame and grid make it very robust and capable to load it heavily

Rolling system
Can be easily rolled down using the two handles available

Locking system
The cabinet can be easily closed and even secured with a key

Perforated panel on sides
User can store any specific tools/ thing. 100% opening slides provide full access



▶ BUILD UP YOUR OWN WORKBENCH!

1495WB15TS

1495WB18TS

1495WB15TD

1495WB18TD

1495WB15TW

1495WB18TW

1500 x 750 x 1030 mm

1800 x 750 x 1030 mm

Choose from the extensive Bahco standard 1470K 5

- ▶ **Wooden top:**
With 40mm thickness and varnished finished for long lasting, absorbs very well impacts and lubricants
- ▶ **Steel top:**
With 2mm thickness, it is strategically bended for making it very strong and heavy duty



▶ ACCESSORIES

1495WB-AC1

500 x 500 x 105 mm

1495WB-AC2

570 x 528 x 160 mm

1495WB15-AC1

1500 x 504 x 30 mm

1495WB18-AC1

1800 x 504 x 30 mm



Includes metallic dividers
Can be assembled in any of the sizes

Bottom tray
Provides storing surface for boxes, cases and similar bulky things



TOOL PANELS

1495TP06

600 x 25 x 500 mm

1495TP12

1200 x 25 x 800 mm

1495TP15

1500 x 25 x 800 mm

1495TP18

1800 x 25 x 800 mm

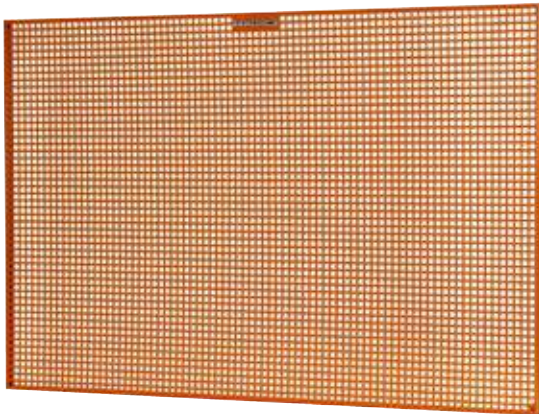

Sturdy frame:

The panel has a frame which is bended in the edges in order to be able to stand and be mounted in walls. Stands big loads without having any deformation

Accessories:

1495CS-AC1 / 1495CD-AC1 includes 35 and 24 different hooks which is a good base for the majority of the users. Available for all cabinets and panels

1495TP-AC1 accessory is used for attaching the tool panels to workbenches with wooden or MDF tops

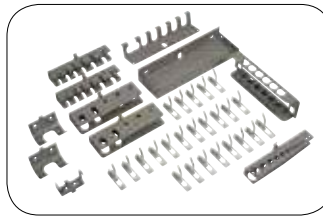

1495CS-AC1

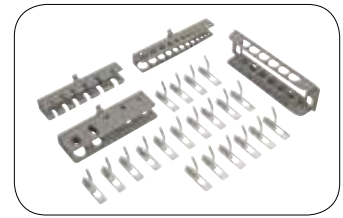

1495CD-AC1



Series trolley solutions by selecting

1 Dimensions: 1500 mm, 1800 mm

3 Colours: orange, red, blue and black

2 Number of drawers: 5, 6, 7, 8

4 Tops: wooden, MDF, steel

MDF top:

With 40mm thickness, it is very consistent in strength and size

Structure:

The U shape provides robustness
The H shape welded feet brings strength to the workbench
Assembly is easy and quick
The feet has a flat shape for higher stability
Includes anti slippery vulcanized rubber for safety

Load capacity: 1,5T



1470K Series features and benefits:

Heavy duty construction with strong reinforcement in key areas
Total static load capacity: 600 kg

Long ball bearing slides
100% opening drawers
Load capacity per drawer: 30 kg

Double wall frame
Drawers and slides work even if the frame gets damaged

		1500 MM				1800 MM			
		Orange	Red	Black	Blue	Orange	Red	Black	Blue
MDF	5	1495K5WB15TD	1495K5REDWB15TD	1495K5BKWB15TD	1495K5BLWB15TD	1495K5WB18TD	1495K5REDWB18TD	1495K5BKWB18TD	1495K5BLWB18TD
	6	1495K6WB15TD	1495K6REDWB15TD	1495K6BKWB15TD	1495K6BLWB15TD	1495K6WB18TD	1495K6REDWB18TD	1495K6BKWB18TD	1495K6BLWB18TD
	7	1495K7WB15TD	1495K7REDWB15TD	1495K7BKWB15TD	1495K7BLWB15TD	1495K7WB18TD	1495K7REDWB18TD	1495K7BKWB18TD	1495K7BLWB18TD
	8	1495K8WB15TD	1495K8REDWB15TD	1495K8BKWB15TD	1495K8BLWB15TD	1495K8WB18TD	1495K8REDWB18TD	1495K8BKWB18TD	1495K8BLWB18TD
WOODEN	5	1495K5WB15TW	1495K5REDWB15TW	1495K5BKWB15TW	1495K5BLWB15TW	1495K5WB18TW	1495K5REDWB18TW	1495K5BKWB18TW	1495K5BLWB18TW
	6	1495K6WB15TW	1495K6REDWB15TW	1495K6BKWB15TW	1495K6BLWB15TW	1495K6WB18TW	1495K6REDWB18TW	1495K6BKWB18TW	1495K6BLWB18TW
	7	1495K7WB15TW	1495K7REDWB15TW	1495K7BKWB15TW	1495K7BLWB15TW	1495K7WB18TW	1495K7REDWB18TW	1495K7BKWB18TW	1495K7BLWB18TW
	8	1495K8WB15TW	1495K8REDWB15TW	1495K8BKWB15TW	1495K8BLWB15TW	1495K8WB18TW	1495K8REDWB18TW	1495K8BKWB18TW	1495K8BLWB18TW

FOLDABLE WORKBENCH

1495FWB097TS

970 x 500 x 840 mm

Galvanized Top

1495FWB120TS

1200 x 500 x 840 mm

Galvanized Top

1495FWB097TD

970 x 500 x 840 mm

MDF + Galvanized Top

1495FWB120TD

1200 x 500 x 840 mm

MDF + Galvanized Top

Load Capacity:
300 kg

Compact structure:
Scissor system: compact bridges provide strength and stability



Rubber handle

Plastic caps in structure top sides:
Make the top mounting easy and tight for avoiding any movement while working

Plastic caps in structure's feet:
Provide stability and avoids any slippery situation regardless the surface we are working on



TOOL PANEL WITH WHEELS

1495TP10W

1000 x 450 x 1500 mm

Wheels with brake
(2) for avoiding any unexpected movement

Accessories:
1495CS-AC1 / 1495CD-AC1 includes 35 and 24 different hooks which is a good base for the majority of the users



Tray on top just for storing any screw, nut, etc

Handles in both sides for easy moving the trolley and providing more safety

Spacious bottom compartment for storing bulky tools, products, tanks or similar

Load Capacity:
300 kg

CABINET WITH 2 DOORS ON WHEELS

1495CD60W

760 x 250 x 1500 mm

Compact structure
1mm & 2mm sheet metal
The steel frame makes it very robust and capable to load it heavily

Reinforced roll cart brings flexibility for moving around the cabinet as well as enlarging the storage capacity thanks to the two trays

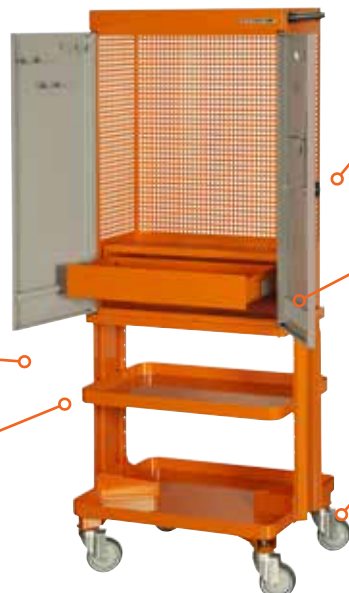

Locking system
The cabinet can be easily closed and even secured with a key

The doors are opened 180° for full access

Wheels with brake
(2) for avoiding any unexpected movement

Accessories:
1495CS-AC1 / 1495CD-AC1 includes 35 and 24 different hooks which is a good base for the majority of the users



Pouches and Belts

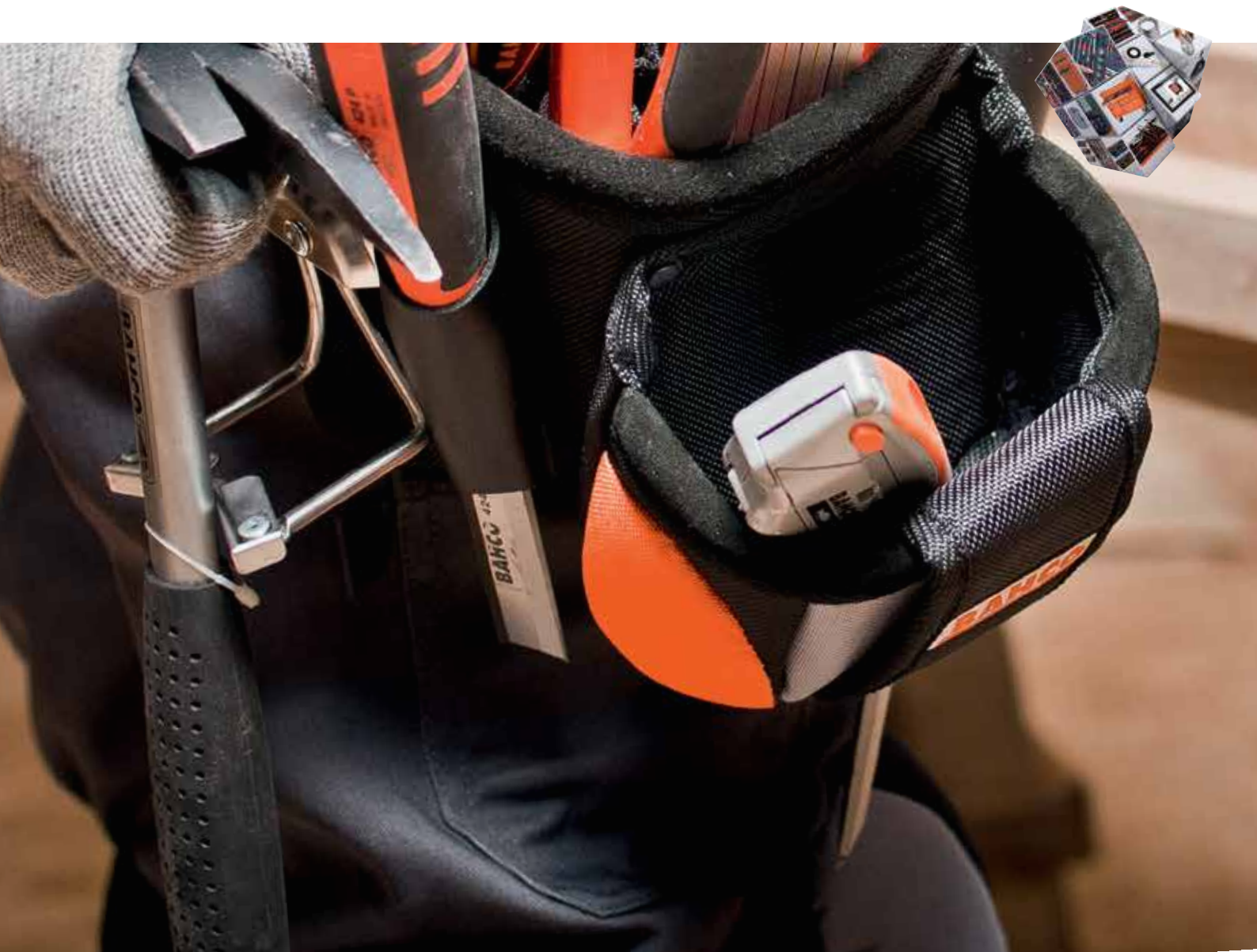

▶ TABLE OF CONTENT



Electrician's Pouch
4750-EP-1 p. 9



Drill Holster Right & Left Hand
4750-DHO-3 p. 10



Hammer Holder
4750-HHO-2 p. 11



Multi Purpose Holder
4750-MPH-1 p. 12



Universal Pouch
4750-UP-1 p. 13



Two Pocket Fixings Pouch
4750-2PP-1 p. 14



Vertical Smartphone Holder
4750-VMPH-1 p. 15



Knife Holder
4750-KNHO-1 p. 16



Knife Holder For ERGO™ Series
4750-KNHO-0 p. 17



Heavy Duty Belt With Cushion **4750-HDB-2 p. 18**



Quick Release Fabric Adjustable Belt
4750-QRFB-1 p. 19



Heavy Duty Leather Belt
4750-HDLB-1 p. 19



Heavy Duty Belt Set
4750-HDBS-2 p. 22

3 Pouch Belt Set
4750-3PB-1 p. 23



Tool Case Tube
4750-TOCST-1 p. 25



Folding Front Leather Tool Case
4750-FOLTC-1 p. 26



Roll Cover For Tools
4750-ROCO-1 p. 27



Lopper Holster
PROF-LOPP p. 28



Secateur Holster
PROF-SEC p. 29



Anti Slip Knee Pads
4750-KP-1 p. 30



Braces With Clips
4750-BWC-1 p. 31

▶ MATERIAL & TECHNICAL SOLUTIONS

The best materials and technologies to suit the needs of the user

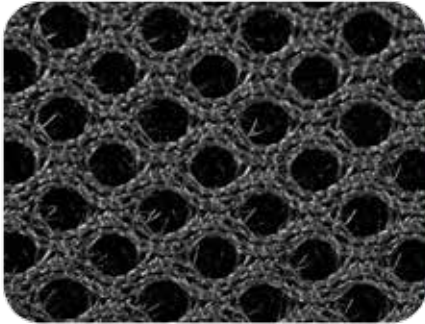

Black 3D Air Mesh



Polyester 600D

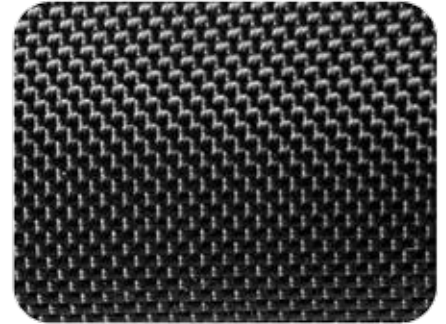

Polyester 1680D

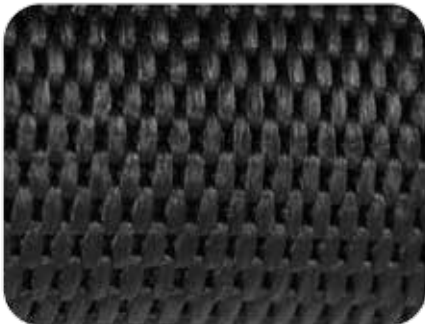

Polypropylene Tape



Polypropylene Sheet



High Grade Leather



Polypropylene Sheet

Synthetic Leather

Dual Layer of Waterproof material



Suede Leather

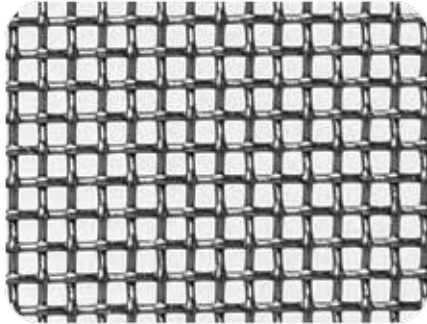

Net Pocket



Thick Foam

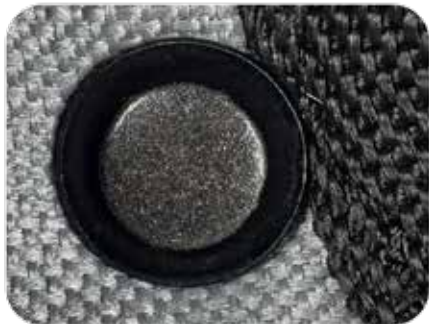

Black Rivets with Washers



Side Gate Hammer Holder



Cushioned Shoulder Pad



Measuring Tape Clip



Plastic Handle



Steel Buckle



High Quality Zipper



Lock with Key



Metal Buttons



▶ ELECTRICIAN'S POUCH

4750-EP-1

General features

Fits any Bahco tool belt or normal clothing belt. Universal tool loop for your bigger tools to keep them organized. Chain hook for an easy access to insulation tapes or flex. Main deep pocket for safe storage of long tools and fixings, etc. Additional pocket for smaller tools gives easy tool access. Real leather slots on the sides ideal for holding longer tools i.e. screwdrivers, knives. Necessary equipment is at hand when needed. Made of strong 1680 denier polyester.



Technical Information:

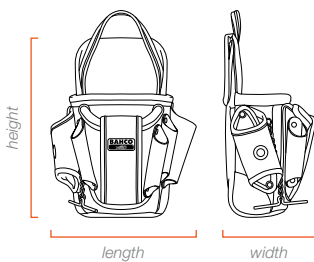

	<i>metric</i>
<i>height:</i>	300 mm
<i>length:</i>	270 mm
<i>width:</i>	150 mm
<i>weight:</i>	0,520 kg
<i>volume:</i>	2,500 l



Outside features:

Specifically researched design to carry a full range of specialized electrical tools.

▶ DRILL HOLSTER RIGHT & LEFT HAND

4750-DHO-3

General features

Holds any standard sized cordless or mains powered drills. Suits left and right handed users as well as forward and backward facing machines. Rubber slots on the top ideal for storing drill bits.

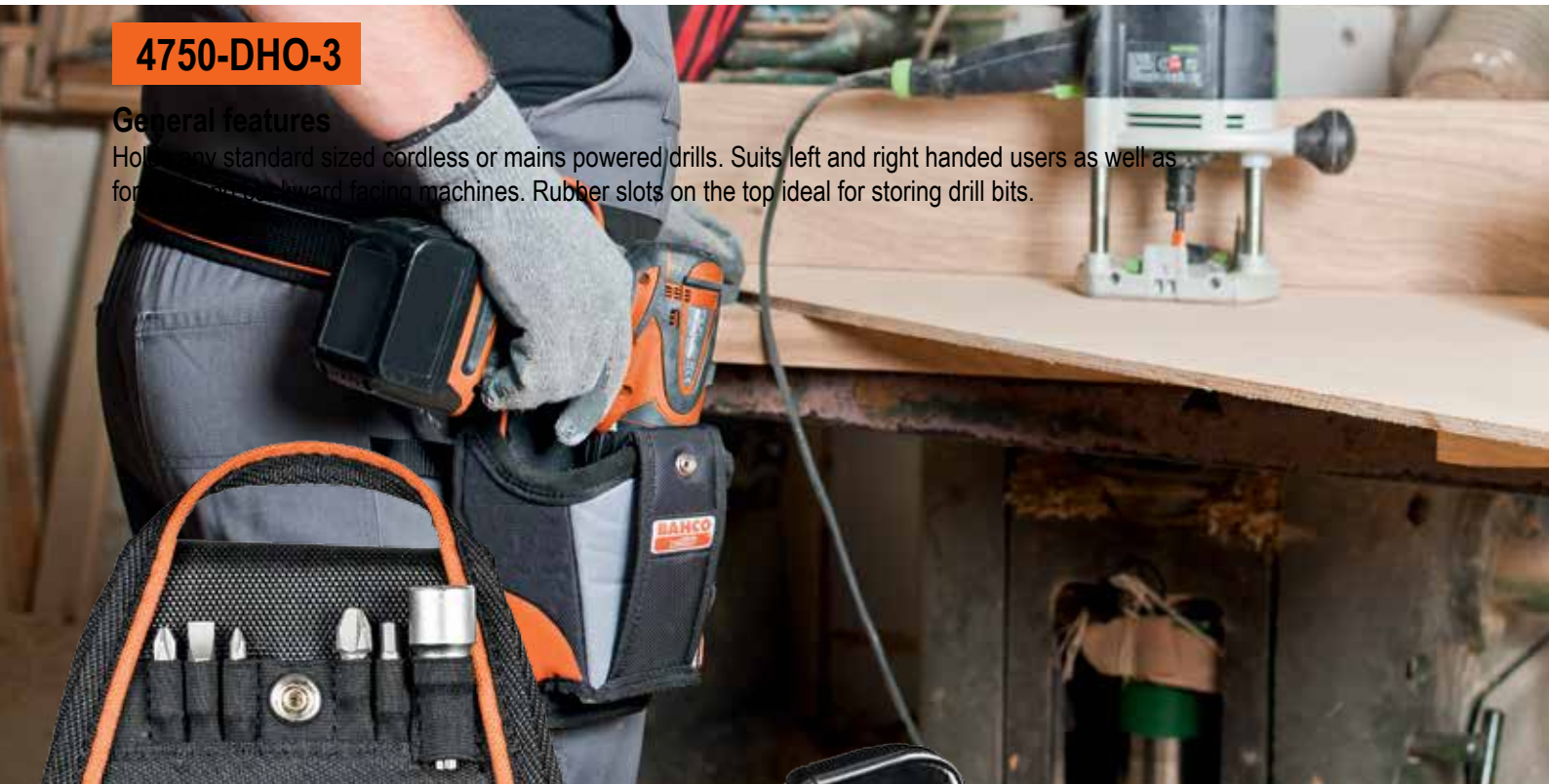

Technical Information:

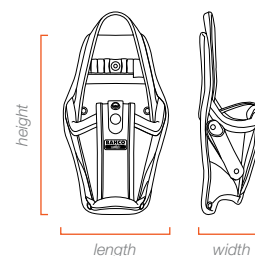

	metric
height:	290 mm
length:	170 mm
width:	90 mm
weight:	0,260 kg
volume:	01

Outside features:

Genuine leather strap with a metal button holds the drill safely when climbing on or off a scaffolding.

▶ HAMMER HOLDER

4750-HHO-2

General features

Fits any Bahco tool belt or normal clothing belt. Used while working with the hands up, when the quick access to tools is needed. Made of strong 1680 senior polyester. Swings to keep your hammer at a comfortable angle.



Outside features:

Solution with side gate lets you easily put the tool in without looking at the holder. Keeps all kinds of common hammers used on building site.



Technical Information:

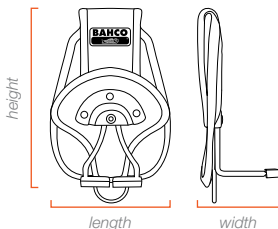

	metric
height:	180 mm
length:	120 mm
width:	70 mm
weight:	0,170 kg
volume:	0l



Includes ring for Tools at Height safety system

▶ MULTI PURPOSE HOLDER

4750-MPH-1

General features

Riveted for truly unbreakable strength. Measuring tape clip for any common builder's tape measure from 3 to 10 meters long. Made of strong 1680 denier polyester. Extra leather slot in the middle for a pen or a small screwdriver. Ideal item to be added to your own creation of Tool Belt Set together with other products.



Technical Information:

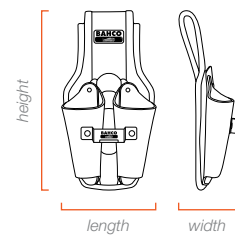

	metric
height:	240 mm
length:	170 mm
width:	60 mm
weight:	0,220 kg
volume:	01

Outside features:

Leather slots ideal for holding different types of tools i.e. knives, screwdrivers.

► UNIVERSAL POUCH

4750-UP-1

General features

Fits any Bahco tool belt or normal clothing belt. Riveted for truly unbreakable strength. Real leather slots ideal for holding longer tools. Elastic straps inside big pockets for better tool organization. Necessary equipment is at hand when needed. Measuring tape clip for any common builder's tape measure from 3 to 10 meters long. Made of strong 1680 denier polyester.



Technical Information:

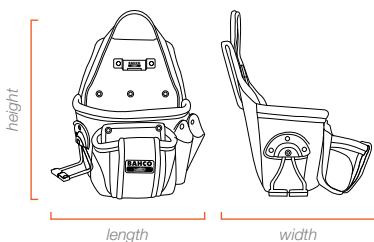

	<i>metric</i>
height:	260 mm
length:	290 mm
width:	180 mm
weight:	0,550 kg
volume:	2,000 l

Outside features:

Two deep multi-purpose open pockets provide for quick tool identification...



▶ TWO POCKET FIXINGS POUCH

4750-2PP-1

General features

Perfectly positioned wide pockets hold plenty of fixings and provide quick tool recognition. Fits any Bahco tool belt or normal clothing belt. Necessary equipment is at hand when needed. Made of strong 1680 denier polyester. Elastic straps inside big pockets for better tool organization.



Technical Information:

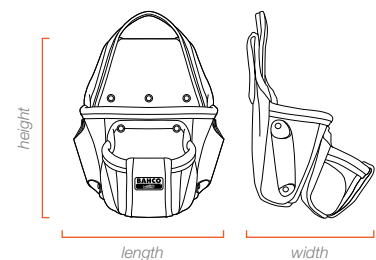

	metric
height:	260 mm
length:	260 mm
width:	180 mm
weight:	0,370 kg
volume:	2,000 l

Outside features:

General shape with rigid pocket sides designed to keep the pouch stable and vertical, preventing tools and fixings from falling out.

▶ VERTICAL SMARTPHONE HOLDER

4750-VMPH-1

General features

Closed by Velcro® for greater security. Made of strong 1680 denier polyester. Fits any belt from the Bahco range and the majority of the actual smartphones in the market. Fits any belt from the Collected Works also without the belt.



Technical Information:

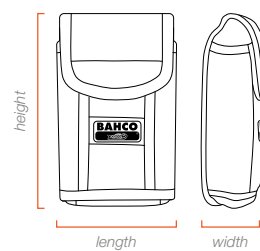

	<i>metric</i>
<i>height:</i>	160 mm
<i>length:</i>	100 mm
<i>width:</i>	35 mm
<i>weight:</i>	0,080 kg
<i>volume:</i>	0,120 l

Outside features:

Universal mobile phone holder with a flap for extra protection on a building site.

▶ KNIFE HOLDER

4750-KNHO-1

General features

Finished with an extra layer of suede leather to ensure resistance to years of wear and tear. Necessary equipment is at hand when needed. Riveted for truly unbreakable strength. Made of strong 1680 denier polyester. Fits any belt from the Collection.



Technical Information:

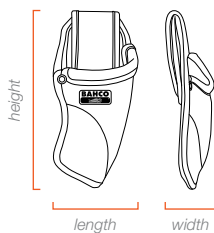

	metric
height:	200 mm
length:	100 mm
width:	50 mm
weight:	0,090 kg
volume:	0,100 l

Outside features:

Unique shape of this holder specifically designed to suit the utility knives



▶ KNIFE HOLDER FOR ERGO™ SERIES

4750-KNHO-0

General features

Fits perfectly into small knives. Necessary equipment is at hand when needed. Made of strong 600 denier polyester. Fits any belt from the Collection.



Technical Information:

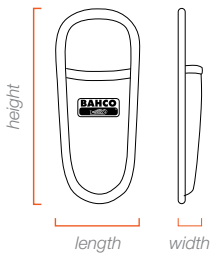

	metric
height:	210 mm
length:	85 mm
width:	20 mm
weight:	0,080 kg
volume:	0,080 l

▶ HEAVY DUTY BELT WITH CUSHION

4750-HDB-2

General features

Features a Heavy Duty Leather Belt with stainless steel twin-pin buckle. Made of strong 1680 Denier polyester with polyethylene backing. Riveted for truly unbreakable strength. Perfect foundation for building your customized tool belt. Fully padded by 3D mesh breathable material for extra comfort when carry the heaviest complement of tools and waist protection.



Technical Information:

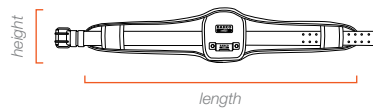

height:	190 mm
length:	900 mm
width:	50 mm
weight:	0,650 kg
volume:	0,250 l



▶ QUICK RELEASE FABRIC ADJUSTABLE BELT

4750-QRFB-1

General features

Fits perfectly into small knives. Necessary equipment is at hand when needed. Made of strong 600 denier polyester. Fits any belt from the Collection.



Technical Information:

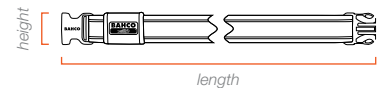

	metric
height:	50 mm
length:	1200 mm
width:	0 mm
weight:	0,310 kg
volume:	0l

▶ HEAVY DUTY LEATHER BELT

4750-HDLB-1

General features

Simple design and flexibility of the belts helps in easy using. Our belts are made of the high quality materials such as high grade leather or 1680 denier polyester. Our belts are design in the universal sizes so they fit any weight.

Technical Information:

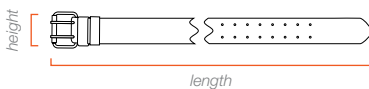

	metric
height:	50 mm
length:	1290 mm
width:	0 mm
weight:	0,300 kg
volume:	0l



▶ CREATE YOUR OWN TOOL BELT SET

1

Choose Pouches

Each Pouch is designed for different tools. Find out which tools you are using mostly and choose the best pouch.



Follow four easy steps to have your personalised tool belt set.



2 Add Belt

You have three different belts to choose from. The belt will be a base of your belt set.

3 Contact with Us

If you need any advice, we offer our wide experience in combining belts and pouches together. Just contact us and we will advise you how to create the most practical and useful tool belt set to suit your needs. Different kinds of jobs require different tools and consequently different carrying systems.

4 Get your own belt set

Now you are ready to use your own tool belt set according to your needs.



▶ HEAVY DUTY BELT SET

4750-HDBS-2

General features

The ultimate tool belt system is made from a combination of tough nylon and high grade plus synthetic stitching and riveted reinforcement. Moveable components, you can easily take out the pockets from the belt. Fully padded belt by 3D mesh breathable material for extra comfort when carrying heavy tools.



Technical Information:

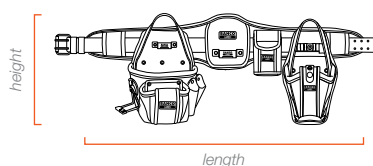

	<i>metric</i>
<i>height:</i>	360 mm
<i>length:</i>	900 mm
<i>width:</i>	160 mm
<i>weight:</i>	1,550 kg
<i>volume:</i>	2,250 l



Outside features:

Fits waist sizes from 80 cm to 120 cm (32" to 48")

▶ 3 POUCH BELT SET

4750-3PB-1

General features

5 handy pockets to cover most trade applications. Strong construction with riveted reinforcement – for true structural strength with galvanized washers top and bottom. Easy to adjust comfortable nylon belt with 50 mm polypropylene quick release buckle.

Outside features:

Strong construction with riveted reinforcement.



	<i>metric</i>
height:	260 mm
length:	650 mm
width:	180 mm
weight:	1,230 kg
volume:	4,500 l

Technical Information:

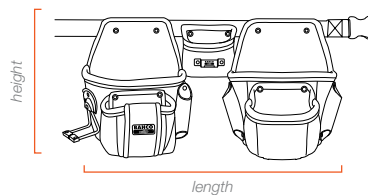



▶ TOOL CASE TUBE

4750-TOCST-1

General features

Made of synthetic leather. Long internal pocket in the main compartment. Rubber carry handle, simple alternative solution to carrying bag on your shoulder. Leather closing straps instead of metal locks let us adjust the bag for tools that might be even longer than a case and would stick out.



	<i>metric</i>
<i>height:</i>	260 mm
<i>length:</i>	500 mm
<i>width:</i>	270 mm
<i>weight:</i>	2,980 kg
<i>volume:</i>	24,000 l

Technical Information:

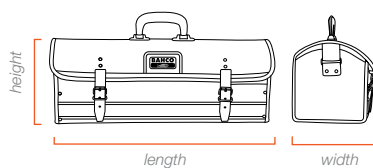

Outside features:
Perfect for storing long tools.

► FOLDING FRONT LEATHER TOOL CASE

4750-FOLTC-1

General features

Open design for quick and easy access. External pocket for documents. Adjustable heavy-duty shoulder belt, easy to unfasten when it is not needed. Shoulder pad makes carrying the bag nicer when it is full. Made of strong synthetic leather. Leather strap inside for better tool organization. Plastic handle enables carrying the bag when is full.



Technical Information:

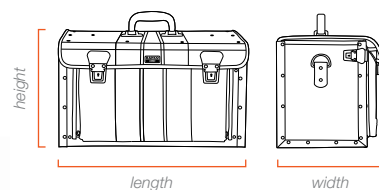

	metric
height:	260 mm
length:	440 mm
width:	210 mm
weight:	2,900 kg
volume:	22,000 l

Outside features:

Aluminum corner reinforcements for longer life of bag and protecting the front panel when it is opened on the floor.

▶ ROLL COVER FOR TOOLS

4750-ROCO-1

General features

Made of soft 1680D polyester. Designed to store all of the small tools and pieces of gear that seem to get lost in the bottom of bags. Elasticated tool securing band prevent tools from falling out giving you safety storage.



	<i>metric</i>
height:	380 mm
length:	320 mm
width:	50 mm
weight:	0,300 kg
volume:	01

Technical Information:

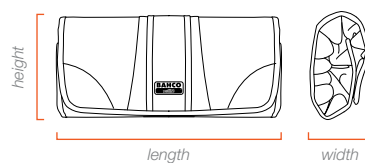

Outside features:

Velcro® system

▶ LOPPER HOLSTER

PROF-LOPP

General features

PVC coated polyester fabrics lining to give extra strength and protect the holster before damage in hard orchard conditions. Additionally this fabric doesn't tear when it is cut. Made of strong and durable 35mm width elastic rubber straps are easy to put on. Universal size thanks adjustable strong Velcro® tape stitched to each strap. Pocket on the front side for easy access to smaller tools or things. Perfect for sharpening stone. Also PVC coated polyester fabrics for longer life.



Technical Information:

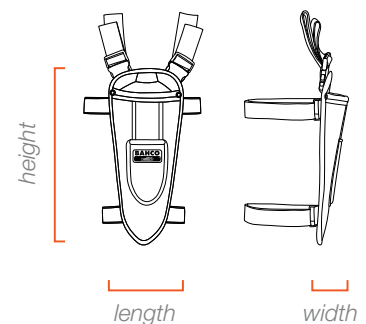

	metric
height:	370 mm
length:	160 mm
width:	50 mm
weight:	0,370 kg
volume:	0l

▶ SECATEUR HOLSTER

PROF-SEC

General features

Multipurpose – two pockets in two sizes. Most of basic tools used in Orchard or Garden can be put inside. Made of strong polyester 1680D. The pouch sits comfortably on any belt from the collection. Perfectly positioned two open pockets provide quick tool location and easy use.



Technical Information:

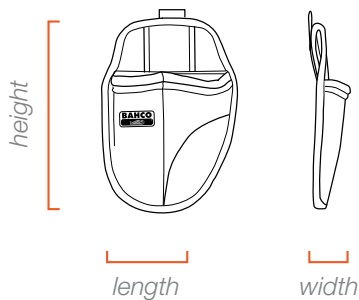

	metric
height:	230 mm
length:	160 mm
width:	50 mm
weight:	0,130 kg
volume:	0l

▶ ANTI SLIP KNEE PADS

4750-KP-1

General features

Universal lightweight knee pads for different kinds of surfaces. Heavy Duty rubber cups ensure comfort and safety when used in difficult conditions. Elastic straps with hook-and-loop fasteners for easy adjustment to leg sizes. Breathable 3D Air Mesh material lining provides maximum cushioning for all day of wearing.

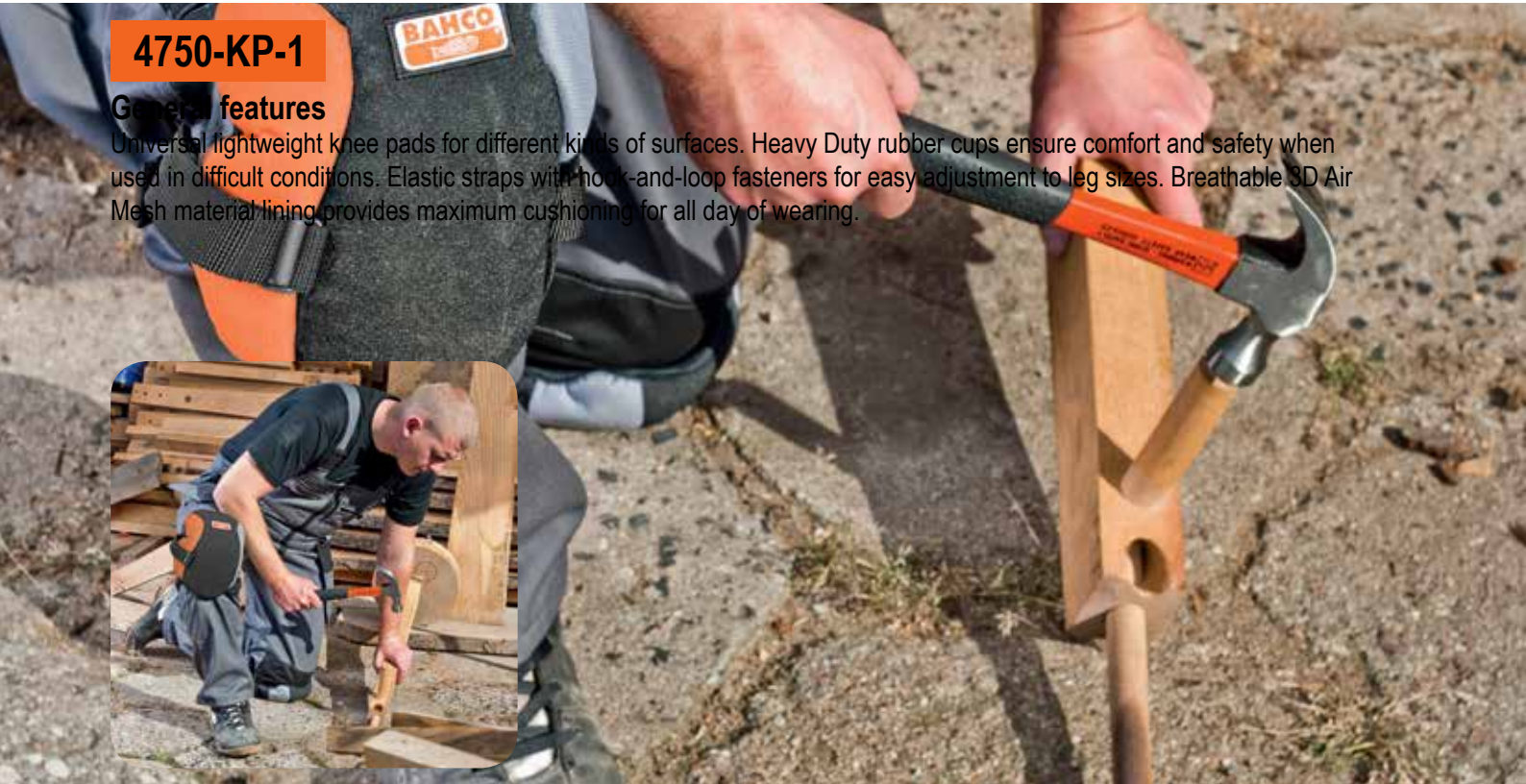

Outside features:

Flexible knee pads, made from rubber and polyester 1680 denier ideal for most applications including general construction, use on uneven surfaces and for laying carpets, floor tiles and flooring etc.



Technical Information:

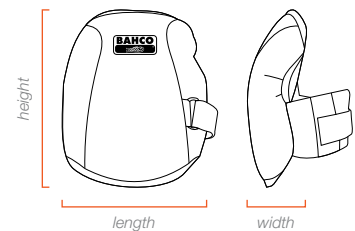

	metric
height:	160 mm
length:	220 mm
width:	70 mm
weight:	0,300 kg
volume:	01



▶ BRACES WITH CLIPS

4750-BWC-1

General features

Designed to transfer weight from waist to shoulders. Universal size. Fully cushioned pad provides for comfortable wearing. Heavy-duty steel fastening clips. Made of strong and durable elastic rubber.



Technical Information:

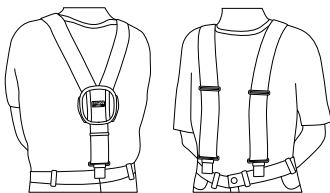

	<i>metric</i>
<i>height:</i>	<i>0 mm</i>
<i>length:</i>	<i>50 mm</i>
<i>width:</i>	<i>0 mm</i>
<i>weight:</i>	<i>0,200 kg</i>
<i>volume:</i>	<i>0 l</i>



Outside features:

Straps equipped with two metal buckles for perfect adaptation to the body shape.

PACKING INFORMATION

	<i>P-Number</i>	<i>Description</i>	<i>Quantity</i>	<i>Size of Box (mm)</i>	<i>Size of Box (in)</i>	<i>Gross Weight (kg)</i>	<i>Gross Weight (lb)</i>
1	4750-EP-1	Electrician's Pouch	35	780x590x440	30.75x23.25x17.25	20.20	44.53
2	4750-DHO-3	Drill Holster Right & Left Hand	40	590x390x440	23.25x15.25x17.25	10.50	23.15
3	4750-HHO-2	Hammer Holder	70	590x390x220	23.25x15.25x8.75	12.10	26.67
4	4750-MPH-1	Multi Purpose Holder	60	590x390x440	23.25x15.25x17.25	14.50	31.97
5	4750-UP-1	Universal Pouch	35	780x590x440	30.75x23.25x17.25	18.10	39.90
6	4750-2PP-1	Two Pocket Fixings Pouch	40	780x590x440	30.75x23.25x17.25	16.80	37.04
7	4750-VMPH-1	Vertical Smartphone Holder	120	590x390x440	23.25x15.25x17.25	13.30	29.32
8	4750-KNHO-1	Knife Holder	100	590x390x220	23.25x15.25x8.75	9.90	21.82
9	4750-KNHO-0	Knife Holder For ERGO™ Series	250	590x390x220	23.25x15.25x8.75	20.90	46.08
10	4750-HDB-2	Heavy Duty Belt With Cushion	25	590x390x440	23.25x15.25x17.25	16.30	35.93
11	4750-QRFB-1	Quick Release Fabric Adjustable Belt	80	590x390x440	23.25x15.25x17.25	20.50	45.19
12	4750-HDLB-1	Heavy Duty Leather Belt	40	590x390x220	23.25x15.25x8.75	12.50	27.55
13	4750-HDBS-2	Heavy Duty Belt Set	15	780x590x440	30.75x23.25x17.25	20.30	44.75
14	4750-3PB-1	3 Pouch Belt Set	20	780x590x440	30.75x23.25x17.25	18.40	40.56
15	4750-TOCST-1	Tool Case Tube	8	780x590x440	30.75x23.25x17.25	13.20	29.10
16	4750-FOLTC-1	Folding Front Leather Tool Case	16	1180x780x560	46.50x30.75x22.00	48.50	106.92
17	4750-ROCO-1	Roll Cover For Tools	50	590x390x440	23.25x15.25x17.25	16.30	35.93
18	PROF-LOPP	Lopper Holster	70	780x590x440	30.75x23.25x17.25	27.90	61.51
19	PROF-SEC	Secateur Holster	70	590x390x440	23.25x15.25x17.25	10.40	22.93
20	4750-KP-1	Anti Slip Knee Pads	40	590x390x440	23.25x15.25x17.25	13.70	30.20
21	4750-BWC-1	Braces With Clips	30	590x390x220	23.25x15.25x8.75	6.90	15.21



www.bahco.com



ERGO TOOL MANAGEMENT SYSTEM

Bahco has developed a new Modular System based on: Aviation, Auto Repair, Industrial Maintenance, General Industry and other Critical Industries.

Thanks to the new Modular System, customer will be able to create his own composition by using 1/3, 2/3 and 3/3 modules. Bahco offers 141 modules with following split:

49 modules **1/3**

26 modules **2/3**

71 modules **3/3**

In case customer wants to further customize any of those 141 modules; BETMS configurator gives the option of ungrouping them and building up a customized composition based on the Bahco Handtools and Metal Cutting Tools Assortment.

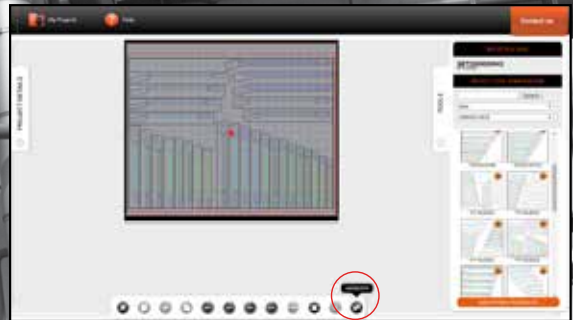
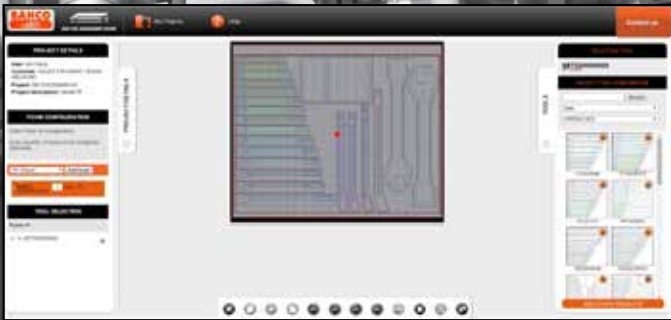

These range of modules have been developed and it is based on 26" Bahco Trolleys:



181 mm 1/3
362 mm 2/3
543 mm 3/3



Inlays properties

- 100% FOD
- Extra deeper hole in the insert facilitates to take out the tool
- Underlay is red, overlay is black. A visible red, means that a tool is missing
- You can easily identify the missing tool thanks to the accurately designed shape
- Resistant to oil and grease
- Easy to clean



MIX

1/3 MODULE MIX COMPOSITION



ERGO TOOL MANAGEMENT SYSTEM

**FF1E5001 - 7 pcs**

MTB-5-25 5M TAPE MEASURE 26 mm
 8045LVDE VOLTAGE TESTER VDE 0.5 X 3.5 X 42
 WR2-MM 2M MM ONLY WOOD RULE
 1544 FEELER GAUGE
 1178-SCRIBE SCRIBER CARB.TUNGSTEN
 5515T TELESCOPIC MIRROR
 1150D DIGITAL CALIPER

**FF1E5002 - 11 pcs**

3740-150 FLAT CHISEL
 3740-175 FLAT CHISEL
 3740-200 FLAT CHISEL
 3734-2 COTTER PIN PUNCH
 3734-3 COTTER PIN PUNCH
 3734-4 COTTER PIN PUNCH
 3734-5 COTTER PIN PUNCH
 3734-6 COTTER PIN PUNCH
 3734-8 COTTER PIN PUNCH
 481-100 GERMAN DIN HAMMER
 1157 AUTOMATIC CENTER PUNCH

**FF1E5003 - 11 pcs**

481-300 GERMAN DIN HAMMER
 3735-5-120 CENTRE PUNCH
 3739-300 POINTED CHISEL
 3740-100 FLAT CHISEL
 3740-150 FLAT CHISEL
 3740-200 FLAT CHISEL
 3740-125 FLAT CHISEL
 3733-2 DRIFT PUNCH
 3733-3 DRIFT PUNCH
 3733-4 DRIFT PUNCH
 3733-5 DRIFT PUNCH

SOCKETS

1/3 MODULE SOCKETS AND ACCESSORIES COMPOSITION

1/4 Sockets and accessories



FF1E2001 - 37 pcs

6700SM-10 SOCKET 1/4
 6700SM-11 SOCKET 1/4
 6700SM-12 SOCKET 1/4
 6700SM-13 SOCKET 1/4
 6700SM-14 SOCKET 1/4
 6700SM-4 SOCKET 1/4
 6700SM-5 SOCKET 1/4
 6700SM-5.5 SOCKET 1/4
 6700SM-6 SOCKET 1/4
 6700SM-7 SOCKET 1/4
 6700SM-8 SOCKET 1/4
 6700SM-9 SOCKET 1/4
 6700TORX-E10 SOCKET 1/4
 6700TORX-E4 SOCKET 1/4
 6700TORX-E5 SOCKET 1/4
 6700TORX-E6 SOCKET 1/4
 6700TORX-E7 SOCKET 1/4
 6700TORX-E8 SOCKET 1/4

6709M-3 SOCKET 1/4

6709M-4 SOCKET 1/4

6709M-5 SOCKET 1/4

6709M-6 SOCKET 1/4

6709M-8 SOCKET 1/4

6709TORX-T10 SOCKET 1/4

6709TORX-T15 SOCKET 1/4

6709TORX-T20 SOCKET 1/4

6709TORX-T25 SOCKET 1/4

6709TORX-T27 SOCKET 1/4

6709TORX-T30 SOCKET 1/4

6709TORX-T40 SOCKET 1/4

6709TORX-T8 SOCKET 1/4

6709TORX-T9 SOCKET 1/4

6950SL RATCHET 1/4, SLIM HEAD 72T

6954 T-HANDLE 1/4

6956 NUT DRIVER 1/4

6960 EXTENSION 1/4

6966 UNIVERSAL JOINT 1/4



FF1E2002 - 45 pcs

6700SM-4 SOCKET 1/4

6700SM-4.5 SOCKET 1/4

6700SM-5 SOCKET 1/4

6700SM-5.5 SOCKET 1/4

6700SM-6 SOCKET 1/4

6700SM-7 SOCKET 1/4

6700SM-8 SOCKET 1/4

6700SM-9 SOCKET 1/4

6700SM-10 SOCKET 1/4

6700SM-11 SOCKET 1/4

6700SM-12 SOCKET 1/4

6700SM-13 SOCKET 1/4

6700SM-14 SOCKET 1/4

6709PZ-1 SOCKET 1/4

6709PZ-2 SOCKET 1/4

6709PZ-3 SOCKET 1/4

6709PH-1 SOCKET 1/4

6709PH-2 SOCKET 1/4

6709PH-3 SOCKET 1/4

6709TORX-T10 SOCKET 1/4

6709TORX-T15 SOCKET 1/4

6709TORX-T20 SOCKET 1/4

6709TORX-T25 SOCKET 1/4

6709TORX-T30 SOCKET 1/4

6709TORX-T40 SOCKET 1/4

SOCKETS

1/3 MODULE SOCKETS AND ACCESORIES COMPOSITION

• 1/4 Sockets and accessories



ERGO TOOL MANAGEMENT SYSTEM



FF1E2002 - 45 pcs

6709F-4.5 SOCKET 1/4
 6709F-5.5 SOCKET 1/4
 6709F-8 SOCKET 1/4
 6709M-3 SOCKET 1/4
 6709M-4 SOCKET 1/4
 6709M-5 SOCKET 1/4
 6709M-6 SOCKET 1/4
 6709M-8 SOCKET 1/4
 1998M-1.5 OFFSET KEY NICKEL 1.5 mm
 1998M-2 OFFSET KEY NICKEL 2 mm
 1998M-2.5 OFFSET KEY NICKEL 2.5 mm
 1998M-3 OFFSET KEY NICKEL 3 mm
 6950SL RATCHET 1/4, SLIM HEAD 72T
 6966 UNIVERSAL JOINT 1/4
 6962-W WOBBLE EXTENSION 1/4" 150 mm
 6956 NUT DRIVER 1/4
 6960 EXTENSION 1/4
 6961 EXTENSION 1/4
 7765 ADAPTOR 1/4
 6954 T-HANDLE 1/4



FF1E2003 - 27 pcs

6700SM-5 SOCKET 1/4
 6700SM-5.5 SOCKET 1/4
 6700SM-6 SOCKET 1/4
 6700SM-7 SOCKET 1/4
 6700SM-8 SOCKET 1/4
 6700SM-9 SOCKET 1/4
 6700SM-10 SOCKET 1/4
 6700SM-11 SOCKET 1/4
 6700SM-12 SOCKET 1/4
 6700SM-13 SOCKET 1/4
 6700SM-14 SOCKET 1/4
 BE-9776 SCREWDR SET HEX NICK. 9 PCS
 6950SL RATCHET 1/4, SLIM HEAD 72T
 6956 NUT DRIVER 1/4
 6962 EXTENSION 1/4
 6966 UNIVERSAL JOINT 1/4
 7765 ADAPTOR 1/4
 6954 T-HANDLE 1/4
 1997M-12 SCREWDR OFFSET 1997M HEX 12



FF1E2004 - 48 pcs

A6700DM-5 BSOCKET 1/4, LONG
 A6700DM-5.5 SOCKET 1/4, LONG
 A6700DM-6 SOCKET 1/4, LONG
 A6700DM-7 SOCKET 1/4, LONG
 A6700DM-8 SOCKET 1/4, LONG
 A6700DM-9 SOCKET 1/4, LONG
 A6700DM-10 SOCKET 1/4, LONG
 A6700DM-11 SOCKET 1/4, LONG
 A6700DM-12 SOCKET 1/4, LONG
 A6700DM-13 SOCKET 1/4, LONG
 A6700DM-14 SOCKET 1/4, LONG
 59S/31-1 BITS SET 31PCS PH,PZ,THEX,SL
 80805GS STUBBY RATCHETING SCREWDRIVER
 6950SL RATCHET 1/4, SLIM HEAD 72T
 6966 UNIVERSAL JOINT 1/4
 6972H POWER SOCKET HOLDER 1/4
 6962 EXTENSION 1/4
 7765 ADAPTOR 1/4

SOCKETS

1/3 MODULE SOCKETS AND ACCESSORIES COMPOSITION

1/4 Sockets and accessories



FF1E2005 - 17 pcs

6700SM-5.5 SOCKET 1/4
 6700SM-6 SOCKET 1/4
 6700SM-7 SOCKET 1/4
 6700SM-8 SOCKET 1/4
 6700SM-9 SOCKET 1/4
 6700SM-10 SOCKET 1/4
 6700SM-11 SOCKET 1/4
 6700SM-12 SOCKET 1/4
 6700SM-13 SOCKET 1/4
 6700SM-14 SOCKET 1/4
 6950RN RATCHET 1/4
 6962 EXTENSION 1/4
 6966 UNIVERSAL JOINT 1/4
 6960 EXTENSION 1/4
 6954 T-HANDLE 1/4
 6956 NUT DRIVER 1/4
 6972H POWER SOCKET HOLDER 1/4



FF1E2006 - 35 pcs

6700SZ-5/16 SOCKET 1/4
 6700SZ-5/32 SOCKET 1/4
 6700SZ-11/32 SOCKET 1/4
 6700SZ-7/16 SOCKET 1/4
 6700SZ-9/32 SOCKET 1/4
 6700SZ-3/16 SOCKET 1/4
 6700SZ-3/8 SOCKET 1/4
 6700SZ-7/32 SOCKET 1/4
 6700SZ-1/4 SOCKET 1/4
 6700SZ-1/2 SOCKET 1/4
 6700SZ-9/16 SOCKET 1/4
 6709PZ-1 SOCKET 1/4
 6709PZ-2 SOCKET 1/4
 6709PZ-3 SOCKET 1/4
 6709PH-1 SOCKET 1/4
 6709PH-2 SOCKET 1/4
 6709PH-3 SOCKET 1/4
 6709TORX-T8 SOCKET 1/4
 6709TORX-T10 SOCKET 1/4
 6709TORX-T15 SOCKET 1/4
 6709TORX-T20 SOCKET 1/4
 6709TORX-T25 SOCKET 1/4
 6709TORX-T30 SOCKET 1/4
 6709F-4.5 SOCKET 1/4
 6709F-6.5 SOCKET 1/4
 6709F-8 SOCKET 1/4
 6950RN RATCHET 1/4

6954 T-HANDLE 1/4
 6972H POWER SOCKET HOLDER 1/4
 6960 EXTENSION 1/4
 6962 EXTENSION 1/4
 6963 EXTENSION, FLEX 1/4
 6966 UNIVERSAL JOINT 1/4
 6956 NUT DRIVER 1/4
 7765 ADAPTOR 1/4

SOCKETS

1/3 MODULE SOCKETS AND ACCESORIES COMPOSITION

• 1/4 and 3/8 sockets and accessories



ERGO TOOL MANAGEMENT SYSTEM



FF1E2007 - 24 pcs

6700SZ-9/32 SOCKET 1/4
 6700SZ-3/16 SOCKET 1/4
 6700SZ-3/8 SOCKET 1/4
 6700SZ-1/4 SOCKET 1/4
 6700SZ-7/16 SOCKET 1/4
 6700SZ-7/32 SOCKET 1/4
 6700SZ-1/2 SOCKET 1/4
 6700SZ-11/32 SOCKET 1/4
 1995Z-5/64 OFFSET SCREWDRIVER BLACK 5/64
 1995Z-5/32 OFFSET SCREWDRIVER BLACK 5/32
 1995Z-3/8 OFFSET SCREWDRIVER BLACK 3/8
 1995Z-3/32 OFFSET SCREWDRIVER BLACK 3/32
 1995Z-7/32 OFFSET SCREWDRIVER BLACK 7/32
 1995Z-1/8 OFFSET SCREWDRIVER BLACK 1/8
 1995Z-5/16 OFFSET SCREWDRIVER BLACK 5/16
 1995Z-3/16 OFFSET SCREWDRIVER BLACK 3/16
 1995Z-1/4 OFFSET SCREWDRIVER BLACK 1/4
 6950RN RATCHET 1/4
 6954 T-HANDLE 1/4
 6972H POWER SOCKET HOLDER 1/4
 6960 EXTENSION 1/4
 6962 EXTENSION 1/4
 6956 NUT DRIVER 1/4
 6966 UNIVERSAL JOINT 1/4



FF1E2008 - 26 pcs

6700SM-5.5 SOCKET 1/4
 6700SM-6 SOCKET 1/4
 6700SM-7 SOCKET 1/4
 6700SM-8 SOCKET 1/4
 6700SM-9 SOCKET 1/4
 6700SM-10 SOCKET 1/4
 6700SM-11 SOCKET 1/4
 6700SM-12 SOCKET 1/4
 6700SM-13 SOCKET 1/4
 6700SM-14 SOCKET 1/4
 1995M-2 OFFSET SCREWDRIVER BLACK 2 mm
 1995M-3 OFFSET SCREWDRIVER BLACK 3 mm
 1995M-4 OFFSET SCREWDRIVER BLACK 4 mm
 1995M-5 OFFSET SCREWDRIVER BLACK 5 mm
 1995M-6 OFFSET SCREWDRIVER BLACK 6 mm
 1995M-7 OFFSET SCREWDRIVER BLACK 7 mm
 1995M-8 OFFSET SCREWDRIVER BLACK 8 mm
 1995M-9 OFFSET SCREWDRIVER BLACK 9 mm
 1995M-10 OFFSET SCREWDRIVER BLACK 10 mm
 6950RN RATCHET 1/4
 6960 EXTENSION 1/4
 6962 EXTENSION 1/4
 6956 UNIVERSAL JOINT 1/4
 6954 T-HANDLE 1/4
 6956 NUT DRIVER 1/4
 6972H POWER SOCKET HOLDER 1/4



FF1E2101 - 24 pcs

7400SM-6 SOCKET 3/8
 7400SM-7 SOCKET 3/8
 7400SM-8 SOCKET 3/8
 7400SM-9 SOCKET 3/8
 7400SM-10 SOCKET 3/8
 7400SM-11 SOCKET 3/8
 7400SM-12 SOCKET 3/8
 7400SM-13 SOCKET 3/8
 7400SM-14 SOCKET 3/8
 7400SM-15 SOCKET 3/8
 7400SM-16 SOCKET 3/8
 7400SM-17 SOCKET 3/8
 7400SM-18 SOCKET 3/8
 7400SM-19 SOCKET 3/8
 7400SM-20 SOCKET 3/8
 7400SM-22 SOCKET 3/8
 7750SL RATCHET 3/8, SLIM HEAD 72T
 7760 EXTENSION 3/8
 7761 EXTENSION 3/8
 7762 EXTENSION 3/8
 7764 ADAPTOR 3/8
 8164-1/2 ADAPTOR 3/8
 7766 UNIVERSAL JOINT 3/8
 7754 T-HANDLE 3/8

SOCKETS

1/3 MODULE SOCKETS AND ACCESSORIES COMPOSITION

3/8 sockets and accessories



FF1E2102 - 25 pcs

- 7400SM-6 SOCKET 3/8
- 7400SM-7 SOCKET 3/8
- 7400SM-8 SOCKET 3/8
- 7400SM-9 SOCKET 3/8
- 7400SM-10 SOCKET 3/8
- 7400SM-11 SOCKET 3/8
- 7400SM-12 SOCKET 3/8
- 7400SM-13 SOCKET 3/8
- 7400SM-14 SOCKET 3/8
- 7400SM-15 SOCKET 3/8
- 7400SM-16 SOCKET 3/8
- 7400SM-17 SOCKET 3/8
- 7400SM-18 SOCKET 3/8
- 7400SM-19 SOCKET 3/8
- 7409M-4 SOCKET 3/8 HEX
- 7409M-5 SOCKET 3/8 HEX
- 7409M-6 SOCKET 3/8 HEX
- 7409M-8 SOCKET 3/8 HEX
- 7409M-10 SOCKET 3/8 HEX
- 7750SL RATCHET 3/8, SLIM HEAD 72T
- 7760 EXTENSION 3/8
- 7762 EXTENSION 3/8
- 7754 T-HANDLE 3/8
- 8164-1/2 ADAPTOR
- 7768 SMOOTH OPERATION U.JOINT - 3/8



FF1E2103 - 28 pcs

- 7400SM-7 SOCKET 3/8
- 7400SM-8 SOCKET 3/8
- 7400SM-9 SOCKET 3/8
- 7400SM-10 SOCKET 3/8
- 7400SM-11 SOCKET 3/8
- 7400SM-12 SOCKET 3/8
- 7400SM-13 SOCKET 3/8
- 7400SM-14 SOCKET 3/8
- 7400SM-15 SOCKET 3/8
- 7400SM-16 SOCKET 3/8
- 7400SM-17 SOCKET 3/8
- 7400SM-18 SOCKET 3/8
- 7400SM-19 SOCKET 3/8
- 7400SM-20 SOCKET 3/8
- 7400SM-21 SOCKET 3/8
- 7400SM-22 SOCKET 3/8
- 7400TORX-E8 SOCKET 3/8
- 7400TORX-E10 SOCKET 3/8
- 7400TORX-E12 SOCKET 3/8
- 7400TORX-E14 SOCKET 3/8
- 7400TORX-E16 SOCKET 3/8
- 7400TORX-E18 SOCKET 3/8
- 7750SL RATCHET 3/8, SLIM HEAD 72T
- 7760 EXTENSION 3/8
- 7762 EXTENSION 3/8
- 7768 SMOOTH OPERATION U.JOINT - 3/8
- 7766 UNIVERSAL JOINT 3/8
- SBS705 BAHCO BREAKER BAR 3/8



FF1E2104 - 20 pcs

- 7400SM-6 SOCKET 3/8
- 7400SM-8 SOCKET 3/8
- 7400SM-9 SOCKET 3/8
- 7400SM-10 SOCKET 3/8
- 7400SM-11 SOCKET 3/8
- 7400SM-12 SOCKET 3/8
- 7400SM-13 SOCKET 3/8
- 7400SM-14 SOCKET 3/8
- 7400SM-15 SOCKET 3/8
- 7400SM-16 SOCKET 3/8
- 7400SM-17 SOCKET 3/8
- 7400SM-18 SOCKET 3/8
- 7400SM-19 SOCKET 3/8
- 7400SM-20 SOCKET 3/8
- 7400SM-22 SOCKET 3/8
- 7750RN RATCHET 3/8
- 7761 EXTENSION 3/8
- 7762 EXTENSION 3/8
- 7766 UNIVERSAL JOINT 3/8
- 7768 SMOOTH OPERATION U.JOINT 3/8

SOCKETS

1/3 MODULE SOCKETS AND ACCESORIES COMPOSITION

• 3/8 and 1/2 sockets and accessories



ERGO TOOL MANAGEMENT SYSTEM



FF1E2105 - 28 pcs

740TORX-E8 SOCKET 3/8
 740TORX-E10 SOCKET 3/8
 740TORX-E11 SOCKET 3/8
 740TORX-E12 SOCKET 3/8
 740TORX-E14 SOCKET 3/8
 740TORX-E16 SOCKET 3/8
 740TORX-E18 SOCKET 3/8
 740TORX-T25 SOCKET 3/8
 740TORX-T25-L SOCKET 3/8 140 mm
 740TORX-T30 SOCKET 3/8
 740TORX-T30-L SOCKET 3/8 140 mm
 740TORX-T40 SOCKET 3/8
 740TORX-T40-L SOCKET 3/8 140 mm
 740TORX-T45 SOCKET 3/8
 740TORX-T45-L SOCKET 3/8 140 mm
 740TORX-T50 SOCKET 3/8
 740TORX-T50-L SOCKET 3/8 140 mm
 740SM-4 SOCKET 3/8 HEX
 740SM-5 SOCKET 3/8 HEX
 740SM-6 SOCKET 3/8 HEX
 740SM-8 SOCKET 3/8 HEX
 740SM-10 SOCKET 3/8 HEX
 7409F-6.5 SOCKET 3/8 FLAT TIP
 7409F-9 SOCKET 3/8 FLAT TIP
 7409F-10 SOCKET 3/8 FLAT TIP
 7409PH-1 SOCKET 3/8 PHILLIPS
 7409PH-2 SOCKET 3/8 PHILLIPS
 7409PH-3 SOCKET 3/8 PHILLIPS



FF1E2201 - 21 pcs

7800SM-10 SOCKET 1/2
 7800SM-11 SOCKET 1/2
 7800SM-12 SOCKET 1/2
 7800SM-13 SOCKET 1/2
 7800SM-14 SOCKET 1/2
 7800SM-15 SOCKET 1/2
 7800SM-17 SOCKET 1/2
 7800SM-18 SOCKET 1/2
 7800SM-19 SOCKET 1/2
 7800SM-20 SOCKET 1/2
 7800SM-21 SOCKET 1/2
 7800SM-22 SOCKET 1/2
 7800SM-24 SOCKET 1/2
 7800SM-27 SOCKET 1/2
 7805SM-16 SOCKET DEEP 1/2
 7805SM-21 SOCKET DEEP 1/2
 8150SL RATCHET 1/2, SLIM HEAD 72T
 8160-1/2 EXTENSION 1/2
 8162-1/2 EXTENSION 1/2
 8166-1/2 UNIVERSAL JOINT 1/2
 8165-1/2 ADAPTOR 1/2



FF1E2202 - 21 pcs

7800SM-8 SOCKET 1/2
 7800SM-9 SOCKET 1/2
 7800SM-10 SOCKET 1/2
 7800SM-11 SOCKET 1/2
 7800SM-12 SOCKET 1/2
 7800SM-13 SOCKET 1/2
 7800SM-14 SOCKET 1/2
 7800SM-15 SOCKET 1/2
 7800SM-16 SOCKET 1/2
 7800SM-17 SOCKET 1/2
 7800SM-18 SOCKET 1/2
 7800SM-19 SOCKET 1/2
 7800SM-20 SOCKET 1/2
 7800SM-21 SOCKET 1/2
 7800SM-23 SOCKET 1/2
 7800SM-24 SOCKET 1/2
 7800SM-27 SOCKET 1/2
 8150-1/2 RATCHET 1/2
 8160-1/2 EXTENSION 1/2
 8162-1/2 EXTENSION 1/2
 8166-1/2 UNIVERSAL JOINT 1/2

SOCKETS

1/3 MODULE SOCKETS AND ACCESSORIES COMPOSITION

▪ 1/2 sockets and accessories



FF1E2203 - 22 pcs

- 7800SM-8 SOCKET 1/2
- 7800SM-9 SOCKET 1/2
- 7800SM-10 SOCKET 1/2
- 7800SM-11 SOCKET 1/2
- 7800SM-12 SOCKET 1/2
- 7800SM-13 SOCKET 1/2
- 7800SM-14 SOCKET 1/2
- 7800SM-15 SOCKET 1/2
- 7800SM-16 SOCKET 1/2
- 7800SM-17 SOCKET 1/2
- 7800SM-18 SOCKET 1/2
- 7800SM-19 SOCKET 1/2
- 7800SM-21 SOCKET 1/2
- 7800SM-22 SOCKET 1/2
- 7800SM-24 SOCKET 1/2
- 7800SM-27 SOCKET 1/2
- 7800SM-30 SOCKET 1/2
- 7800SM-32 SOCKET 1/2
- 8150RN-1/2 RATCHET ROUND 1/2
- 8160-1/2 EXTENSION 1/2
- 8162-1/2 EXTENSION 1/2
- 8166-1/2 UNIVERSAL JOINT 1/2



FF1E2204 - 15 pcs

- 7800DZ-1/2 SOCKET 1/2
- 7800DZ-3/4 SOCKET 1/2
- 7800DZ-19/32 SOCKET 1/2
- 7800DZ-7/8 SOCKET 1/2
- 7800DZ-7/16 SOCKET 1/2
- 7800DZ-11/16 SOCKET 1/2
- 7800DZ-9/16 SOCKET 1/2
- 7800DZ-13/16 SOCKET 1/2
- 7800DZ-3/8 SOCKET 1/2
- 7800DZ-5/8 SOCKET 1/2
- 7800DZ-15/16 SOCKET 1/2
- 8150RN-1/2 RATCHET 1/2
- 8160-1/2 EXTENSION 1/2
- 8162-1/2 EXTENSION 1/2
- 8166-1/2 UNIVERSAL JOINT 1/2



FF1E2205 - 28 pcs

- 7800DM-10 SOCKET 1/2
- 7800DM-11 SOCKET 1/2
- 7800DM-12 SOCKET 1/2
- 7800DM-13 SOCKET 1/2
- 7800DM-14 SOCKET 1/2
- 7800DM-15 SOCKET 1/2
- 7800DM-16 SOCKET 1/2
- 7800DM-17 SOCKET 1/2
- 7800DM-18 SOCKET 1/2
- 7800DM-19 SOCKET 1/2
- 7800DM-20 SOCKET 1/2
- 7800DM-21 SOCKET 1/2
- 7800DM-22 SOCKET 1/2
- 7800DM-23 SOCKET 1/2
- 7800DM-24 SOCKET 1/2
- 7800DM-25 SOCKET 1/2
- 7800DM-26 SOCKET 1/2
- 7800DM-27 SOCKET 1/2
- 7800DM-28 SOCKET 1/2
- 7800DM-30 SOCKET 1/2
- 7800DM-32 SOCKET 1/2
- 7809M-5 SOCKET 1/2
- 7809M-7 SOCKET 1/2
- 7809M-8 SOCKET 1/2
- 7809M-9 SOCKET 1/2
- 7809M-10 SOCKET 1/2
- 7809M-12 SOCKET 1/2
- 7809M-14 SOCKET 1/2

SOCKETS

1/3 MODULE SOCKETS AND ACCESORIES COMPOSITION

▪ 1/2 sockets and accessories



ERGO TOOL MANAGEMENT SYSTEM



FF1E2206 - 27 pcs

7800SM-10 SOCKET 1/2
7800SM-11 SOCKET 1/2
7800SM-12 SOCKET 1/2
7800SM-13 SOCKET 1/2
7800SM-14 SOCKET 1/2
7800SM-15 SOCKET 1/2
7800SM-16 SOCKET 1/2
7800SM-17 SOCKET 1/2
7800SM-18 SOCKET 1/2
7800SM-19 SOCKET 1/2
7800SM-20 SOCKET 1/2
7800SM-21 SOCKET 1/2
7800SM-22 SOCKET 1/2
7800SM-23 SOCKET 1/2
7800SM-24 SOCKET 1/2
7800SM-25 SOCKET 1/2
7800SM-26 SOCKET 1/2
7800SM-27 SOCKET 1/2
7800SM-28 SOCKET 1/2
7800SM-30 SOCKET 1/2
7800SM-32 SOCKET 1/2
7809XZN-8 SOCKET 1/2
7809XZN-10 SOCKET 1/2
7809PZ-2 SOCKET 1/2
7809PZ-3 SOCKET 1/2
7809F-8 SOCKET 1/2
7809F-10 SOCKET 1/2



FF1E2207 - 25 pcs

7809TORX-T20 SOCKET 1/2
7809TORX-T25 SOCKET 1/2
7809TORX-T27 SOCKET 1/2
7809TORX-T30 SOCKET 1/2
7809TORX-T40 SOCKET 1/2
7809TORX-T45 SOCKET 1/2
7809TORX-T50 SOCKET 1/2
7809TORX-T55 SOCKET 1/2
7809TORX-T60 SOCKET 1/2
7800TORX-E8 SOCKET 1/2
7800TORX-E10 SOCKET 1/2
7800TORX-E12 SOCKET 1/2
7800TORX-E14 SOCKET 1/2
7800TORX-E16 SOCKET 1/2
7800TORX-E18 SOCKET 1/2
7800TORX-E20 SOCKET 1/2
7800TORX-E24 SOCKET 1/2
BE-9675 SCREWDRIVER SET TORX BALL 8 PCS



FF1E2208 - 12 pcs

7809M-6 SOCKET 1/2
7809M-7 SOCKET 1/2
7809M-8 SOCKET 1/2
7809M-9 SOCKET 1/2
7809M-10 SOCKET 1/2
7809M-12 SOCKET 1/2
7809M-14 SOCKET 1/2
7809M-17 SOCKET 1/2
7809M-5-180 SOCKET 1/2
7809M-6-140 SOCKET 1/2
7809M-8-120 SOCKET 1/2
7809M-10-140 SOCKET 1/2

SOCKETS

1/3 MODULE SOCKETS AND ACCESSORIES COMPOSITION

• 1/2 and Mix sockets and accessories



ERGO TOOL MANAGEMENT SYSTEM



FF1E2209 - 20 pcs

7809M-5 SOCKET 1/2
7809M-6 SOCKET 1/2
7809M-7 SOCKET 1/2
7809M-8 SOCKET 1/2
7809M-10 SOCKET 1/2
7809M-12 SOCKET 1/2
7809M-14 SOCKET 1/2
7809M-17 SOCKET 1/2
7809TORX-T27 SOCKET 1/2
7809TORX-T25 SOCKET 1/2
7809TORX-T30 SOCKET 1/2
7809TORX-T40 SOCKET 1/2
7809TORX-T45 SOCKET 1/2
7809TORX-T50 SOCKET 1/2
7809TORX-T55 SOCKET 1/2
7809TORX-T60 SOCKET 1/2
7809XZN-6 SOCKET 1/2
7809XZN-8 SOCKET 1/2
7809XZN-10 SOCKET 1/2
7809XZN-12 SOCKET 1/2



FF1E2210 - 14 pcs

7809M-5 SOCKET 1/2
7809M-6 SOCKET 1/2
7809M-7 SOCKET 1/2
7809M-8 SOCKET 1/2
7809M-10 SOCKET 1/2
7809M-12 SOCKET 1/2
7809M-14 SOCKET 1/2
7809M-17 SOCKET 1/2
7809M-19 SOCKET 1/2
BE-7606 NUT DRIVER ERGO
BWSS12P319 1/2-19 mm WHEEL IMP SOCKET
BWSS12P321 1/2-21 mm WHEEL IMP SOCKET
BWSS12P317 1/2-17 mm WHEEL IMP SOCKET
BE-7607 NUT DRIVER ERGO

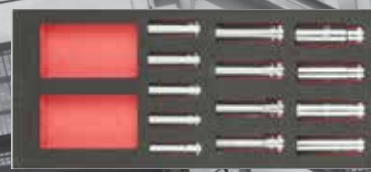

FF1E2501 - 13 pcs

A7402DM-10 SOCKET 3/8 LONG
A7402DM-11 SOCKET 3/8 LONG
A7402DM-12 SOCKET 3/8 LONG
A7402DM-13 SOCKET 3/8 LONG
A7402DM-14 SOCKET 3/8 LONG
7805SM-12 SOCKET DEEP 1/2
7805SM-13 SOCKET DEEP 1/2
7805SM-14 SOCKET DEEP 1/2
7805SM-15 SOCKET DEEP 1/2
7805SM-16 SOCKET DEEP 1/2
7805SM-17 SOCKET DEEP 1/2
7805SM-18 SOCKET DEEP 1/2
7805SM-19 SOCKET DEEP 1/2

SCREWDRIVERS

1/3 MODULE SCREWDRIVERS COMPOSITION

▪ Slotted, Phillips and Pozidriv Screwdrivers



ERGO TOOL MANAGEMENT SYSTEM



FF1E1001 - 7 pcs

BE-8030 SCREW.DR ERGO 0,6 X 8,5 X 75
BE-8040 SCREW.DR ERGO 0,8 X 4,0 X 100
BE-8242 SCREW.DR ERGO 1,0 X 5,5 X 150
BE-8252 SCREW.DR ERGO 1,2 X 6,5 X 160
BE-8610 SCREW.DR ERGO PH1 X 75
BE-8620 SCREW.DR ERGO PH2 X 100
BE-8623 SCREW.DR ERGO PH3 X 150



FF1E1002 - 7 pcs

BE-8242 SCREW.DR ERGO 1,0 X 5,5 X 150
BE-8257 SCREW.DR ERGO 1,2 X 8,0 X 175
BE-8040 SCREW.DR ERGO 0,8 X 4,0 X 100
BE-8255 SCREW.DR ERGO 1,2 X 6,5 X 150
BE-8030 SCREW.DR ERGO 0,6 X 8,5 X 75
BE-8611 SCREW.DR ERGO PH1 X 75
BE-8621 SCREW.DR ERGO PH2 X 100



FF1E1003 - 6 pcs

BE-8240 SCREW.DR ERGO 0,8 X 4,0 X 175
BE-8150 SCREW.DR ERGO 1,0 X 6,5 X 100
BE-8255 SCREW.DR ERGO 1,2 X 6,5 X 150
BE-8256 SCREW.DR ERGO 1,2 X 8,0 X 150
BE-8810 SCREW.DR ERGO PZ1 X 75
BE-8820 SCREW.DR ERGO PZ2 X 100



FF1E1004 - 8 pcs

BE-8340 SCREW.DR ERGO 0,8 X 4 X 25
BE-8350 SCREW.DR ERGO 1 X 5,5 X 25
BE-8600 SCREW.DR ERGO PH0 X 60
BE-8610 SCREW.DR ERGO PH1 X 75
BE-8800 SCREW.DR ERGO PZ0 X 60
BE-8811 SCREW.DR ERGO PZ1 X 75
BE-8820L SCREW.DR ERGO PZ2 X 200
BE-8821 SCREW.DR ERGO PZ2 X 100



FF1E1005 - 7 pcs

BE-8210 SCREW.DR ERGO 0,4 X 2,5 X 75
BE-8010 SCREW.DR ERGO 0,4 X 2,5 X 60
BE-8800 SCREW.DR ERGO PZ0 X 60
BE-8811 SCREW.DR ERGO PZ1 X 75
BE-8821 SCREW.DR ERGO PZ2 X 100
BE-8830 SCREW.DR ERGO PZ3 X 150
BE-8600 SCREW.DR ERGO PH0 X 60



FF1E1006 - 6 pcs

BE-8210 SCREW.DR ERGO 0,4 X 2,5 X 75
BE-8610 SCREW.DR ERGO PH1 X 75
BE-8820 SCREW.DR ERGO PH2 X 100
BE-8630 SCREW.DR ERGO PH3 X 150
BE-8811 SCREW.DR ERGO PZ1 X 75
BE-8820 SCREW.DR ERGO PZ2 X 100

SCREWDRIVERS

1/3 MODULE SCREWDRIVERS COMPOSITION

- Standard Torx Screwdrivers
- Insulated Slotted, PH and PZ Screwdrivers



FF1E1007 - 6 pcs

BE-8910 SCREW.DR ERGO TX 10 X 65
 BE-8915 SCREW.DR ERGO TX 15 X 70
 BE-8920 SCREW.DR ERGO TX 20 X 80
 BE-8925 SCREW.DR ERGO TX 25 X 80
 BE-8930 SCREW.DR ERGO TX 30 X 100
 BE-8940 SCREW.DR ERGO TX 40 X 130



FF1E1008 - 6 pcs

BE-7910 SCREW.DR ERGO BTX 10 X 65
 BE-7915 SCREW.DR ERGO BTX 15 X 70
 BE-7920 SCREW.DR ERGO BTX 20 X 80
 BE-7925 SCREW.DR ERGO BTX 25 X 80
 BE-7930 SCREW.DR ERGO BTX 30 X 100
 BE-7940 SCREW.DR ERGO BTX 40 X 130
 BE-8621 SCREW.DR ERGO PH2 X 100



FF1E1009 - 6 pcs

BE-8908 SCREW.DR ERGO TX 8 X 60
 BE-8910 SCREW.DR ERGO TX 10 X 65
 BE-8915 SCREW.DR ERGO TX 15 X 70
 BE-8920 SCREW.DR ERGO TX 20 X 80
 BE-8925 SCREW.DR ERGO TX 25 X 80
 BE-8930 SCREW.DR ERGO TX 30 X 100



FF1E1010 - 6 pcs

BE-8010S SCREW.DR ERGO IEC 0,4 X 2,5 X 75
 BE-8230S SCREW.DR ERGO IEC 0,6 X 3,5 X 100
 BE-8050S SCREW.DR ERGO IEC 1,0 X 5,5 X 125
 BE-8255S SCREW.DR ERGO IEC 1,2 X 6,5 X 150
 BE-8610S SCREW.DR ERGO IEC PH1 X 75
 BE-8620S SCREW.DR ERGO IEC PH2 X 100

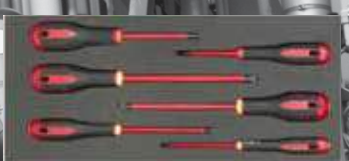

FF1E1011 - 6 pcs

BE-8040S SCREW.DR ERGO IEC 0,8 X 4,0 X 100
 BE-8050S SCREW.DR ERGO IEC 1,0 X 5,5 X 125
 BE-8255S SCREW.DR ERGO IEC 1,2 X 6,5 X 150
 BE-8065S SCREW.DR ERGO IEC 1,2 X 8,0 X 175
 BE-8610S SCREW.DR ERGO IEC PH1 X 75
 BE-8620S SCREW.DR ERGO IEC PH2 X 100

PLIERS

1/3 MODULE PLIERS COMPOSITION

- Mix pliers
- Circlip Pliers

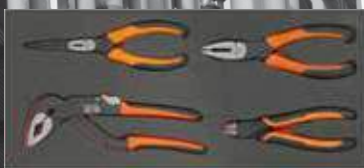

FF1E4001 - 4 pcs

- 2628 G-180IP COMB PLIER 180 mm
- 8231 IP SLIP JOINT PLIER
- 2430 G-200 IP SNIPE NOSE CUTTING 200 mm
- 2101G-160IP SIDE CUTTER 160 mm



FF1E4002 - 4 pcs

- 2900-180 CIRCLIP PLIER 180 mm
- 2890-180 CIRCLIP PLIER 180 mm
- 2990-180 CIRCLIP PLIER 180 mm
- 2800-180 CIRCLIP PLIER 180 mm

WRENCHES

1/3 MODULE WRENCHES COMPOSITION

- Double Open end metric and Imperial Wrenches
- Ratcheting Wrenches



FF1E3001 - 9 pcs

- 6M-6-7 OPEN END WRENCH
- 6M-8-9 OPEN END WRENCH
- 6M-10-11 OPEN END WRENCH
- 6M-12-13 OPEN END WRENCH
- 6M-14-15 OPEN END WRENCH
- 6M-16-17 OPEN END WRENCH
- 6M-18-19 OPEN END WRENCH
- 6M-21-23 OPEN END WRENCH
- 6M-22-24 OPEN END WRENCH



FF1E3002 - 3 pcs

- 6M-25-28 OPEN END WRENCH
- 6M-27-29 OPEN END WRENCH
- 6M-30-32 OPEN END WRENCH



FF1E3003 - 9 pcs

- 6Z-1/2-9/16 OPEN END WRENCH
- 6Z-15/16-1 OPEN END WRENCH
- 6Z-5/16-11/32 OPEN END WRENCH
- 6Z-5/8-3/4 OPEN END WRENCH
- 6Z-3/8-7/16 OPEN END WRENCH
- 6Z-25/32-13/16 OPEN END WRENCH
- 6Z-19/32-11/16 OPEN END WRENCH
- 6Z-1/4-5/16 OPEN END WRENCH
- 6Z-3/4-7/8 OPEN END WRENCH



FF1E3004 - 10 pcs

- 1RM-8 RATCHET WRENCH
- 1RM-9 RATCHET WRENCH
- 1RM-10 RATCHET WRENCH
- 1RM-11 RATCHET WRENCH
- 1RM-12 RATCHET WRENCH
- 1RM-13 RATCHET WRENCH
- 1RM-14 RATCHET WRENCH
- 1RM-15 RATCHET WRENCH
- 1RM-16 RATCHET WRENCH
- 1RM-17 RATCHET WRENCH



FF1E3005 - 40 pcs

- 41RM-8 RATCHET WRENCH LOCKING FLEX HEAD
- 41RM-10 RATCHET WRENCH LOCKING FLEX HEAD
- 41RM-12 RATCHET WRENCH LOCKING FLEX HEAD
- 41RM-13 RATCHET WRENCH LOCKING FLEX HEAD
- 41RM-14 RATCHET WRENCH LOCKING FLEX HEAD
- 41RM-17 RATCHET WRENCH LOCKING FLEX HEAD
- 41RM-19 RATCHET WRENCH LOCKING FLEX HEAD
- 8166-1/2 UNIVERSAL JOINT
- 6966 UNIVERSAL JOINT
- 59S/31-1 BITS SET 31PCS PH, PZ, T, HEX, SL

WRENCHES

1/3 MODULE WRENCHES COMPOSITION

- Double Ring End Wrenches
- Ratcheting Wrenches
- Tubular Box Wrenches



FF1E3006 - 8 pcs

1320RM-6-7 RATCHET WRENCH DOUBLE FLAT
 1320RM-8-9 RATCHET WRENCH DOUBLE FLAT
 1320RM-10-11 RATCHET WRENCH DOUBLE FLAT
 1320RM-12-13 RATCHET WRENCH DOUBLE FLAT
 1320RM-14-15 RATCHET WRENCH DOUBLE FLAT
 1320RM-16-17 RATCHET WRENCH DOUBLE FLAT
 1320RM-18-19 RATCHET WRENCH DOUBLE FLAT
 1320RM-22-24 RATCHET WRENCH DOUBLE FLAT



FF1E3007 - 7 pcs

2M-6-7 RING WRENCH
 2M-8-9 RING WRENCH
 2M-10-11 RING WRENCH
 2M-12-13 RING WRENCH
 2M-14-15 RING WRENCH
 2M-16-17 RING WRENCH
 2M-18-19 RING WRENCH

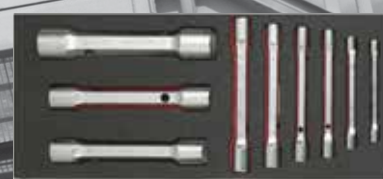

FF1E3008 - 9 pcs

27M-8-9 TUBULAR BOX SPANNER 8-9 mm
 27M-10-11 TUBULAR BOX SPANNER 10-11 mm
 27M-12-13 TUBULAR BOX SPANNER 12-13 mm
 27M-14-15 TUBULAR BOX SPANNER 14-15 mm
 27M-16-17 TUBULAR BOX SPANNER 16-17 mm
 27M-18-19 TUBULAR BOX SPANNER 18-19 mm
 27M-20-22 TUBULAR BOX SPANNER 20-22 mm
 27M-21-23 TUBULAR BOX SPANNER 21-23 mm
 27M-24-27 TUBULAR BOX SPANNER 24-27 mm



MIX AND WRENCHES

2/3 MODULE MIX AND WRENCHES COMPOSITION

- Double Ring end Wrenches
- Flex Head Wrenches
- Open Ring Wrenches



FF1F5001 - 10 pcs

- 1-100-08-1-2 8" HAND, WITH HANDLE, CUT 1
- 1-160-08-1-2 8" SQUARE, WITH HANDLE, CUT 1
- 1-170-08-1-2 6" 3 SQUARE, WITH HANDLE, CUT 1
- 1-210-08-1-2 8" 1/2 ROUND, WITH HANDLE, CUT 1
- 1-230-08-1-2 8" ROUND, WITH HANDLE, CUT 1
- 2430 G-200 IP SNIPE NOSE CUTTING 200 mm
- 2628G-200IP COMB PLIER 200 mm
- 7224 SLIP JOINT PLIER 250 mm
- 2101G-160IP SIDE CUTTER 160 mm
- MTB-3-16 3M TAPE MEASURE 16 mm



FF1F3007 - 10 pcs

- 2M-6-7 RING WRENCH
- 2M-8-9 RING WRENCH
- 2M-10-11 RING WRENCH
- 2M-12-13 RING WRENCH
- 2M-14-15 RING WRENCH
- 2M-16-18 RING WRENCH
- 2M-17-19 RING WRENCH
- 2M-21-23 RING WRENCH
- 2M-24-27 RING WRENCH
- 2M-30-32 RING WRENCH



FF1F3008 - 9 pcs

- 4040M-6-7 FLEX HEAD WRENCH
- 4040M-8-9 FLEX HEAD WRENCH
- 4040M-10-11 FLEX HEAD WRENCH
- 4040M-12-13 FLEX HEAD WRENCH
- 4040M-14-15 FLEX HEAD WRENCH
- 4040M-16-17 FLEX HEAD WRENCH
- 4040M-18-19 FLEX HEAD WRENCH
- 4040M-20-22 FLEX HEAD WRENCH
- 4040M-21-23 FLEX HEAD WRENCH



FF1F3009 - 8 pcs

- 1949M-8-9 OPEN RING WRENCH
- 1949M-10-11 OPEN RING WRENCH
- 1949M-12-13 OPEN RING WRENCH
- 1949M-14-15 OPEN RING WRENCH
- 1949M-17-19 OPEN RING WRENCH
- 1949M-19-22 OPEN RING WRENCH
- 1949M-24-27 OPEN RING WRENCH
- 1949M-30-32 OPEN RING WRENCH

PLIERS

2/3 MODULE PLIERS COMPOSITION

- Pliers Mix Including:
 - Side Cutting Pliers
 - Slip Joint Pliers
 - Circlip Pliers
 - Snipe Nose Pliers
 - Combination Pliers



FF1F4001 - 8 pcs

- 2430 G-160 IP SNIPE NOSE CUTTING 160 mm
- 2421 G-180 IP FLAT NOSE PL 180 mm
- 2101G-160IP SIDE CUTTER 160 mm
- 2628 G-200 COMBINATION PLIER ERGO 200 mm
- 8224 IP SLIP JOINT PLIER
- 9029 ADJUSTABLE WRENCH
- 2951-140 CURVED JAWS CLAMP 140 mm
- 2951-300 GRIP WITH WIRE CUTTER 300 mm



FF1F4002 - 8 pcs

- 2928-160 CIRCLIP PLIER 160 mm
- 2951-250 GRIP WITH WIRE CUTTER 250 mm
- SC127 ELECTRICIAN'S SCISSORS 5" 130 mm
- 2101G-160IP SIDE CUTTER 160 mm
- 8224 IP SLIP JOINT PLIER 260 mm
- 2430 G-160 IP SNIPE NOSE CUTTING 160 mm
- 2339 DIP FENCING PLIER 2339 DIP
- 2628 G-180IP COMB PLIER 180 mm

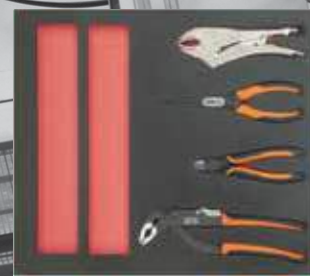

FF1F4003 - 4 pcs

- 2101G-160IP SIDE CUTTER 160 mm
- 8224 IP SLIP JOINT PLIER 260 mm
- 2951-180 GRIP WITH WIRE CUTTER 180 mm
- 2430 G-200 IP SNIPE NOSE CUTTING 200 mm

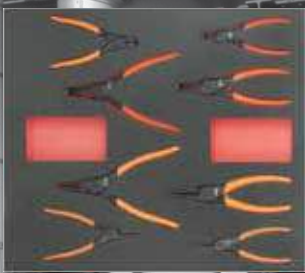

FF1F4004 - 8 pcs

- 2800-140 CIRCLIP PLIER 130 mm
- 2800-180 CIRCLIP PLIER 180 mm
- 2890-140 CIRCLIP PLIER 140 mm
- 2890-180 CIRCLIP PLIER 180 mm
- 2900-140 EXT. RING PLIER 140 mm
- 2900-180 CIRCLIP PLIER 180 mm
- 2990-140 CIRCLIP PLIER 140 mm
- 2990-180 CIRCLIP PLIER 180 mm



FF1F4005 - 5 pcs

- 2101S-160 SIDE CUTTER 160 mm
- 2430 S-200 LONG NOSE PLIER 200 mm
- 2427 S-200 LONG NOSE PLIER 200 mm
- 8224 IP SLIP JOINT PLIER 250 mm
- 2628 S-180 COMB PLIER 180 mm

SCREWDRIVERS

2/3 MODULE SCREWDRIVERS COMPOSITION

- Slotted Screwdrivers
- PH Screwdrivers



ERGO TOOL MANAGEMENT SYSTEM



FF1F1001 - 8 pcs

BE-8210 SCREW.DR ERGO 0,4 X 2,5 X 75
 BE-8030 SCREW.DR ERGO 0,6 X 3,5 X 75
 BE-8040 SCREW.DR ERGO 0,8 X 4,0 X 100
 BE-8242 SCREW.DR ERGO 1,0 X 5,5 X 150
 BE-8250L SCREW.DR ERGO 1 X 5,5 X 200
 BE-8255 SCREW.DR ERGO 1,2 X 6,5 X 150
 BE-8257 SCREW.DR ERGO 1,2 X 6,0 X 175



FF1F1002 - 11 pcs

BE-8020 SCREW.DR ERGO 0,5 X 3,0 X 60
 BE-8330 SCREW.DR ERGO 0,6 X 3,5 X 25
 BE-8040 SCREW.DR ERGO 0,8 X 4,0 X 100
 BE-8242 SCREW.DR ERGO 1,0 X 5,5 X 150
 BE-8252 SCREW.DR ERGO 1,2 X 6,5 X 150
 BE-8256 SCREW.DR ERGO 1,2 X 8,0 X 150
 BE-8258 SCREW.DR ERGO 1,5 X 10,0 X 200
 BE-8610 SCREW.DR ERGO PH1 X 75
 BE-8602 SCREW.DR ERGO PH2 X 25
 BE-8620 SCREW.DR ERGO PH2 X 100
 BE-8623 SCREW.DR ERGO PH3 X 150



FF1F1003 - 11 pcs

BE-8030 SCREW.DR ERGO 0,6 X 3,5 X 75
 BE-8242 SCREW.DR ERGO 1,0 X 5,5 X 150
 BE-8155 SCREW.DR ERGO 1,2 X 6,5 X 125
 BE-8252 SCREW.DR ERGO 1,2 X 6,5 X 150
 BE-8870 SCREW.DR ERGO 1,8 X 10,0 X 175
 BE-8600 SCREW.DR ERGO PH0 X 50
 BE-8610 SCREW.DR ERGO PH1 X 75
 BE-8620 SCREW.DR ERGO PH2 X 100
 BE-8623 SCREW.DR ERGO PH3 X 150
 BE-8624 SCREW.DR ERGO PH4 X 200
 808050TS STUBBY HANDLE RATCHETING SCRE

SCREWDRIVERS

2/3 MODULE SCREWDRIVERS COMPOSITION

- Torx Screwdrivers
- Insulated Slotted and PH Screwdrivers
- T Handle



FF1F1004 - 10 pc

BE-8904 SCREW.DR ERGO TX 4 X 75
 BE-8907 SCREW.DR ERGO TX 7 X 65
 BE-8908 SCREW.DR ERGO TX 8 X 60
 BE-7910 SCREW.DR ERGO BTX 10 X 65
 BE-7915 SCREW.DR ERGO BTX 15 X 70
 BE-7920 SCREW.DR ERGO BTX 20 X 80
 BE-7925 SCREW.DR ERGO BTX 25 X 80
 BE-7927 SCREW.DR ERGO BTX 27 X 100
 BE-7930 SCREW.DR ERGO BTX 30 X 100
 BE-7940 SCREW.DR ERGO BTX 40 X 130



FF1F1005 - 12 pcs

BE-8908 SCREW.DR ERGO TX 8 X 60
 BE-8909 SCREW.DR ERGO TX 9 X 60
 BE-8910 SCREW.DR ERGO TX 10 X 65
 BE-8915 SCREW.DR ERGO TX 15 X 70
 BE-8920 SCREW.DR ERGO TX 20 X 80
 BE-8925 SCREW.DR ERGO TX 25 X 80
 BE-8927 SCREW.DR ERGO TX 27 X 100
 BE-8930 SCREW.DR ERGO TX 30 X 100
 59S/31-3 BITS SET 31PCS PH,PZ,TR
 K6650-1/4 ADAPTOR 1/4" 50MM 1/4" W/PIN
 808050S STUBBY RATCHETING SCREWDRIVER
 808050 RATCHETING BIT SCREWDRIVER



FF1F1006 - 8 pcs

BE-8230S SCREW.DR ERGO IEC 0.6 X 3.5 X 100
 BE-8040S SCREW.DR ERGO IEC 0.8 X 4.0 X 100
 BE-8050S SCREW.DR ERGO IEC 1.0 X 5.5 X 125
 BE-8255S SCREW.DR ERGO IEC 1.2 X 6.5 X 150
 BE-8810S SCREW.DR ERGO IEC P21 X 75
 BE-8820S SCREW.DR ERGO IEC P22 X 100
 BE-8610S SCREW.DR ERGO IEC PH1 X 75
 BE-8620S SCREW.DR ERGO IEC PH2 X 100



FF1F1007 - 7 pcs

901T-010-100 TORX T-HANDLE 10 X 100
 901T-015-150 TORX T-HANDLE 15 X 150
 901T-020-150 TORX T-HANDLE 20 X 150
 901T-025-150 TORX T-HANDLE 25 X 150
 901T-027-150 TORX T-HANDLE 27 X 150
 901T-030-200 TORX T-HANDLE 30 X 200
 901T-040-200 TORX T-HANDLE 40 X 200

SOCKETS

2/3 MODULE SOCKETS AND ACCESSORIES COMPOSITION

- 1/4 and 3/8 sockets and accessories



FF1F2001 - 44 pcs

A6800DM-4 SOCKET 1/4, LONG
 A6800DM-5 SOCKET 1/4, LONG
 A6800DM-5.5 SOCKET 1/4, LONG
 A6800DM-6 SOCKET 1/4, LONG
 A6800DM-7 SOCKET 1/4, LONG
 A6800DM-8 SOCKET 1/4, LONG
 A6800DM-9 SOCKET 1/4, LONG
 A6800DM-10 SOCKET 1/4, LONG
 A6800DM-11 SOCKET 1/4, LONG
 A6800DM-12 SOCKET 1/4, LONG
 A6800DM-13 SOCKET 1/4, LONG
 6700SM-5 SOCKET 1/4
 6700SM-5.5 SOCKET 1/4
 6700SM-6 SOCKET 1/4
 6700SM-7 SOCKET 1/4
 6700SM-8 SOCKET 1/4
 6700SM-9 SOCKET 1/4
 6700SM-10 SOCKET 1/4
 6700SM-11 SOCKET 1/4
 6700SM-12 SOCKET 1/4
 6700SM-13 SOCKET 1/4
 6700SM-14 SOCKET 1/4

6709PH-1 SOCKET 1/4
 6709PH-2 SOCKET 1/4
 6709PH-3 SOCKET 1/4
 6709PZ-1 SOCKET 1/4
 6709PZ-2 SOCKET 1/4
 6709M-3 SOCKET 1/4
 6709M-4 SOCKET 1/4
 6709M-5 SOCKET 1/4
 6709M-6 SOCKET 1/4
 6709M-8 SOCKET 1/4
 6709F-4.5 SOCKET 1/4
 6709F-5.5 SOCKET 1/4
 6709F-8 SOCKET 1/4
 BE-9778 SCREWDRIVER SET HEX INCK. 9 PCS
 6950SL RATCHET 1/4, SLIM HEAD 72T
 7765 ADAPTOR 1/4
 6954 T-HANDLE 1/4
 6962 EXTENSION 1/4
 6966 UNIVERSAL JOINT 1/4
 6972H POWER SOCKET HOLDER 1/4
 6956 NUT DRIVER
 1997M-12 SCREWDR OFFSET HEX 12



FF1F2101 - 36 pcs

7400SM-7 SOCKET 3/8
 7400SM-8 SOCKET 3/8
 7400SM-9 SOCKET 3/8
 7400SM-10 SOCKET 3/8
 7400SM-11 SOCKET 3/8
 7400SM-12 SOCKET 3/8
 7400SM-13 SOCKET 3/8
 7400SM-14 SOCKET 3/8
 7400SM-15 SOCKET 3/8
 7400SM-16 SOCKET 3/8
 7400SM-17 SOCKET 3/8
 7400SM-18 SOCKET 3/8
 7400SM-19 SOCKET 3/8
 7400SM-20 SOCKET 3/8
 7400SM-21 SOCKET 3/8
 7400SM-22 SOCKET 3/8
 7409M-4 SOCKET DRIVER 3/8 HEX
 7409M-6 SOCKET DRIVER 3/8 HEX

SOCKETS

2/3 MODULE SOCKETS AND ACCESSORIES COMPOSITION

• 3/8 and 1/2 sockets and accessories



ERGO TOOL MANAGEMENT SYSTEM



FF1F2101 - 36 pcs

740SM-8 SOCKET DRIVER 3/8 HEX
 7409M-10 SOCKET DRIVER 3/8 HEX
 A7402DM-13 SOCKET 3/8, LONG
 A7402DM-11 SOCKET 3/8, LONG
 A7402DM-10 SOCKET 3/8, LONG
 A7402DM-12 SOCKET 3/8, LONG
 A7410DZ-5/16 SWIVEL SOCKET 3/8, LONG
 A7410DZ-7/16 SWIVEL SOCKET 3/8, LONG
 A7410DZ-9/16 SWIVEL SOCKETS 3/8, LONG
 A7410DZ-3/8 SWIVEL SOCKET 3/8, LONG
 A7410DZ-5/8 SWIVEL SOCKET 3/8, LONG
 7750SL RATCHET 3/8, SLIM HEAD 72T
 7762 EXTENSION 3/8
 8164-1/2 ADAPTOR 3/8
 7754 T-HANDLE 3/8
 7766 UNIVERSAL JOINT 3/8
 7764 ADAPTOR 3/8
 7757 NUT DRIVER 3/8



FF1F2201 - 35 pcs

7800SM-10 SOCKET 1/2
 7800SM-12 SOCKET 1/2
 7800SM-13 SOCKET 1/2
 7800SM-17 SOCKET 1/2
 7800SM-18 SOCKET 1/2
 7800SM-19 SOCKET 1/2
 7800SM-20 SOCKET 1/2
 7800SM-21 SOCKET 1/2
 7800SM-22 SOCKET 1/2
 7800SM-24 SOCKET 1/2
 7800SM-27 SOCKET 1/2
 7800SM-30 SOCKET 1/2
 7800SM-32 SOCKET 1/2
 7800DM-10 SOCKET 1/2
 7800DM-11 SOCKET 1/2
 7800DM-12 SOCKET 1/2
 7800DM-13 SOCKET 1/2

7800DM-14 SOCKET 1/2
 7800DM-15 SOCKET 1/2
 7800DM-16 SOCKET 1/2
 7800DM-17 SOCKET 1/2
 7800DM-18 SOCKET 1/2
 7800DM-19 SOCKET 1/2
 7809M-5 SOCKET 1/2
 7809M-6 SOCKET 1/2
 7809M-7 SOCKET 1/2
 7809M-8 SOCKET 1/2
 7809M-10 SOCKET 1/2
 7809M-12 SOCKET 1/2
 8150SL RATCHET 1/2, SLIM HEAD 72T
 8160-1/2 EXTENSION 1/2
 8162-1/2 EXTENSION 1/2
 8166-1/2 UNIVERSAL JOINT 1/2
 8154-1/2 T-HANDLE 1/2
 8165-1/2 ADAPTOR 1/2

WRENCHES

2/3 MODULE WRENCHES COMPOSITION

- Double Open End Wrenches
- Combination Wrenches



FF1F3001 - 11 pcs

- 6M-6-7 OPEN END WRENCH
- 6M-8-9 OPEN END WRENCH
- 6M-10-11 OPEN END WRENCH
- 6M-12-13 OPEN END WRENCH
- 6M-14-15 OPEN END WRENCH
- 6M-16-18 OPEN END WRENCH
- 6M-17-19 OPEN END WRENCH
- 6M-20-22 OPEN END WRENCH
- 6M-21-23 OPEN END WRENCH
- 6M-24-27 OPEN END WRENCH
- 6M-30-32 OPEN END WRENCH



FF1F3002 - 18 pcs

- 111M-6 COMBINATION WRENCH
- 111M-7 COMBINATION WRENCH
- 111M-8 COMBINATION WRENCH
- 111M-9 COMBINATION WRENCH
- 111M-10 COMBINATION WRENCH
- 111M-11 COMBINATION WRENCH
- 111M-12 COMBINATION WRENCH
- 111M-13 COMBINATION WRENCH
- 111M-14 COMBINATION WRENCH
- 111M-15 COMBINATION WRENCH
- 111M-16 COMBINATION WRENCH
- 111M-17 COMBINATION WRENCH
- 111M-18 COMBINATION WRENCH
- 111M-19 COMBINATION WRENCH
- 111M-21 COMBINATION WRENCH
- 111M-22 COMBINATION WRENCH
- 111M-24 COMBINATION WRENCH
- 111M-27 COMBINATION WRENCH



FF1F3003 - 30 pcs

- 111M-6 COMBINATION WRENCH
- 111M-7 COMBINATION WRENCH
- 111M-8 COMBINATION WRENCH
- 111M-9 COMBINATION WRENCH
- 111M-10 COMBINATION WRENCH
- 111M-11 COMBINATION WRENCH
- 111M-12 COMBINATION WRENCH
- 111M-13 COMBINATION WRENCH
- 111M-14 COMBINATION WRENCH
- 111M-15 COMBINATION WRENCH
- 111M-16 COMBINATION WRENCH
- 111M-17 COMBINATION WRENCH
- 111M-18 COMBINATION WRENCH
- 111M-19 COMBINATION WRENCH
- 111M-20 COMBINATION WRENCH
- 111M-21 COMBINATION WRENCH
- 111M-22 COMBINATION WRENCH
- 1320SRM-14-19 S RATCHET WR DOUBLE FLAT
- 1RMA-19-1/4-SQ 19MM RATCHETING WR ADAPTOR
- 1RMA-19-1/2-SQ2 19MM RATCHETING WR ADAPTOR
- 1RMA-13-10-BIT BIT ADAPTOR 10 mm
- BE-9778 SCREWDRIVER SET HEX NICK. 9 PCS

WRENCHES

2/3 MODULE WRENCHES COMPOSITION

- Ratcheting Wrenches
- Combination Wrenches



ERGO TOOL MANAGEMENT SYSTEM



FF1F3004 - 13 pcs

- 111Z-3/8 COMBINATION WRENCH
- 111Z-11/16 COMBINATION WRENCH
- 111Z-1 COMBINATION WRENCH
- 111Z-1/2 COMBINATION WRENCH
- 111Z-13/16 COMBINATION WRENCH
- 111Z-5/16 COMBINATION WRENCH
- 111Z-5/8 COMBINATION WRENCH
- 111Z-15/16 COMBINATION WRENCH
- 111Z-7/16 COMBINATION WRENCH
- 111Z-3/4 COMBINATION WRENCH
- 111Z-1/4 COMBINATION WRENCH
- 111Z-9/16 COMBINATION WRENCH
- 111Z-7/8 COMBINATION WRENCH



FF1F3005 - 15 pcs

- 1RM-8 RATCHET WRENCH
- 1RM-10 RATCHET WRENCH
- 1RM-12 RATCHET WRENCH
- 1RM-13 RATCHET WRENCH
- 1RM-14 RATCHET WRENCH
- 1RM-15 RATCHET WRENCH
- 1RM-16 RATCHET WRENCH
- 1RM-17 RATCHET WRENCH
- 1RM-18 RATCHET WRENCH
- 1RM-19 RATCHET WRENCH
- 1RM-21 RATCHET WRENCH
- 1RM-22 RATCHET WRENCH
- 1RMA-13-10-BIT ADAPTOR 10 mm
- 1RMA-19-1/2-SQ2 19 mm RATCHETING WR ADAPTOR
- 1RMA-19-1/4-SQ 19 mm RATCHETING WR ADAPTOR



FF1F3006 - 7 pcs

- 1RM-19 RATCHET WRENCH
- 1RM-21 RATCHET WRENCH
- 1RM-22 RATCHET WRENCH
- 1RM-24 RATCHET WRENCH
- 1RM-27 RATCHET WRENCH
- 1RM-30 RATCHET WRENCH

MIX

3/3 MODULE MIX COMPOSITION



ERGO TOOL MANAGEMENT SYSTEM

**FF1A01 - 77 pcs**

A6800DM SOCKET 1/4", LONG
4, 5, 6, 7, 8, 9, 10, 11, 12, 13

6700SM SOCKET 1/4", SHORT
4, 4.5, 5, 5.5, 6, 7, 8, 9, 10, 11, 12, 13

6972H BIT HOLDER 1/4"

6950SL REVERSIBLE RATCHET 1/4", SLIMHEAD

6954 T-HANDLE 1/4"

6956 SPINNER HANDLE 1/4"

6960 EXTENSION BAR 1/4" 50 mm

6961 EXTENSION BAR 1/4" 100 mm

6966 UNIVERSAL JOINT 1/4"

7805ZZ-21 SPARK PLUG SOCKET 1/2"

7800SM SOCKET 1/2", SHORT SERIES
10, 11, 12, 13, 14, 15, 16, 17, 18, 19, 22, 24, 27, 30, 32

8150SL REVERSIBLE RATCHET 1/2", SLIMHEAD

8154-1/2 SLIDING T-HANDLE 1/2"

8159-1/2 EXTENSION BAR 1/2" 75mm

8162-1/2 EXTENSION BAR 1/2" 250 mm

8166-1/2 UNIVERSAL JOINT 1/2"

7807H BIT HOLDER 1/2"

59S/22-T 22 PCS RUBBER BIT HOLDER
PH, PZ, TORX®, SL

813 SCREWDRIVERS SLOTTED
4x100, 5.5x150 mm

815 SCREWDRIVERS PHILLIPS
PH1x100; PH2x125

**FF1A02 - 19 pcs**

6M OPEN END WRENCH
6x7, 8x9, 10x11, 12x13, 14x15, 16x17, 18x19, 20x22 mm

111M COMBINATION WRENCH
6, 7, 8, 10, 12, 13, 14, 17, 19, 22

808050L RATCHETING BIT SCREWDRIVER WITH LEDS

**FF1A03 - 18 pcs**

BE-9770 BLACK HEX KEYS SET, LONG BALL END, 9 PCS
1.5, 2, 2.5, 3, 4, 5, 6, 8, 10

21716-160 SIDE CUTTER 160 mm

26786-160 COMBINATION PLIER 160 mm

29716-250 SLIP JOINT PLIER 250 mm

3734N DRIFT PUNCH 4x150, 6x150

481-400 DIN HAMMER

306 HACKSAW FRAME AND SANDREX® BI-METAL BLADE

1-100-08-2-2 8" FLAT FILE, WITH HANDLE, SECOND

MTG-5-19 5m TAPE MEASURE 19mm

MIX

3/3 MODULE MIX COMPOSITION



ERGO TOOL MANAGEMENT SYSTEM

**FF1A04 - 30 pcs****S4RM** FOUR SIZES RATCHETING WRENCH

8x11, 12x15, 16x19

111M COMBINATION WRENCH

6, 7, 8, 9, 10, 11, 12, 13, 14, 15, 16, 17, 18, 19, 21, 22, 24, 27, 30, 32

6M OPEN-END WRENCH

6x7, 8x9, 10x11, 12x13, 14x15, 17x19

9071C ADJUSTABLE WRENCH CHROMED 8" ERGO™**FF1A07 - 15 pcs****3734N** DRIFT PUNCH 3, 5, 6**3735N-4-120** CENTRE PUNCH**3740-175** FLAT CHISEL**SQZ150003** SQUEEZE KNIFE**1-100-08-2-2** 8" FLAT FILE

WITH HANDLE, SECOND

1-210-08-2-2 8" HALF ROUND FILE,

WITH HANDLE, SECOND

1-230-08-2-2 8" ROUND FILE, WITH HANDLE, SECOND**2744** MULTIPURPOSE SNIP 190 mm**317** HACKSAW FRAME AND SANDEFLEX® BI-METAL BLADE**3625W-35** NYLON TIP HAMMER 35 mm**3745-150** CAPE CHISEL 150 mm**481-400** DIN-HAMMER**782-U** UTILITY WIRE BRUSH**FF1A05 - 104 pcs****BE-9678** BLACK KEYS SET, LONG BALL END 9 PCS

1.5, 2, 2.5, 3, 4, 5, 6, 8, 10

SBS60 SOCKET 1/4"

4, 4.5, 5, 5.5, 6, 7, 8, 9, 10, 11, 12, 13, 14

SBS61 RATCHET 1/4"**SBS63** EXTENSION BARS 1/4" 50, 100, 150mm**SBS64** T-HANDLE 1/4"**SBS65** UNIVERSAL JOINT 1/4"**SBS67** BREAKER BAR 1/4"**SBS69** ADAPTOR 1/4"-3/8"**6956** SPINNER HANDLE 1/4"**6972H** BIT HOLDER 1/4"**SBS80** SOCKET 1/2"

10, 11, 12, 13, 14, 15, 16, 17, 18, 19, 21, 22, 24, 27, 30, 32

8150SL REVERSIBLE RATCHET 1/2" SLIMHEAD**8160-W** EXTENSION BAR 1/2"**8159-1/2** EXTENSION BAR 1/2" 75mm**8162-1/2** EXTENSION BAR 1/2" 50mm**8166-1/2** UNIVERSAL JOINT 1/2"**8154-1/2** SLIDING T-HANDLE 1/2"**SBS88** ADAPTOR 1/2"-3/8"**7809M** SOCKET DRIVER 1/2", HEX

5, 6, 7, 8, 10, 12, 14, 17, 19

7809TORX SOCKET DRIVER 1/2" TORX®

T20, T25, T27, T30, T40, T45, T50, T65, T80

808050 RATCHETING BIT SCREWDRIVER**59S/31-1** BITS SET

31 PCS: PH, PZ, TORX®, HEX, SL

**FF1A06 - 23 pcs****BE-8020L / BE-8040** SCREWDRIVERS ERGO™ SLOTTED

0.5X8X75, 0.8X4, 0X100

BE-8150 / BE-8255 / BE-8256 SCREWDRIVERS ERGO™

SLOTTED

1, 0X5, 5X100, 1, 2X6, 5X150, 1, 6X8, 0X150

BE-8350 SCREWDRIVER ERGO™ SLOTTED, STUBBY

1X5, 5X25

BE-8601 SCREWDRIVER ERGO™ PHILLIPS, STUBBY

PH1X25

BE-8610 / BE-8620 SCREWDRIVERS ERGO™ PHILLIPS

PH1X75, PH2X100

BE-8910 / BE-8930 SCREWDRIVERS ERGO™ TORX®

T10X75, T15X100, T20X100, T25X125, T27X125, T30X150

MTB-3-16 TAPE MEASURE

3 m

2101 G-160IP SIDE CUTTER ERGO™**2427 G-200IP** SNIPE NOSE PLIER, BENT ERGO™**2628 G-160IP** COMBINATION PLIER ERGO™**8224 IP** SLIP JOINT PLIER ERGO™**2951-180** GRIP WITH WIRE CUTTER**5515T-52** TELESCOPIC SWIVEL HEAD MIRROR

Ø 50 mm

2535L MAGNETIC PICK-UP WITH LIGHT

MIX

3/3 MODULE MIX COMPOSITION



ERGO TOOL MANAGEMENT SYSTEM



FF1A08 - 138 pcs

6700SM SOCKET 1/4", SHORT

5.5, 6, 7, 8, 9, 10, 11, 12, 13

A6800DM SOCKET 1/4", LONG

5.5, 6, 7, 8, 9, 10, 11, 12, 13

6709M SOCKET DRIVER 1/4", HEX

3, 4, 5, 6, 8

6709PH SOCKET DRIVER 1/4", PH

1, 2, 3

6709TORX SOCKET DRIVER 1/4", TORX®

T8, T9, T10, T15, T20, T25, T27, T30, T40

6950SL REVERSIBLE RATCHET 1/4", SLIMHEAD

6954 T-HANDLE 1/4"

6956 SPINNER HANDLE 1/4"

6958 BREAKER BAR 1/4"

6960 / 6961 / 6962 / 6962L EXTENSION BARS 1/4"

60, 100, 150, 355 mm

6966 UNIVERSAL JOINT 1/4"

6972H BIT HOLDER 1/4"

7764 ADAPTOR F 3/8" - M 1/4"

7400SM SOCKET 3/8", SHORT SERIES

6, 7, 8, 9, 10, 11, 12, 13, 14, 15, 16, 17, 18, 19, 22

A7402DM SOCKET 3/8", LONG

10, 11, 12, 13, 14, 15, 16, 17, 18, 19

7409M SOCKET DRIVER 3/8" HEX

3, 4, 5, 6, 7, 8, 10

7409TORX SOCKET DRIVER 3/8", TORX®

T25, T27, T30, T40, T45, T50

7750SL RATCHET 3/8" SLIMHEAD

7754 T-HANDLE 3/8"

7758 BREAKER BAR 3/8"

7760 / 7761 / 7762

EXTENSION BARS 3/8"

75, 125, 250 mm

7766 UNIVERSAL JOINT 3/8"

7765 ADAPTOR F 1/4" - M 3/8"

8164-1/2 ADAPTOR F 3/8" - M 1/2"

7407H SOCKET HOLDER 3/8"

1/4" - 3/8"

7800SM SOCKET 1/2" SHORT 10, 11, 12, 13, 14, 15, 16, 17,

18, 19, 21, 22, 24, 27, 30, 32

7809M SOCKET DRIVER 1/2", HEX

5, 6, 7, 8, 10, 12, 14, 17, 19

7809TORX SOCKET DRIVER 1/2", TORX®

T20, T25, T27, T30, T40, T45, T50, T65, T60

8154-1/2 T-HANDLE 1/2"

8150SL RATCHET 1/2", SEMIHEAD

8160-1/2 EXTENSION BAR 1/2"

125 mm

8162-1/2 EXTENSION BAR 1/2"

250 mm

8166-1/2 UNIVERSAL JOINT 1/2"

8165-1/2 ADAPTOR F 1/2" - M 3/8"

8964 ADAPTOR F 1/2" - M 3/4"

7807H SOCKET HOLDER 1/2"

2058-BR BIT-RATCHET 1/4"

1544 FEELER GAUGE



FF1A09 - 34 pcs

111M COMBINATION WRENCH

6, 7, 8, 9, 10, 11, 12, 13, 14, 15, 16, 17, 18, 19, 21, 22, 24,

27, 30, 32

6M OPEN END WRENCH

6x7, 8x9, 10x11, 12x13, 14x15, 16x17, 18x19, 20x22, 24x27,

30x32

9071C ADJUSTABLE WRENCH CHROMED 8" ERGO™

1320RM RATCHET RING WRENCH

8x9, 10x11, 12x13

MIX

3/3 MODULE MIX COMPOSITION



ERGO TOOL MANAGEMENT SYSTEM

**FF1A10 - 66 pcs**

808050P PISTOL HANDLE RATCHETING SCREWDRIVER
 808050S RATCHETING SCREWDRIVER, STUBBY
 59S/S31-1 BITS SET 81 PCS: PH, PZ, TORX®, HEX, SL
 2047-0.8-4 OFFSET SCREWDRIVER 0.8X4X100
 2047PR-1-2 DOUBLE OFFSET KEY FOR PHILLIPS SCREWS PH1 & 2
 BE-8020L SCREWDRIVER ERGO™, SLOTTED 0.6X3X75
 BE-8030 SCREWDRIVER ERGO™, SLOTTED 0.6X3.5X75
 BE-8155 SCREWDRIVER ERGO™, SLOTTED 1.2X6.5X125
 BE-8260 SCREWDRIVER ERGO™, SLOTTED, HEX PROFILE & BOLSTER 1.6X8.0X175
 BE-8350 SCREWDRIVER ERGO™, SLOTTED, STUBBY 1X6.5X25
 BE-8601 / BE-8602 SCREWDRIVERS ERGO™, PHILLIPS, STUBBY PH1X25, PH2X25
 BE-8610 / BE-8630 SCREWDRIVERS ERGO™, PHILLIPS PH1X75, PH2X100, PH3X150
 BE-8910 / BE-8620 / BE-8940 SCREWDRIVERS ERGO™, TORX® T10X75, T15X100, T20X100, T25X125, T27X125, T30X150, T40X150
 BE-8770 BLACK HEX KEYS SET, LONG BALL END, 9 PCS, HEX 1.5, 2, 2.5, 3, 4, 5, 6, 8, 10
 MTB-3-16 MEASURING TAPE 3 m
 1150-1/2H/P CALIPER 150 mm
 1177-SCRIBE OFFSET SCRIBER 230 mm
 5515T-5Z TELESCOPIC SWIVEL HEAD MIRROR Ø 50 mm
 2820EF2 ELECTRICIANS KNIFE 200 mm

**FF1A11 - 16 pcs**

21016C SIDE CUTTERS ERGO™, 125, 160 mm
 21HDGC-200IP SIDE CUTTERS ERGO™, 203 mm
 2427 GC-200IP LONG, ROUND NOSE CHROMED PLIER, ERGO™, 200 mm
 2430 GC-200 IP SNIPER NOSE CHROMED PLIER, ERGO™, 200 mm
 2628 GC-160IP COMBINATION CHROMED PLIER, ERGO™, 160 mm
 8224CIP SLIP JOINT PLIER, ERGO™
 2951-250 GRIP WITH WIRE CUTTER, 250 mm
 2952-165 GRIP WITH EXTRA LONG NOSE
 2928-160 PLIER, FOR INTERNAL & EXTERNAL CIRCLIPS INT. 7-26 mm, EXT. 3-26 mm
 2928-200 PLIER, FOR INTERNAL & EXTERNAL CIRCLIPS INT. 10-51 mm, EXT. 7-51 mm
 2928-250 PLIER, FOR INTERNAL & EXTERNAL CIRCLIPS INT. 46-102 mm, EXT. 32-102 mm
 2928-1 / 2928-4 SPARE TIPS FOR 2928 SERIES
 BF1A01 Q3 LED-TORCH

**FF1A12 - 19 pcs**

481-300 / 481-500 DIN HAMMER, 300, 500 mm
 3625W-35 NYLON TIP HAMMER
 8158-1/2 BREAKER BAR 380 mm
 2509 FLEXIBLE PICK-UP TOOL 525 mm
 2535F2 MAGNETIC PICK-UP TOOL 1 kg
 3734 DRIFT PUNCHES Ø 3, 5, 8 mm
 3735-4-120 CENTRE PUNCH, 120 mm
 3740-150 FLAT CHISEL, 150 mm
 3745-150 CAPE CHISEL, 150 mm
 1-100-06-1-2 6" FLAT FILE WITH HANDLE, BASTARD
 1-100-06-2-2 6" FLAT FILE WITH HANDLE, SECOND
 1-160-06-1-2 6" SQUARE FILE WITH HANDLE, BASTARD
 1-210-06-1-2 6" HALF ROUND FILE WITH HANDLE, BASTARD
 1-230-06-1-2 6" ROUND FILE WITH HANDLE, BASTARD
 FS-8 SCISSORS, 7.5 cm BLADE
 319 HACKSAW FRAME AND BI-METAL SANDFLEX® BLADE

MIX

3/3 MODULE MIX COMPOSITION



ERGO TOOL MANAGEMENT SYSTEM

**FF1A13 - 82 pcs**

A6800DZ SOCKETS 1/4" LONG

3/16", 7/32", 1/4", 9/32", 5/16", 11/32", 3/8", 7/16", 1/2", 9/16"

A6800DM SOCKETS 1/4" LONG

4", 10"

6700SZ-5/32 SOCKET 1/4", SHORT

A6700DZ SOCKETS 1/4", SHORT

3/16", 7/32", 1/4", 9/32", 5/16", 11/32", 3/8", 7/16", 1/2", 9/16"

A6710DZ SWIVEL SOCKETS 1/4" LONG

3/16", 7/32", 1/4", 9/32", 5/16", 11/32", 3/8", 7/16", 1/2", 9/16"

6966 UNIVERSAL JOINT 1/4"

6950SL REVERSIBLE RATCHET 1/4", SLIMHEAD

6958 BREAKER BAR 1/4"

6954 T-HANDLE 1/4"

6956 SPINNER HANDLE 1/4"

6960 / 6961 / 6962 / 6962L EXTENSION BARS 1/4"
50, 100, 150, 355 mm

A7400DZ SOCKET 3/8" SHORT 1/4", 5/16", 3/8", 7/16", 1/2", 17/32", 9/16", 19/32", 5/8", 11/16", 3/4", 13/16", 7/8"

A7402DZ SOCKETS 3/8" LONG

1/4", 5/16", 3/8", 7/16", 1/2", 9/16", 5/8", 19/32", 11/16", 3/4", 13/16", 7/8"

7766 UNIVERSAL JOINT 3/8"

7750SL RATCHET 3/8", SLIMHEAD

7758 BREAKER BAR 3/8"

7754 T-HANDLE 3/8"

7752 SPEEDER 3/8"

7760 / 7761 / 7762 EXTENSION BARS 3/8"

75, 125, 260 mm

7764 ADAPTOR F 3/8" - M 1/4"

7765 ADAPTOR F 1/4" - M 3/8"

8165-1/2 ADAPTOR F 1/2" - M 3/8"

8164-1/2 ADAPTOR F 3/8" - M 1/2"

6972H BIT HOLDER 1/4"

7407H BIT HOLDER 3/8" - 1/4" - 3/8"

7408H BIT HOLDER 3/8" - 5/16" - 3/8"

S6106KA SOCKET SPARK PLUG 7/8"

**FF1A15 - 12 pcs**

8224CIP SLIP JOINT PLIER, ERGO™

2628 GC-160IP COMBINATION CHROMED PLIER, ERGO™
160 mm

2101GC SIDE CUTTING PLIER 125, 160 mm

2233D-240IP CABLE CUTTING PLIER 240 mm

2430 GC-200IP SNIPE NOSE PLIER 200 mm

2427 GC-200IP LONG, ROUND NOSE CHROMED PLIER,
ERGO™ 200 mm

2421GC-180IP FLAT NOSE PLIER 180 mm

2650 SLIP JOINT, CONNECTOR PLIER

2951-180 GRIP & WELDING PLIER 180 mm

2855 WIRE TWISTING PLIER 224 mm

2855 D WIRE TWISTING PLIER 282 mm

**FF1A14 - 43 pcs**

111Z COMBINATION WRENCHES

1/4", 5/16", 3/8", 7/16", 1/2", 9/16", 5/8", 11/16", 3/4", 13/16", 7/8", 15/16", 1"

1952Z-11/32 COMBINATION WRENCH

11/32"

1320RZ RATCHETING RING WRENCHES

1/4x5/16", 5/16x11/32", 3/8x7/16", 1/2x9/16"

1950MZ-3/8 CROWFOOT ADJUSTABLE WRENCH 3/8"

8069 C IP ADJUSTABLE CHROMEPIE WRENCH 4" 110x13 mm

9070C ADJUSTABLE WRENCH CHROMED 6" ERGO™
158x20 mm

1931Z LILIPUT DOUBLE OPEN-END WRENCHES

5/32", 3/16", 7/32", 1/4", 9/32", 5/16", 11/32", 3/8", 7/16", 1/2", 9/16"

6Z DOUBLE OPEN-END WRENCHES

1/4x5/16", 5/16x11/32", 3/8x7/16", 1/2x9/16",
19/32x11/16", 5/8x3/4", 25/32x13/16", 7/8x15/16",
15/16x1", 1x1 1/8", 1 1/16x1 1/4"

MIX

3/3 MODULE MIX COMPOSITION



ERGO TOOL MANAGEMENT SYSTEM

**FF1A16 - 18 pcs**

5515T POCKET TELESCOPIC MIRROR
Ø 30 mm

5515T-52 TELESCOPIC SWIVEL HEAD MIRROR
Ø 50 mm

1544 FEELER GAUGE

1150-1/2H/P CALIPER
150 mm

1179-FLX-2 FLEXIBLE MEASURE ROD
300 mm

MTB-3-16-E MEASURING TAPE
3 m

5471 F-145 GENERAL PURPOSE TWEEZER, STRAIGHT
145 mm

5516 GENERAL PURPOSE TWEEZER, ANGLE
150 mm

2744 MULTIPURPOSE SNIP
190 mm

2820EP2 ELECTRICIAN'S KNIFE WITH PLASTIC HANDLE
200 mm

2632 COMBINATION COTTER PIN EXTRACTOR AND SPREADER
170 mm

1177-SCRIBE OFFSET SCRIBER 230 mm

3525HB THREE SQUARE MACHINIST'S SCRAPER
80/185 mm

268 JUNIOR HACKSAW 150 mm

2509 FLEXIBLE PICK-UP TOOL 525 mm

2535F2 MAGNETIC PICK-UP TOOL 1 kg

KE18-01 CUTTER KNIFE ERGO™

BFLAD1 Q3 LED TORCH

**FF1A17 - 61 pcs**

BE-9780 BLACK HEX KEYS SET,
LONG BALL END, 12 PCS
0.050", 1/16", 5/64", 3/32", 7/64", 1/8", 9/64", 5/32", 3/16",
7/32", 1/4", 5/16"

BE-8020L / BE-8220 SLOTTED SCREWDRIVERS, ERGO™
0.5x3x75 mm, 0.5x3x125 mm

BE-8150 / BE-8155 SLOTTED SCREWDRIVERS, ERGO™
1x5x100 mm, 1.2x6.5x125 mm

BE-8260 SCREWDRIVER ERGO™
SLOTTED
1.6X8,0X175

BE-8610 / BE-8620 / BE-8630 PHILLIPS SCREWDRIVERS,
ERGO™
PH1X75 mm, PH2X100 mm, PH3X150 mm

BE-8601 / BE-8602 PHILLIPS SCREWDRIVERS, ERGO™
PH1X25 mm, PH2X25 mm

2047-1-5.5 DOUBLE OFFSET KEY FOR SLOTTED SCREWS
1X5,5X125 mm

2047PR-1-2 DOUBLE OFFSET KEY FOR PHILLIPS SCREWS
PH1 & 2

706-2 PRECISION SCREWDRIVERS SET, FOR SLOTTED &
PHILLIPS SCREWS
1.0X50, 1.2X50, 1.5X50, 1.8X50 mm, PH0, PH00

2058-DR BIT-RATCHET 1/4"

59/S28-4 BITS SET FOR SLOTTED, PHILLIPS, TORX®,
HEXAGON AND TORQ-SET® HEAD SCREWS
28 PCS

BE-9350 SCREWDRIVER ERGO™
SLOTTED, STUBBY
1X5,5X25

808050 RATCHETING BIT SCREWDRIVER

**FF1A18 - 25 pcs**

3736S/6 SET OF CHISELS
6 PCS

3734S/6 SET OF DRIFT PUNCHES
6 PCS
2-8 x 150 Ø mm

481 DIN HAMMER
200, 500 gr

3625N-35 SUPERFLEX PLASTIC HAMMER
35 mm

782-U GENERAL PURPOSE UTILITY WIRE BRUSH
290 mm

1-476-04-3-2-4" HAND FILE SET
WITH HANDLE, HAND, WARDING, SQUARE, THREE SQUARE,
HALF ROUND AND ROUND

2633/S4 SET INCLUDES AWL, HOOKS & PICKS, 4 PCS

MIX

3/3 MODULE MIX COMPOSITION



ERGO TOOL MANAGEMENT SYSTEM

**FF1A20 - 32 pcs**

2M-20-22 RING WRENCH
 2M-21-23 RING WRENCH
 2M-24-27 RING WRENCH
 2M-25-28 RING WRENCH
 2M-30-32 RING WRENCH
 4040M-10-11 FLEX HEAD SPANNER 10-11 MM
 4040M-12-13 FLEX HEAD SPANNER 12-13 MM
 4040M-14-15 FLEX HEAD SPANNER 14-15 MM
 4040M-16-17 FLEX HEAD SPANNER 16-17 MM
 4040M-18-19 FLEX HEAD SPANNER 18-19 MM
 4040M-20-22 FLEX HEAD SPANNER 20-22 MM
 4040M-21-23 FLEX HEAD SPANNER 21-23 MM
 4040M-8-9 FLEX HEAD SPANNER 8-9 MM
 6700SM-10 SOCKET 1/4
 6700SM-11 SOCKET 1/4
 6700SM-12 SOCKET 1/4

6700SM-13 SOCKET 1/4

6700SM-14 SOCKET 1/4

6700SM-4 SOCKET 1/4

6700SM-4.5 SOCKET 1/4

6700SM-5 SOCKET 1/4

6700SM-5.5 SOCKET 1/4

6700SM-6 SOCKET 1/4

6700SM-7 SOCKET 1/4

6700SM-8 SOCKET 1/4

6700SM-9 SOCKET 1/4

6950 RATCHET 1/4. PEAR TYPE 72T

6954 T-HANDLE

6956 SPINNER HANDLE 1/4

6960 EXTENSION 1/4 50MM

6962 EXTENSION 1/4 150MM

6966 UNIVERSAL JOINT

**FF1A5023 - 16 pcs**

819-3906 HACKSAW FRAME 819
 268 MINIHACKSAW FRAMES
 208 HACKSAW FRAMES
 2509 FLEX. PICK UP
 2444 CARPENTERS INMORA KNIFE
 2744 MULTI-PURPOSE SNIP
 6515T TELESCOPIC MIRROR
 BE-8020L SCREW DR ERGO 0.5X3X75
 BE-8040 SCREW DR ERGO 0.8X4.0X100
 BE-8150 SCREW DR ERGO 1.0X5.5X100
 BE-8255 SCREW DR ERGO 1.2X6.5X150
 BE-8256 SCREW DR ERGO 1.6X8.0X150
 BE-8340 SCREW DR ERGO 0.8X4.25
 BE-8501 SCREW DR ERGO PH1X25
 BE-8610 SCREW DR ERGO PH1X75
 BE-8620 SCREW DR ERGO PH2X100

MIX

3/3 MODULE MIX COMPOSITION



ERGO TOOL MANAGEMENT SYSTEM

**FF1A5016 - 28 pcs**

111M-6, 7, 8, 9, 10, 11, 12, 13, 14, 15, 16, 17, 18, 19, 20, COMBINATION WRENCH
 1419-MD MAGNETIC DISH
 BE-8906 SCREW.DR ERGO TX 6X75
 BE-8907 SCREW.DR ERGO TX 7X75
 BE-8908 SCREW.DR ERGO TX 8X75
 BE-8909 SCREW.DR ERGO TX 9X75
 BE-8910 SCREW.DR ERGO TX 10X75
 BE-8915 SCREW.DR ERGO TX 15X100
 BE-8920 SCREW.DR ERGO TX 20X100
 BE-8925 SCREW.DR ERGO TX 25X125
 BE-8927 SCREW.DR ERGO TX 27X125
 BE-8930 SCREW.DR ERGO TX 30X150
 BE-8940 SCREW.DR ERGO TX 40X150
 BE-8945 SCREW.DR ERGO TX 45X150

**FF1A5017 - 16 pcs**

3625N-35 PLASTIC HAMMER
 3734-2 DRIFT PUNCH
 3734-3 CUTTER PIN PUNCH
 3734-4 BOTADOR
 3734-5 CUTTER PIN PUNCH
 3734-6 DRIFT PUNCH
 3734-8 CUTTER PIN PUNCH
 3735-5-120 CENTER PUNCH
 3740-175 FLAT CHISEL
 481-400 GERMAN DIN-HAMMER
 111M-21, 22, 24, 27, 30, 32, COMBINATION WRENCH

**FF1A5018 - 26 pcs**

2628 G-180IP COMB PLIER 2628 G-180IP
 2101G-160IP SIDE CUTTER 2101G-160IP
 2430 G-160 IP SNIPE NOSE CUTTING 160 IP
 8224 IP SLIP JOINT PLIER 8224 W/O CARD
 BBR201P6 XZN 1/2 IMP SOCK BIT - BRAKE 6P
 BE5103 XZN 1/2 SOCKET W/BT-ENG 9P
 2M-10-11 RING WRENCH
 2M-12-13 RING WRENCH
 2M-14-15 RING WRENCH
 2M-16-17 RING WRENCH
 2M-18-19 RING WRENCH
 2M-6-7 RING WRENCH
 2M-8-9 RING WRENCH

MIX

3/3 MODULE MIX COMPOSITION



ERGO TOOL MANAGEMENT SYSTEM



FF1A2502 - 117 pcs

59S/31-1 BITS SET 31 PCS PH,PZ,T,HEX,SL

7400SM-6, 7, 8, 9, 10, 11, 12, 13, 14, 15, 16, 17, 18, 19, 20,

21, 22, SOCKET 3/8

7754 T-HANDLE 3/8

7755 3/8 RATCHET 3/8, ERGO

7760 EXTENSION 3/8, 75MM

7761 EXTENSION 3/8, 125MM

7762 EXTENSION 3/8, 250MM

7766 UNIVERSAL JOINT 3/8

7800SM- 8, 9, 10, 11, 12, 13, 14, 15, 16, 17, 18, 19, 21, 22,

23, 24, 26, 28, 30, 32, SOCKET 1/2

7805DM-10, 12, 13, 17, 19, SOCKET 1/2

7809M-5, 6, 7, 8, 9, 10, 12, 14, 17, 18, SOCKET DRIVER 1/2,
HEX 10

7809M-10-140 SOCKET DRIVER 1/2IN, HEX, LONG

7809M-5-180 SOCKET DRIVER 1/2IN, HEX, LONG

7809M-6-140 SOCKET DRIVER 1/2IN, HEX, LONG

7809M-7-100 SOCKET DRIVER 1/2IN, HEX, LONG

7809M-8-120 SOCKET DRIVER 1/2IN, HEX, LONG

7809TORX-T25, T30, T40, T45, T50, T55, SOCKET 1/2

808050 RATCHETING BIT SCREWDRIVER

8134-1/2 T-HANDLE

8155-1/2 ONE HANDLE RATCHET 1/2IN

8160-1/2 EXTENSION

8162-1/2 EXTENSION

8166-1/2 UNIVERSAL JOINT

BE-9678 SCREW DR SET HEX BALL 9 PCS

MTB-5-25 5M TAPE MEASURE 25MM

MIX

3/3 MODULE MIX COMPOSITION



ERGO TOOL MANAGEMENT SYSTEM

**FF1A5019 - 47 pcs**

111M COMBINATION WRENCH 6, 7, 8, 9, 10, 11, 12, 13, 14, 15, 16, 17, 18, 19, 20 mm

2101G-160IP SIDE CUTTER 160 mm

2430 G-160 IP SNIPER NOSE CUTTING 160 mm

2628 G-180IP COMBINATION PLIER 180 mm

7800DM SOCKET 1/2 8, 9, 10, 11, 12, 13, 14, 15, 16, 17, 18, 19, 20, 21, 22, 23, 24, 25, 26, 27, 28, 30, 32 mm

8154-1/2 T HANDLE 1/2

8155-1/2 RATCHET 1/2

8160-1/2 EXTENSION 125 mm

8162-1/2 EXTENSION 250 mm

8166-1/2 UNIVERSAL JOINT 1/2

8224 IP SLIP JOINT PLIER 250 mm

**FF1A1008 - 55 pcs**

59S/31-1 PZ1, PZ2 (x3), PZ3, PH1, PH2 (x3), PH3: PH2G (x2), T10, T15 (x3), T20 (x3), T26 (x2), T27 and T30. SL: 3, 4.5, 5.5mm; HEX: 3mm, 4, 5, 6mm. 1/4" Magnetic bit holder

BE-8020L SCREWDRIVER ERGO 0.5 X 3 X 75

808050 RATCHETING BIT SCREWDRIVER

BE-8040 SCREWDRIVER ERGO 0.8 X 4.0 X 100

BE-8150 SCREWDRIVER ERGO 1.0 X 6.5 X 100

BE-8255 SCREWDRIVER ERGO 1.2 X 6.5 X 150

BE-8256 SCREWDRIVER ERGO 1.6 X 8.0 X 150

BE-8340 SCREWDRIVER ERGO 0.8 X 4 X 25

BE-8601 SCREWDRIVER ERGO PH1 X 25

BE-8610 SCREWDRIVER ERGO PH1 X 75

BE-8620 SCREWDRIVER ERGO PH2 X 100

BE-8925 SCREWDRIVER ERGO TORX 25 X 125

BE-8927 SCREWDRIVER ERGO TORX 27 X 125

BE-8930 SCREWDRIVER ERGO TORX 30 X 150

BE-8940 SCREWDRIVER ERGO TORX 40 X 150

BE-8945 SCREWDRIVER ERGO TORX 45 X 150

BE-9678 BLACK KEYS SETS FOR HEX SCREWS, LONG BALL END 1.5, 2, 2.5, 3, 4, 5, 6, 8, 10

MIX

3/3 MODULE MIX COMPOSITION



ERGO TOOL MANAGEMENT SYSTEM

**FF1A5020 - 52 pcs**

111M COMBINATION WRENCH 6, 7, 8, 9, 10, 11, 12, 13, 14, 15, 16, 17, 18, 19, 20 mm

3625N-35 PLASTIC HAMMER

2951-180 GRIP 180 mm

2951-250 GRIP 250 mm

7800DM SOCKET 1/2 8, 9, 10, 11, 12, 13, 14, 15, 16, 17, 18, 19, 20, 21, 22, 23, 24, 25, 26, 27, 28, 30, 32 mm

7805DM 1/2 DEEP SOCKET 10, 12, 13, 17, 19

8154-1/2 T HANDLE 1/2

8155-1/2 RATCHET 1/2

8160-1/2 EXTENSION 125 mm

8162-1/2 EXTENSION 250 mm

8166-1/2 UNIVERSAL JOINT 1/2

8224 IP SLIP JOINT PLIER 250 mm

**FF1A5021 - 17 PCS**

BE-8020L SCREWDRIVER ERGO 0,6 X 3 X 75

BE-8040 SCREWDRIVER ERGO 0,8 X 4,0 X 100

BE-8150 SCREWDRIVER ERGO 1,0 X 5,5 X 100

BE-8255 SCREWDRIVER ERGO 1,2 X 6,5 X 150

BE-8256 SCREWDRIVER ERGO 1,6 X 8,0 X 150

BE-8340 SCREWDRIVER ERGO 0,8 X 4 X 25

BE-8601 SCREWDRIVER ERGO PH1 X 25

BE-8610 SCREWDRIVER ERGO PH1 X 75

BE-8620 SCREWDRIVER ERGOPH2 X 100

319-3906 HACKSAW FRAME

MTB-5-25 5M TAPE MEASURE 25 mm

208-3906 HACKSAW FRAMES

2444 CARPENTERS KNIFE

268 MINIHACKSAW FRAMES

5515T TELESCOPIC MIRROR

2509 FLEXIBLE PICK UP

2744 MULTI-PURPOSE SNIPER

MIX

3/3 MODULE MIX COMPOSITION



ERGO TOOL MANAGEMENT SYSTEM

**FF1A5022 - 26 pcs**

670SM SOCKET 1/4: 4, 4.5, 5, 5.5, 6, 7, 8, 9, 10, 11, 12, 13, 14 mm

6950 RATCHET 1/4 PEAR TYPE

6954 T-HANDLE

6956 SPINNER HANDLE 1/4

6960 EXTENSION 1/4 50 mm

6962 EXTENSION 1/4 150 mm

6966 UNIVERSAL JOINT 1/4

8070 ADJUSTABLE WRENCH 6"

9031 ADJUSTABLE WRENCH

9072 P COMBINATION ADJUSTABLE WRENCH P 10"

141 PIPE WRENCH

2101G-160IP SIDE CUTTER 160 mm

2430 G-160 IP SNIPER NOSE CUTTING 160 mm

2628 G-180IP COMBINATION PLIER 180 mm

**FF1A1009 - 49 pcs**

901T-010-100 TORX T-HANDLE 10 X 100

901T-015-150 TORX T-HANDLE 15 X 150

901T-020-150 TORX T-HANDLE 20 X 150

901T-025-150 TORX T-HANDLE 25 X 150

901T-027-150 TORX T-HANDLE 27 X 150

901T-030-200 TORX T-HANDLE 30 X 200

901T-040-200 TORX T-HANDLE 40 X 200

808050 RATCHETING BIT SCREWDRIVER

59S/31-1 PZ1, PZ2 (x3), PZ3, PH1, PH2 (x3), PH3, PH2G (x2), T10, T15 (x3), T20 (x3), T25 (x2), T27, T30, SL: 3, 4, 5, 5.5 mm; HEX: 3 mm, 4, 5, 6 mm 1/4" Magnetic bit holder

1419-MD MAGNETIC DISH

BE-9678 BLACK KEYS SETS FOR HEX SCREWS, LONG BALL END 1.5, 2, 2.5, 3, 4, 5, 6, 8, 10 mm

MIX

3/3 MODULE MIX COMPOSITION



ERGO TOOL MANAGEMENT SYSTEM

**FF1A5021 - 16 pcs**

208-3906 HACKSAW FRAMES

2444 CARPENTERS KNIFE

2509 FLEX. PICK UP

268 MINIHACKSAW FRAMES

2744 MULTI-PURPOSE SNIP

319-3906 HACKSAW FRAME

5515T TELESCOPIC MIRROR

BE-8020L SCREWDRIVER ERGO 0.5 X 3 X 7BE-8040

BE-8040 SCREWDRIVER ERGO 0.8 X 4.0 X 100

BE-8150 SCREWDRIVER ERGO 1.0 X 5.5 X 100

BE-8255 SCREWDRIVER ERGO 1.2 X 6.5 X 150

BE-8256 SCREWDRIVER ERGO 1.6 X 8.0 X 150

BE-8340 SCREWDRIVER ERGO 0.8 X 4 X 25

BE-8601 SCREWDRIVER ERGO PH1 X 25

BE-8610 SCREWDRIVER ERGO PH1 X 75

BE-8620 SCREWDRIVER ERGO PH2 X 100

**FF1A5022 - 28 pcs**

111M COMBINATION WRENCH 6, 7, 8, 9, 10, 11, 12, 13 mm

1RM RATCHET COMB.SPANNER 8, 9, 10, 11, 12, 13, 14, 15, 16, 17, 18, 19 mm

2101G-160IP SIDE CUTTER 160 mm

2430 G-160 IP SNIPE NOSE CUTTING 160 mm

141 PIPE WRENCH

2628 G-180IP COMBINATION PLIER 180 mm

9031 ADJUSTABLE WRENCH

9072 P COMB ADJUSTABLE P 10"

8070 ADJUSTABLE WRENCH 6"

8224 IP SLIP JOINT PLIER 250 mm

MIX

3/3 MODULE MIX COMPOSITION



ERGO TOOL MANAGEMENT SYSTEM

**FF1A5025 - 57 pcs**

1419-MD MAGNETIC DISH
 39/S31 IMPACT BITS SET 31 PCS
 BE-9678 BLACK KEYS SETS FOR HEX SCREWS,
 LONG BALL END 1.5, 2, 2.5, 3, 4, 5, 6, 8, 10 mm
 7809M SOCKET 1/2, HEX 5, 6, 7, 8, 9, 10, 12, 14, 17, 19 mm
 7809M-10-140 SOCKET 1/2 HEX LONG
 7809M-5-180 SOCKET 1/2 HEX LONG
 7809M-6-140 SOCKET 1/2 HEX LONG
 7809M-7-100 SOCKET 1/2 HEX LONG
 7809M-8-120 SOCKET 1/2 HEX LONG
 808050 RATCHETING BIT SCREWDRIVER

**FF1A5026 - 84 pcs**

6700SM SOCKET 1/4 4, 4.5, 5, 5.5, 6, 7, 8, 9, 10, 11, 12,
 13, 14 mm
 6950 RATCHET 1/4, PEAR TYPE 72T
 6954 T-HANDLE 1/4
 6956 SPINNER HANDLE 1/4
 6960 EXTENSION 1/4 50 mm
 6962 EXTENSION 1/4 150 mm
 6966 UNIVERSAL JOINT 1/4
 7400SM SOCKET 3/8 6, 7, 8, 9, 10, 11, 12, 13, 14, 15, 16, 17,
 18, 19, 20, 21, 22 mm
 7754 T-HANDLE 3/8
 7755 3/8 RATCHET 3/8, ERGO
 7760 EXTENSION 3/8, 75 mm
 7761 EXTENSION 3/8, 125 mm
 7762 EXTENSION 3/8, 250 mm
 7766 UNIVERSAL JOINT 3/8
 7800DM SOCKET 1/2, 8, 9, 10, 11, 12, 13, 14, 15, 16, 17, 18,
 19, 20, 21, 22, 23, 24, 25, 26, 27, 28, 29, 30, 32 mm
 7805DM 1/2 DEEP SOCKET 10, 12, 13, 17, 19 mm
 8154-1/2 T HANDLE 1/2
 8155-1/2 RATCHET 1/2
 8160-1/2 EXTENSION 125 mm
 8162-1/2 EXTENSION 250 mm
 8166-1/2 UNIVERSAL JOINT 1/2
 111M COMBINATION WRENCH 14, 15, 16, 17, 18, 19, 20 mm
 MTB-5-25 5M TAPE MEASURE 25 mm

MIX

3/3 MODULE MIX COMPOSITION



ERGO TOOL MANAGEMENT SYSTEM

**FF1A19 - 33 pcs**

111M - COMBINATION WRENCH 6,7,8,9,10,11,12,13,14,
15,16,17,18,19,20,21,22,24,27,30,32 mm
6M - OPEN END WRENCH 6-7,8-9,10-11,12-13,14-15,
16-17,18-19,20-22,21-23,24-27,30-32
92C ADJUSTABLE WRENCH 8" SIDE NUT

**FF1A20 - 18 pcs**

2M-6-7 RING WRENCH
2M-8-9 RING WRENCH
2M-10-11 RING WRENCH
2M-12-13 RING WRENCH
2M-14-15 RING WRENCH
2M-16-17 RING WRENCH
2M-18-19 RING WRENCH
2M-20-22 RING WRENCH
2M-21-23 RING WRENCH
2M-24-27 RING WRENCH
2M-30-32 RING WRENCH
4040M-10-11 FLEX HEAD SPANNER 10-11 mm
4040M-12-13 FLEX HEAD SPANNER 12-13 mm
4040M-14-15 FLEX HEAD SPANNER 14-15 mm
4040M-16-17 FLEX HEAD SPANNER 16-17 mm
4040M-18-19 FLEX HEAD SPANNER 18-19 mm
4040M-21-23 FLEX HEAD SPANNER 21-23 mm
2953-250 UNIVLOCKING CURVED PLIER 250

**FF1A21 - 51 pcs**

59S/31-T BITS SET 31PCS PH,PZ,T,HEX,SL
BE-8257 SCREW.DR ERGO 1.6X8.0X175
BE-8255 SCREW.DR ERGO 1.2X6.5X150
BE-8242 SCREW.DR ERGO 1.0X5.5X150
BE-8040 SCREW.DR ERGO 0.8X4.0X100
BE-8030 SCREW.DR ERGO 0.6X3.5X75
BE-8611 SCREW.DR ERGO PH2X75
BE-8620 SCREW.DR ERGO PH2X100
BE-8910 SCREW.DR ERGO TX 10X75
BE-8915 SCREW.DR ERGO TX 15X100
BE-8920 SCREW.DR ERGO TX 20X100
BE-8925 SCREW.DR ERGO TX 25X125
BE-8927 SCREW.DR ERGO TX 27X125
BE-8930 SCREW.DR ERGO TX 30X150
BE-8940 SCREW.DR ERGO TX 40X150
BE-8577 SCREW.DR ERGO 1/4 BIT HOLDER
BE-8355 SCREW.DR ERGO 1.2X6.5X25
BE-8602 SCREW.DR ERGO PH2X25
2446 STAINLESS STEEL CARPENTER KNIF
BE-9678 SCREW.DR SET HEX BALL 9 PCS
BE-9575 SCREW.DR SET TORX 8PCS

MIX

3/3 MODULE MIX COMPOSITION



ERGO TOOL MANAGEMENT SYSTEM

**FF1A22 - 58 pcs**

7800SM-10, 12, 13, 14, 15, 16, 17, 18, 19, 21, 22, 23, 24, 27, 30, 32. SOCKET 1/2

7805SM-13, 16, 17, 18, 19, 21, 22, 24, 27, 30, 32. SOCKET DEEP 1/2

7809M-5, 6, 8, 10, 12, 14. SOCKET DRIVER 1/2

8158-1/2. BREAKER BAR

8154-1/2. T-HANDLE

8159-1/2. EXTENSION

8160-1/2. EXTENSION

8166-1/2. UNIVERSAL JOINT

8150SL. RATCHET 1/2. SLIM HEAD 72T

6700SM-4, 4.5, 5, 5.5, 6, 7, 8, 9, 10, 11, 12, 13. SOCKET 1/4

6958. BREAKER BAR

6954. T-HANDLE

6960. EXTENSION 1/4 50 mm

6962. EXTENSION 1/4 150 mm

6966. UNIVERSAL JOINT

6950SL. RATCHET 1/4. SLIM HEAD 72T

4532-A. UNIV. TWO-ARM PULLER

**FF1A23 - 21 pcs**

3735-4-120. PUNCH

3734-2. COTTER PIN PUNCH

3734-3. COTTER PIN PUNCH

3734-4. COTTER PIN PUNCH

3734-5. COTTER PIN PUNCH

3734-6. COTTER PIN PUNCH

3734-8. COTTER PIN PUNCH

2630GC-180IP. COMBINATION PLIER 180 mm ERGO

2430 GC-200 IP. SNIPER NOSE CUTTING CHROME 200

2427 GC-200IP. LONG ROUND NOSE CHROME PL200

2900-180. CIRCLIP PLIER 2900-180

2890-180. CIRCLIP PLIER 2890-180

2990-180. CIRCLIP PLIER 2990-180

2800-180. CIRCLIP PLIER 2800-180

7224. SLIP JOINT PLIER 250 mm

2101GC-160IP. SIDE CUTTER 2101GC-160

479-16. DIN HAMMER

3625N-35. PLASTIC HAMMER

1547. FEELER GAUGE

MTB-3-16. 3M. TAPE MEASURE 16 mm

SC127. ELECTRICIAN'S SCISSORS 5"130 mm

MIX

3/3 MODULE MIX COMPOSITION



ERGO TOOL MANAGEMENT SYSTEM

**FF1A24 - 19 pcs**

3735-4-120 PUNCH
 3734-2 CUTTER PIN PUNCH
 3734-3 CUTTER PIN PUNCH
 3734-4 CUTTER PIN PUNCH
 3734-5 CUTTER PIN PUNCH
 3734-6 CUTTER PIN PUNCH
 3734-8 CUTTER PIN PUNCH
 2630GC-180IP COMBINATION PLIER 180 mm ERGO
 2430 GC-200 IP SNIPE NOSE CUTTING CHROME 200
 2900-180 CIRCLIP PLIER 2900-180
 2890-180 CIRCLIP PLIER 2890-180
 2990-180 CIRCLIP PLIER 2990-180
 2800-180 CIRCLIP PLIER 2800-180
 7224 SLIP JOINT PLIER 250 mm
 2101GC-160IP SIDE CUTTER 2101GC-160
 479-16 DIN HAMMER
 3625N-35 PLASTIC HAMMER
 MTB-3-16 3M TAPE MEASURE 16 mm
 SC127 ELECTRICIAN'S SCISSORS 5" 130 mm

FF1A25 - 51 pcs

7800SM - 10, 12, 13, 14, 15, 16, 17, 18, 19, 21,
 22, 23, 24, 27, 30, 32 SOCKET 1/2
 7805SM-13, 16, 17, 18, 19, 21, 22, 24, 27, 30, 32,
 SOCKET DEEP 1/2
 8154-1/2 T HANDLE
 8159-1/2 EXTENSION
 8160-1/2 EXTENSION
 8166-1/2 UNIVERSAL JOINT
 8150SL RATCHET 1/2, SLIM HEAD 72T
 6700SM - 4, 4.5, 5, 5.5, 6, 7, 8, 9, 10, 11, 12, 13,
 SOCKET 1/4
 6954 T-HANDLE
 6960 EXTENSION 1/4 50 mm
 6962 EXTENSION 1/4 150 mm
 6966 UNIVERSAL JOINT
 6950SL RATCHET 1/4, SLIM HEAD 72T
 2953-250 UNWLOCKING CURVED PLIER 250

MIX

3/3 MODULE MIX COMPOSITION

BAHCO

ERGO TOOL MANAGEMENT SYSTEM

**FF1A26 - 27 pcs**

111M-6, 7, 8, 9, 10, 11, 12, 13, 14, 15, 16, 17, 18, 19, 20, 21, 22, 24, 27, 30, 32, COMBINATION WRENCH
 2630GC-180IP COMBINATION PLIER 180 mm ERGO
 2430 GC-200 IP SNIPER NOSE CUTTING CHROME 200
 7224 SLIP JOINT PLIER 250 mm
 2953-250 UNIV. LOCKING CURVED PLIER 250
 2101GC-160IP SIDE CUTTER 2101GC 160
 SC127 ELECTRICIAN'S SCISSORS 5"130 mm

**FF1A27 - 58 pcs**

59S/31-1 BITS SET 31PCS PH,PZ,T,HEX,SL
 BE-8257 SCREW.DR.ERGO 1,6X8,0X175
 BE-8255 SCREW.DR.ERGO 1,2X6,5X150
 BE-8242 SCREW.DR.ERGO 1,0X5,5X150
 BE-8049 SCREW.DR.ERGO 0,8X4,0X100
 BE-8030 SCREW.DR.ERGO 0,6X3,5X75
 BE-8611 SCREW.DR.ERGO PH1X75
 BE-8620 SCREW.DR.ERGO PH2X100
 BE-8910 SCREW.DR.ERGO TX 10X75
 BE-8915 SCREW.DR.ERGO TX 15X100
 BE-8920 SCREW.DR.ERGO TX 20X100
 BE-8925 SCREW.DR.ERGO TX 25X125
 BE-8927 SCREW.DR.ERGO TX 27X125
 BE-8930 SCREW.DR.ERGO TX 30X150
 BE-8940 SCREW.DR.ERGO TX 40X150
 BE-8577 SCREW.DR.ERGO 1/4 BIT HOLDER
 BE-8355 SCREW.DR.ERGO 1,2X6,5X25
 BE-8602 SCREW.DR.ERGO PH2X25
 BE-9678 SCREW.DR. SET HEX BALL 9 PCS
 BE-9675 SCREW.DR. SET TORX 8PCS

**FF1A28 - 48 pcs**

7800SM-10, 12, 13, 14, 15, 16, 17, 18, 19, 21, 22, 23, 24, 27, 30, 32 SOCKET 1/2
 8154-1/2 T HANDLE
 8159-1/2 EXTENSION
 8160-1/2 EXTENSION
 8166-1/2 UNIVERSAL JOINT
 8150SL RATCHET 1/2, SLIM HEAD 72T
 6700SM-4, 4.5, 5, 5.5, 6, 7, 8, 9, 10, 11, 12, 13 SOCKET 1/4
 6954 T-HANDLE
 6960 EXTENSION 1/4 50MM
 6962 EXTENSION 1/4 150MM
 6966 UNIVERSAL JOINT
 6950SL RATCHET 1/4, SLIM HEAD 72T
 3735-4-120 PUNCH
 3734-2 COTTER PIN PUNCH
 3734-3 COTTER PIN PUNCH
 3734-4 COTTER PIN PUNCH
 3734-5 COTTER PIN PUNCH
 3734-6 COTTER PIN PUNCH
 3734-8 COTTER PIN PUNCH
 479-16 DIN HAMMER
 3625N-35 PLASTIC HAMMER
 MTB-3-16 3M TAPE MEASURE 16MM

MIX

3/3 MODULE MIX COMPOSITION

- Double Ring end Wrenches
- Flex Head Wrenches
- Open Ring Wrenches



ERGO TOOL MANAGEMENT SYSTEM



FF1A5001 - 19 pcs

2430 G-200 IP SNIPE NOSE CUTTING 200 mm
 2101G-160IP SIDE CUTTER 160 mm
 2628 G-180IP COMB PLIER 180 mm
 2951-180 GRIP WITH WIRE CUTTER 180 mm
 7224 SLIP JOINT PLIER 250 mm
 BE-8150 SCREW.DR ERGO 1.0 X 5.5 X 100
 BE-8155 SCREW.DR ERGO 1.2 X 6.5 X 125
 BE-8355 SCREW.DR ERGO 1.2 X 6.5 X 25
 BE-8256 SCREW.DR ERGO 1.2 X 8.0 X 150
 BE-8611 SCREW.DR ERGO PH1 X 75
 BE-8602 SCREW.DR ERGO PH2 X 25
 BE-8620 SCREW.DR ERGO PH2 X 100
 BE-8910 SCREW.DR ERGO TX 10 X 65
 BE-8915 SCREW.DR ERGO TX 15 X 70
 BE-8920 SCREW.DR ERGO TX 20 X 80
 BE-8925 SCREW.DR ERGO TX 25 X 80
 BE-8930 SCREW.DR ERGO TX 30 X 100
 BE-8940 SCREW.DR ERGO TX 40 X 130
 BE-9770 SCREW.DR SET HEX 1.5-10



FF1A5002 - 27 pcs

111M-6 COMBINATION WRENCH
 111M-7 COMBINATION WRENCH
 111M-8 COMBINATION WRENCH
 111M-9 COMBINATION WRENCH
 111M-10 COMBINATION WRENCH
 111M-11 COMBINATION WRENCH
 111M-12 COMBINATION WRENCH
 111M-13 COMBINATION WRENCH
 111M-14 COMBINATION WRENCH
 111M-15 COMBINATION WRENCH
 111M-16 COMBINATION WRENCH
 111M-17 COMBINATION WRENCH
 111M-18 COMBINATION WRENCH
 111M-19 COMBINATION WRENCH
 111M-20 COMBINATION WRENCH
 111M-21 COMBINATION WRENCH
 111M-22 COMBINATION WRENCH
 111M-24 COMBINATION WRENCH
 111M-27 COMBINATION WRENCH
 111M-30 COMBINATION WRENCH
 111M-32 COMBINATION WRENCH
 3734S/6 COMBINATION WRENCH



FF1A5003 - 91 pcs

111M-8 COMBINATION WRENCH
 111M-10 COMBINATION WRENCH
 111M-12 COMBINATION WRENCH
 111M-13 COMBINATION WRENCH
 111M-15 COMBINATION WRENCH
 111M-17 COMBINATION WRENCH
 111M-19 COMBINATION WRENCH
 6700SM-5 SOCKET 1/4
 6700SM-5.5 SOCKET 1/4
 6700SM-6 SOCKET 1/4
 6700SM-7 SOCKET 1/4
 6700SM-8 SOCKET 1/4
 6700SM-9 SOCKET 1/4
 6700SM-10 SOCKET 1/4
 6700SM-11 SOCKET 1/4
 6700SM-12 SOCKET 1/4
 6700SM-13 SOCKET 1/4
 6700SM-14 SOCKET 1/4
 6700TORX-E4 SOCKET 1/4
 6700TORX-E5 SOCKET 1/4

MIX

3/3 MODULE MIX COMPOSITION



ERGO TOOL MANAGEMENT SYSTEM

**FF1A5003 - 91 pcs**

6700TORX-E6 SOCKET 1/4

6700TORX-E7 SOCKET 1/4

6700TORX-E8 SOCKET 1/4

6700TORX-E10 SOCKET 1/4

6709TORX-T8 SOCKET 1/4

6709TORX-T9 SOCKET 1/4

6709TORX-T10 SOCKET 1/4

6709TORX-T15 SOCKET 1/4

6709TORX-T20 SOCKET 1/4

6709TORX-T25 SOCKET 1/4

6709TORX-T27 SOCKET 1/4

6709TORX-T30 SOCKET 1/4

6709TORX-T40 SOCKET 1/4

6950 RATCHET 1/4

6961 EXTENSION

6962 EXTENSION

6966 UNIVERSAL JOINT

7400SM-8 SOCKET 3/8

7400SM-9 SOCKET 3/8

7400SM-10 SOCKET 3/8

7400SM-11 SOCKET 3/8

7400SM-12 SOCKET 3/8

7400SM-13 SOCKET 3/8

7400SM-14 SOCKET 3/8

7400SM-15 SOCKET 3/8

7400SM-16 SOCKET 3/8

7400SM-17 SOCKET 3/8

7400SM-18 SOCKET 3/8

7400SM-19 SOCKET 3/8

7400SM-21 SOCKET 3/8

7400SM-22 SOCKET 3/8

7400TORX-E8 SOCKET 3/8

7400TORX-E10 SOCKET 3/8

7400TORX-E11 SOCKET 3/8

7400TORX-E12 SOCKET 3/8

7400TORX-E14 SOCKET 3/8

7400TORX-E16 SOCKET 3/8

7400TORX-E18 SOCKET 3/8

7409TORX-T25 SOCKET 3/8

7409TORX-T27 SOCKET 3/8

7409TORX-T30 SOCKET 3/8

7409TORX-T40 SOCKET 3/8

7409TORX-T45 SOCKET 3/8

7409TORX-T50 SOCKET 3/8

7750 RATCHET 3/8

7760 EXTENSION 3/8

7761 EXTENSION 3/8

7762 EXTENSION 3/8

7764 ADAPTOR 3/8

7765 ADAPTOR 3/8

7766 UNIVERSAL JOINT 3/8

8158-1/2 BREAKER BAR 3/8

A6800DM-6 SOCKET 1/4, LONG

A6800DM-7 SOCKET 1/4, LONG

A6800DM-8 SOCKET 1/4, LONG

A6800DM-9 SOCKET 1/4, LONG

A6800DM-10 SOCKET 1/4, LONG

A6800DM-11 SOCKET 1/4, LONG

A6800DM-12 SOCKET 1/4, LONG

A6800DM-13 SOCKET 1/4, LONG

A6800DM-14 SOCKET 1/4, LONG

A7402DM-10 SOCKET 3/8, LONG

A7402DM-11 SOCKET 3/8, LONG

A7402DM-12 SOCKET 3/8, LONG

A7402DM-13 SOCKET 3/8, LONG

A7402DM-14 SOCKET 3/8, LONG

A7402DM-15 SOCKET 3/8, LONG

A7402DM-16 SOCKET 3/8, LONG

A7402DM-17 SOCKET 3/8, LONG

A7402DM-18 SOCKET 3/8, LONG

A7402DM-19 SOCKET 3/8, LONG

MIX

3/3 MODULE MIX COMPOSITION



ERGO TOOL MANAGEMENT SYSTEM

**FF1A3004 - 30 pcs**

111M-6 COMBINATION WRENCH
 111M-7 COMBINATION WRENCH
 111M-8 COMBINATION WRENCH
 111M-9 COMBINATION WRENCH
 111M-10 COMBINATION WRENCH
 111M-11 COMBINATION WRENCH
 111M-12 COMBINATION WRENCH
 111M-13 COMBINATION WRENCH
 111M-14 COMBINATION WRENCH
 111M-15 COMBINATION WRENCH
 111M-16 COMBINATION WRENCH
 111M-17 COMBINATION WRENCH
 111M-18 COMBINATION WRENCH
 111M-19 COMBINATION WRENCH
 111M-20 COMBINATION WRENCH
 111M-21 COMBINATION WRENCH
 111M-22 COMBINATION WRENCH
 111M-24 COMBINATION WRENCH
 1RM-8 RATCHET WRENCH
 1RM-9 RATCHET WRENCH
 1RM-10 RATCHET WRENCH
 1RM-11 RATCHET WRENCH
 1RM-12 RATCHET WRENCH
 1RM-13 RATCHET WRENCH
 1RM-14 RATCHET WRENCH
 1RM-15 RATCHET WRENCH
 1RM-16 RATCHET WRENCH
 1RM-17 RATCHET WRENCH
 1RM-18 RATCHET WRENCH
 1RM-19 RATCHET WRENCH

**FF1A5004 - 37 pcs**

1RM-6 RATCHET WRENCH
 1RM-7 RATCHET WRENCH
 1RM-8 RATCHET WRENCH
 1RM-9 RATCHET WRENCH
 1RM-10 RATCHET WRENCH
 1RM-11 RATCHET WRENCH
 1RM-12 RATCHET WRENCH
 1RM-13 RATCHET WRENCH
 1RM-17 RATCHET WRENCH
 1RM-19 RATCHET WRENCH
 1RM-22 RATCHET WRENCH
 1RM-24 RATCHET WRENCH
 1RM-27 RATCHET WRENCH
 6700SM-10 SOCKET 1/4
 6700SM-11 SOCKET 1/4
 6700SM-12 SOCKET 1/4
 6700SM-13 SOCKET 1/4
 6700SM-6 SOCKET 1/4
 6700SM-7 SOCKET 1/4

6700SM-8 SOCKET 1/4
 6700SM-9 SOCKET 1/4
 6950 RATCHET 1/4
 6960 EXTENSION 1/4
 6966 UNIVERSAL JOINT 1/4
 7800SM-13 SOCKET 1/2
 7800SM-17 SOCKET 1/2
 7800SM-19 SOCKET 1/2
 7800SM-22 SOCKET 1/2
 7800SM-22 SOCKET 1/2
 7800SM-24 SOCKET 1/2
 7800SM-27 SOCKET 1/2
 7800SM-30 SOCKET 1/2
 7800SM-32 SOCKET 1/2
 8155-1/2 ONE HANDLE RATCHET 1/2
 8160-1/2 EXTENSION
 8166-1/2 UNIVERSAL JOINT
 SBS64 BAHCO T-HANDLE 1/4
 SBS86 BAHCO SLIDING T-HANDLE 1/2

MIX

3/3 MODULE MIX COMPOSITION



ERGO TOOL MANAGEMENT SYSTEM



FF1A5005 - 83 pcs

111M-13 COMBINATION WRENCH

111M-15 COMBINATION WRENCH

111M-17 COMBINATION WRENCH

111M-19 COMBINATION WRENCH

111M-8 COMBINATION WRENCH

6700SM-10 SOCKET 1/4

6700SM-11 SOCKET 1/4

6700SM-12 SOCKET 1/4

6700SM-13 SOCKET 1/4

6700SM-14 SOCKET 1/4

6700SM-4 SOCKET 1/4

6700SM-5 SOCKET 1/4

6700SM-6 SOCKET 1/4

6700SM-7 SOCKET 1/4

6700SM-8 SOCKET 1/4

6700SM-9 SOCKET 1/4

6709M-3 SOCKET 1/4

6709M-4 SOCKET 1/4

6709M-5 SOCKET 1/4

6709M-6 SOCKET 1/4

6709M-8 SOCKET 1/4

6950SL RATCHET 1/4, SLIM HEAD 72T

6960-W WOBBLE EXTENSION 1/4 - 50 mm

6962 EXTENSION 1/4

6962-W WOBBLE EXTENSION 1/4 - 150 mm

6968 SMOOTH OPERATION U.JOINT-1/4

7400SM-10 SOCKET 3/8

7400SM-11 SOCKET 3/8

7400SM-12 SOCKET 3/8

7400SM-13 SOCKET 3/8

7400SM-14 SOCKET 3/8

7400SM-15 SOCKET 3/8

7400SM-16 SOCKET 3/8

7400SM-17 SOCKET 3/8

7400SM-18 SOCKET 3/8

7400SM-6 SOCKET 3/8

7400SM-7 SOCKET 3/8

7400SM-8 SOCKET 3/8

7400SM-9 SOCKET 3/8

7750SL RATCHET 3/8, SLIM HEAD 72T

7760-W WOBBLE EXTENSION 3/8 - 75 mm

7761 EXTENSION 3/8

7768 SMOOTH OPERATION U.JOINT-3/8

7800SM-10 SOCKET 1/2

7800SM-11 SOCKET 1/2

7800SM-12 SOCKET 1/2

7800SM-13 SOCKET 1/2

7800SM-14 SOCKET 1/2

7800SM-15 SOCKET 1/2

7800SM-16 SOCKET 1/2

7800SM-17 SOCKET 1/2

7800SM-18 SOCKET 1/2

7800SM-19 SOCKET 1/2

7800SM-21 SOCKET 1/2

7800SM-22 SOCKET 1/2

7800SM-24 SOCKET 1/2

7800SM-27 SOCKET 1/2

7800SM-30 SOCKET 1/2

7800SM-32 SOCKET 1/2

7800SM-8 SOCKET 1/2

7800SM-9 SOCKET 1/2

7809M-10 SOCKET 1/2

7809M-12 SOCKET 1/2

7809M-14 SOCKET 1/2

7809M-17 SOCKET 1/2

7809M-5 SOCKET 1/2

7809M-6 SOCKET 1/2

7809M-7 SOCKET 1/2

7809M-8 SOCKET 1/2

7809TORX-T20 SOCKET 1/2

7809TORX-T25 SOCKET 1/2

7809TORX-T30 SOCKET 1/2

7809TORX-T40 SOCKET 1/2

7809TORX-T45 SOCKET 1/2

8150SL RATCHET 1/2, SLIM HEAD 72T

8160-1/2 EXTENSION 1/2

8162-1/2 EXTENSION 1/2

8166-1/2 UNIVERSAL JOINT 1/2

A6709M-2.5 SOCKET 1/4, LONG

A6709M-3 SOCKET 1/4, LONG

A6709M-4 SOCKET 1/4, LONG

A6709M-5 SOCKET 1/4, LONG

A6709M-6 SOCKET 1/4, LONG

MIX

3/3 MODULE MIX COMPOSITION



ERGO TOOL MANAGEMENT SYSTEM

**FF1A5006 - 27 pcs**

1-100-08-2-2 8" HAND, WITH HANDLE.CUT 2

1-210-08-2-2 8" 1/2 ROUND, WITH HANDLE.CUT 2

1-230-06-2-2 6" ROUND, WITH HANDLE.CUT 2

1-230-10-2-2 10" ROUND, WITH HANDLE.CUT 2

111M-7 COMBINATION WRENCH

111M-8 COMBINATION WRENCH

111M-9 COMBINATION WRENCH

111M-10 COMBINATION WRENCH

111M-11 COMBINATION WRENCH

111M-12 COMBINATION WRENCH

111M-13 COMBINATION WRENCH

111M-14 COMBINATION WRENCH

111M-15 COMBINATION WRENCH

111M-16 COMBINATION WRENCH

111M-17 COMBINATION WRENCH

111M-18 COMBINATION WRENCH

111M-19 COMBINATION WRENCH

111M-21 COMBINATION WRENCH

111M-22 COMBINATION WRENCH

1320RM-6-7 RATCHET WRENCH DOUBLE FLAT

1320RM-8-9 RATCHET WRENCH DOUBLE FLAT

1320RM-10-11 RATCHET WRENCH DOUBLE FLAT

1320RM-12-13 RATCHET WRENCH DOUBLE FLAT

1320RM-14-15 RATCHET WRENCH DOUBLE FLAT

1320RM-16-17 RATCHET WRENCH DOUBLE FLAT

1320RM-18-19 RATCHET WRENCH DOUBLE FLAT

1320RM-22-24 RATCHET WRENCH DOUBLE FLAT

MIX

3/3 MODULE MIX COMPOSITION



ERGO TOOL MANAGEMENT SYSTEM



FF1A5007 - 60 pcs

K6650-1/4 ADAPTOR 1/4" 50 mm 1/4 W/PIN

3734-2 COTTER PIN PUNCH

3734-3 COTTER PIN PUNCH

3734-4 COTTER PIN PUNCH

3734-5 COTTER PIN PUNCH

3734-6 COTTER PIN PUNCH

3734-8 COTTER PIN PUNCH

481-400 GERMAN DIN-HAMMER

6700SM-10 SOCKET 1/4

6700SM-11 SOCKET 1/4

6700SM-12 SOCKET 1/4

6700SM-13 SOCKET 1/4

6700SM-14 SOCKET 1/4

6700SM-4 SOCKET 1/4

6700SM-5 SOCKET 1/4

6700SM-6 SOCKET 1/4

6700SM-7 SOCKET 1/4

6700SM-8 SOCKET 1/4

6700SM-9 SOCKET 1/4

6709F-5.5 SOCKET 1/4

6709F-8 SOCKET 1/4

6709M-3 SOCKET 1/4

6709M-4 SOCKET 1/4

6709M-5 SOCKET 1/4

6709M-6 SOCKET 1/4

6709PH-1 SOCKET 1/4

6709PH-2 SOCKET 1/4

6950SL RATCHET 1/4, SLIM HEAD 72T

6954 T-HANDLE 1/4

6960 EXTENSION 1/4

6962 EXTENSION 1/4

6966 UNIVERSAL JOINT 1/4

7800SM-10 SOCKET 1/2

7800SM-11 SOCKET 1/2

7800SM-12 SOCKET 1/2

7800SM-13 SOCKET 1/2

7800SM-14 SOCKET 1/2

7800SM-15 SOCKET 1/2

7800SM-16 SOCKET 1/2

7800SM-17 SOCKET 1/2

7800SM-18 SOCKET 1/2

7800SM-19 SOCKET 1/2

7800SM-21 SOCKET 1/2

7800SM-22 SOCKET 1/2

7800SM-23 SOCKET 1/2

7800SM-24 SOCKET 1/2

7800SM-25 SOCKET 1/2

7800SM-26 SOCKET 1/2

7800SM-27 SOCKET 1/2

7800SM-28 SOCKET 1/2

7800SM-30 SOCKET 1/2

7800SM-32 SOCKET 1/2

8072IP ADJUSTABLE WRENCH 10

814-100 AWL

8150SL RATCHET 1/2, SLIM HEAD 72T

8154-1/2 T-HANDLE 1/2

8160-1/2 EXTENSION 1/2

8162-1/2 EXTENSION 1/2

8166-1/2 UNIVERSAL JOINT 1/2

8224IP SLIP JOINT PLIER 250 mm

MIX

3/3 MODULE MIX COMPOSITION



ERGO TOOL MANAGEMENT SYSTEM

**FF1A5008 - 24 pcs**

- 1-100-08-2-2 8 HAND.WITH HANDLE.CUT 2
- 1-160-08-2-2 8 SQUARE.WITH HANDLE.CUT 2
- 1-170-08-2-2 8 3 SQUARE.WITH HANDLE.CUT 2
- 1-210-08-2-2 8 1/2 ROUND.WITH HANDLE.CUT 2
- 1-230-08-2-2 8 ROUND.WITH HANDLE.CUT 2
- 1150D CALIPER, DIGITAL
- 1450D-ISO DOUBLE THREAD RESTORER
- 1547 FEELER GAUGE
- 3625N-40 PLASTIC HAMMER
- 3734-2 COTTER PIN PUNCH
- 3734-3 COTTER PIN PUNCH
- 3734-4 COTTER PIN PUNCH
- 3734-5 COTTER PIN PUNCH
- 3734-6 COTTER PIN PUNCH
- 3734-8 COTTER PIN PUNCH
- 3735-4-120 CENTRE PUNCH
- 3735-5-150 CENTRE PUNCH
- 3740-125 FLAT CHISEL
- 3740-150 FLAT CHISEL
- 38-20 TYRE LEVER
- 5515T TELESCOPIC MIRROR
- 9029 ADJUSTABLE WRENCH
- 9031 ADJUSTABLE WRENCH
- MTB-3-16 3M TAPE MEASURE 16mm

**FF1A5009 - 17 pcs**

- 2101S-160 SIDE CUTTER 160 mm
- 2223S-150 STRIPPING PLIER 150 mm
- 2250V-170 CABLE CUTTER 1000V 8D
- 2430S-200 LONG NOSE PLIER 200 mm
- 2628S-180 COMB PLIER 180 mm
- 8072V ADJUSTABLE WRENCH 1000V 10"
- BE-8220S SCREW.DR ERGO IEC 0.5 X 3.0 X 100
- BE-8040S SCREW.DR ERGO IEC 0.8 X 4.0 X 100
- BE-8340 SCREW.DR ERGO 0.8 X 4 X 25
- BE-8050S SCREW.DR ERGO IEC 1.0 X 5.5 X 125
- BE-8255S SCREW.DR ERGO IEC 1.2 X 6.5 X 150
- BE-8065S SCREW.DR ERGO IEC 1.2 X 8.0 X 175
- BE-8601 SCREW.DR ERGO PH1 X 25
- BE-8610S SCREW.DR ERGO IEC PH1 X 75
- BE-8620S SCREW.DR ERGO IEC PH2 X 100
- BE-8810S SCREW.DR ERGO IEC PZ1 X 75
- BE-8820S SCREW.DR ERGO IEC PZ2 X 100

**FF1A5010 - 22 pcs**

- 1-100-08-1-2 8" HAND WITH HANDLE, CUT 1
- 1-160-08-1-2 8" SQUARE WITH HANDLE, CUT 1
- 1-170-08-2-2 8" 3 SQUARE WITH HANDLE, CUT 2
- 1-210-08-1-2 8" 1/2 ROUND WITH HANDLE, CUT 1
- 1-230-08-1-2 8" ROUND WITH HANDLE, CUT 1
- 2101G-180IP SIDE CUTTER 180 mm
- 2427G-200IP SNIPER NOSE BENT 0 200 mm
- 2430G-200IP SNIPER NOSE CUTTING 200 mm
- 2628G-180IP COMB PLIER 180 mm
- 3733-2 DRIFT PUNCH
- 3733-4 DRIFT PUNCH
- 3733-6 DRIFT PUNCH
- 3734-2 COTTER PIN PUNCH
- 3734-3 COTTER PIN PUNCH
- 3734-4 COTTER PIN PUNCH
- 3734-5 COTTER PIN PUNCH
- 3734-6 COTTER PIN PUNCH
- 3734-8 COTTER PIN PUNCH
- 3735-4-120 CENTRE PUNCH
- 481-300 GERMAN DIN HAMMER
- 8069IP ADJUSTABLE WRENCH 4"
- 9031 ADJUSTABLE WRENCH

MIX

3/3 MODULE MIX COMPOSITION



ERGO TOOL MANAGEMENT SYSTEM

**FF1A5011 - 22 pcs**

- 1-476-04-3-2 SET 4" KEY FILES WITH HANDLES
- 1178-SCRIBE SCRIBER CARB TUNGSTEN
- 1547 FEELER GAUGE
- 2101G-160IP SIDE CUTTER 160 mm
- 2427G-160IP SNIPER NOSE BENT 160 mm
- 2430G-160IP SNIPER NOSE CUTTING 160 mm
- 3734-2 COTTER PIN PUNCH
- 3734-3 COTTER PIN PUNCH
- 3734-4 COTTER PIN PUNCH
- 3734-5 COTTER PIN PUNCH
- 3734-6 COTTER PIN PUNCH
- 3734-8 COTTER PIN PUNCH
- 3735-5-120 CENTRE PUNCH
- 481-500 GERMAN DIN-HAMMER
- BE-802DL SCREW.DR ERGO 0.5 X 3 X 75
- BE-804D SCREW.DR ERGO 0.8 X 4.0 X 100
- BE-815D SCREW.DR ERGO 1.0 X 6.5 X 100
- BE-825S SCREW.DR ERGO 1.2 X 6.5 X 150
- BE-8256 SCREW.DR ERGO 1.2 X 8.0 X 150
- BE-861D SCREW.DR ERGO PH1 X 75
- BE-862D SCREW.DR ERGO PH2 X 100
- MTB-3-16 3 m TAPE MEASURE 16 mm

**FF1A5012 - 13 pcs**

- 141 PIPE WRENCH
- 319 HACKSAW FRAME
- 3734-2 COTTER PIN PUNCH
- 3734-3 COTTER PIN PUNCH
- 3734-4 COTTER PIN PUNCH
- 3734-5 COTTER PIN PUNCH
- 3734-6 COTTER PIN PUNCH
- 479-08 BALL PEIN HAMMER
- 481-1000 GERMAN DIN-HAMMER
- 481-300 GERMAN DIN-HAMMER
- 782-U UTILITY WIRE BRUSH
- MTS-5-25 5 m TAPE 25 mm STAINLESS
- SQZ150003 UNIVERSAL KNIFE

MIX

3/3 MODULE MIX COMPOSITION



ERGO TOOL MANAGEMENT SYSTEM



FF1A5013- 41 pcs

111M-6 COMBINATION WRENCH

111M-7 COMBINATION WRENCH

111M-8 COMBINATION WRENCH

111M-9 COMBINATION WRENCH

111M-10 COMBINATION WRENCH

111M-11 COMBINATION WRENCH

111M-12 COMBINATION WRENCH

111M-13 COMBINATION WRENCH

111M-17 COMBINATION WRENCH

111M-19 COMBINATION WRENCH

111M-20 COMBINATION WRENCH

111M-22 COMBINATION WRENCH

111M-24 COMBINATION WRENCH

111M-27 COMBINATION WRENCH

111M-30 COMBINATION WRENCH

111M-32 COMBINATION WRENCH

6700SM-6 SOCKET 1/4

6700SM-7 SOCKET 1/4

6700SM-8 SOCKET 1/4

6700SM-9 SOCKET 1/4

6700SM-10 SOCKET 1/4

6700SM-11 SOCKET 1/4

6700SM-12 SOCKET 1/4

6700SM-13 SOCKET 1/4

6700SM-14 SOCKET 1/4

6950 RATCHET 1/4

6960 EXTENSION

6966 UNIVERSAL JOINT

7800SM-13 SOCKET 1/2

7800SM-17 SOCKET 1/2

7800SM-19 SOCKET 1/2

7800SM-22 SOCKET 1/2

7800SM-24 SOCKET 1/2

7800SM-27 SOCKET 1/2

7800SM-30 SOCKET 1/2

7800SM-32 SOCKET 1/2

8155-1/2 ONE HANDLE RATCHET 1/2"

8160-1/2 EXTENSION

8166-1/2 UNIVERSAL JOINT

SBS64 BAHCO T-HANDLE 1/4"

SBS86 BAHCO SLIDING T-HANDLE 1/2"

SCREWDRIVERS

3/3 MODULE SCREWDRIVERS COMPOSITION

- Slotted and Phillips
- Slotted, Phillips and Pozidriv
- Slotted, Phillips and Torx



FF1A1001 - 14 pcs

2509 FLEX. PICK UP
 2535F1 MAGNETIC PICK UP
 BE-8040 SCREW.DR ERGO 0.8 X 4.0 X 100
 BE-8210 SCREW.DR ERGO 0.4 X 2.5 X 75
 BE-8230 SCREW.DR ERGO 0.6 X 3.5 X 125
 BE-8252 SCREW.DR ERGO 1.2 X 6.5 X 150
 BE-8255 SCREW.DR ERGO 1.2 X 6.5 X 150
 BE-8350 SCREW.DR ERGO 1 X 5.5 X 25
 BE-8628 SCREW.DR ERGO PH1 X 100
 BE-8602 SCREW.DR ERGO PH2 X 25
 BE-8610L SCREW.DR ERGO PH1 X 200
 BE-8620L SCREW.DR ERGO PH2 X 200
 BE-8629 SCREW.DR ERGO PH2 X 125
 BE-8630 SCREW.DR ERGO PH3 X 150



FF1A1002 - 27 pcs

BE-8010S SCREW.DR ERGO JEO 0.4 X 2.5 X 75
 BE-8030 SCREW.DR ERGO 0.6 X 3.5 X 75
 BE-8040 SCREW.DR ERGO 0.8 X 4.0 X 100
 BE-8350 SCREW.DR ERGO 1 X 5.5 X 25
 BE-8242 SCREW.DR ERGO 1.0 X 5.5 X 150
 BE-8252 SCREW.DR ERGO 1.2 X 6.5 X 150
 BE-8257 SCREW.DR ERGO 1.2 X 8.0 X 175
 BE-8258 SCREW.DR ERGO 1.6 X 10.0 X 200
 BE-8880 SCREW.DR ERGO 2.0 X 12.0 X 200
 BE-8602 SCREW.DR ERGO PH2 X 25
 BE-8610 SCREW.DR ERGO PH1 X 75
 BE-8620 SCREW.DR ERGO PH2 X 100
 BE-8630 SCREW.DR ERGO PH3 X 150
 BE-8640 SCREW.DR ERGO PH4 X 200
 BE-8800 SCREW.DR ERGO PZ0 X 60
 BE-8802 SCREW.DR ERGO PZ2 X 25
 BE-8810 SCREW.DR ERGO PZ1 X 75
 BE-8820 SCREW.DR ERGO PZ2 X 100
 BE-9578 SCREW.DR SET HEX BLACK 9 PCS



FF1A1003 - 27 pcs

BE-8158 SCREW.DR ERGO 1.0 X 5.5 X 125
 BE-8159 SCREW.DR ERGO 1.2 X 6.5 X 150
 BE-8350 SCREW.DR ERGO 1 X 5.5 X 25
 BE-8870 SCREW.DR ERGO 1.6 X 10.0 X 175
 BE-8880 SCREW.DR ERGO 2.0 X 12.0 X 200
 BE-8610 SCREW.DR ERGO PH1 X 75
 BE-8602 SCREW.DR ERGO PH2 X 25
 BE-8630 SCREW.DR ERGO PH3 X 150
 BE-8908 SCREW.DR ERGO TX 8 X 60
 BE-8909 SCREW.DR ERGO TX 9 X 80
 BE-8910 SCREW.DR ERGO TX 10 X 95
 BE-8915 SCREW.DR ERGO TX 15 X 70
 BE-8920 SCREW.DR ERGO TX 20 X 80
 BE-8925 SCREW.DR ERGO TX 25 X 60
 BE-8927 SCREW.DR ERGO TX 27 X 100
 BE-8930 SCREW.DR ERGO TX 30 X 100
 BE-8940 SCREW.DR ERGO TX 40 X 130
 BE-9575 SCREW.DR SET TORX 8PCS
 BE-9578 SCREW.DR SET HEX BLACK 9PCS

SCREWDRIVERS

3/3 MODULE SCREWDRIVERS COMPOSITION

- T Handle
- Slotted, Phillips, Pozidriv and Torx
- Slotted, Phillips and Torx and Nut Drivers



FF1A1004 - 19 pcs

900T-050-150 HEXAGONAL T-HANDLE 5 X 150
 900T-020-100 HEXAGONAL T-HANDLE 2 X 100
 900T-025-100 HEXAGONAL T-HANDLE 2.5 X 100
 900T-030-100 HEXAGONAL T-HANDLE 3 X 100
 900T-040-150 HEXAGONAL T-HANDLE 4 X 150
 900T-060-200 HEXAGONAL T-HANDLE 6 X 200
 900T-080-200 HEXAGONAL T-HANDLE 8 X 200
 900T-100-200 HEXAGONAL T-HANDLE 10 X 200
 BE-9777B HEX KEY FOLDER HEX 2.5-10 BIMAT



FF1A1005 - 66 pcs

59S/31-1 BITS SET 31PCS PH,PZ,T,HEX,SL
 BE-8020 SCREW.DR ERGO 0.5 X 3.0 X 60
 BE-8240 SCREW.DR ERGO 0.8 X 4.0 X 175
 BE-8250 SCREW.DR ERGO 1.0 X 5.5 X 150
 BE-8255 SCREW.DR ERGO 1.2 X 6.5 X 150
 BE-8865 SCREW.DR ERGO 1.6 X 8.0 X 175
 BE-8602 SCREW.DR ERGO PH2 X 25
 BE-8611 SCREW.DR ERGO PH1 X 75
 BE-8621 SCREW.DR ERGO PH2 X 100
 BE-8630 SCREW.DR ERGO PH3 X 150
 BE-8800 SCREW.DR ERGO PZ0 X 60
 BE-8802 SCREW.DR ERGO PZ2 X 25
 BE-8811 SCREW.DR ERGO PZ1 X 75
 BE-8821 SCREW.DR ERGO PZ2 X 100
 BE-8830 SCREW.DR ERGO PZ3 X 150
 BE-8910 SCREW.DR ERGO TX 10 X 65
 BE-8915 SCREW.DR ERGO TX 15 X 70
 BE-8920 SCREW.DR ERGO TX 20 X 80
 BE-8925 SCREW.DR ERGO TX 25 X 80
 BE-9585 SCREW.DR SET TORX+MAG 8PCS
 BE-9678 SCREW.DR SET HEX BALL 9 PCS



FF1A1006 - 29 pcs

BE-7606 NUT DRIVER ERGO
 BE-7607 NUT DRIVER ERGO
 BE-8030 SCREW.DR ERGO 0.8 X 3.5 X 75
 BE-8040 SCREW.DR ERGO 0.8 X 4.0 X 100
 BE-8155 SCREW.DR ERGO 1.2 X 5.5 X 125
 BE-8350 SCREW.DR ERGO 1 X 5.5 X 25
 BE-8602 SCREW.DR ERGO PH2 X 25
 BE-8611 SCREW.DR ERGO PH1 X 75
 BE-8621 SCREW.DR ERGO PH2 X 100
 BE-8630 SCREW.DR ERGO PH3 X 150
 BE-8906 SCREW.DR ERGO TX 6 X 60
 BE-8907 SCREW.DR ERGO TX 7 X 55
 BE-8908 SCREW.DR ERGO TX 8 X 60
 BE-8909 SCREW.DR ERGO TX 9 X 60
 BE-8910 SCREW.DR ERGO TX 10 X 65
 BE-8915 SCREW.DR ERGO TX 15 X 70
 BE-8920 SCREW.DR ERGO TX 20 X 80
 BE-8925 SCREW.DR ERGO TX 25 X 80
 BE-8930 SCREW.DR ERGO TX 30 X 100
 BE-8940 SCREW.DR ERGO TX 40 X 130
 BE-9688 SCREW.DR SET HEX BALL+MAG 9PCS

SCREWDRIVERS

3/3 MODULE SCREWDRIVERS COMPOSITION

- Slotted, Phillips and Torx and Nut Drivers



FF1A1007 - 63 pcs

2510 WORKSHOP MIRROR

5468-112 TWEEZER 5468-112

5471F-145 TWEEZER 5471-F-145

59/S31 IMPACT BITS SET 31PCS

BE-8040 SCREW.DR ERGO 0,8 X 4,0 X 100

BE-8158 SCREW.DR ERGO 1,0 X 5,5 X 125

BE-8159 SCREW.DR ERGO 1,2 X 6,5 X 150

BE-8220 SCREW.DR ERGO 0,5 X 3,0 X 125

BE-8340 SCREW.DR ERGO 0,8 X 4 X 25

BE-8601 SCREW.DR ERGO PH1 X 25

BE-8628 SCREW.DR ERGO PH1 X 100

BE-8629 SCREW.DR ERGO PH2 X 125

BE-8865 SCREW.DR ERGO 1,6 X 8,0 X 175

BE-8906 SCREW.DR ERGO TX 6 X 60

BE-8907 SCREW.DR ERGO TX 7 X 65

BE-8908 SCREW.DR ERGO TX 8 X 60

BE-8909 SCREW.DR ERGO TX 9 X 60

BE-8910 SCREW.DR ERGO TX 10 X 65

BE-8915 SCREW.DR ERGO TX 15 X 70

BE-8920 SCREW.DR ERGO TX 20 X 80

BE-8925 SCREW.DR ERGO TX 25 X 80

BE-8930 SCREW.DR ERGO TX 30 X 100

BE-9770 SCREW.DR SET HEX 1,5-10

TL124-SA TWEEZER 124-SA

SOCKETS

3/3 MODULE SOCKETS AND ACCESSORIES COMPOSITION

• 3/4 sockets and accessories



ERGO TOOL MANAGEMENT SYSTEM



FF1A2301 - 26 pcs

8900DM-19 SOCKET 3/4

8900DM-22 SOCKET 3/4

8900DM-23 SOCKET 3/4

8900DM-24 SOCKET 3/4

8900DM-25 SOCKET 3/4

8900DM-26 SOCKET 3/4

8900DM-27 SOCKET 3/4

8900DM-28 SOCKET 3/4

8900DM-29 SOCKET 3/4

8900DM-30 SOCKET 3/4

8900DM-32 SOCKET 3/4

8900DM-33 SOCKET 3/4

8900DM-34 SOCKET 3/4

8900DM-36 SOCKET 3/4

8900DM-41 SOCKET 3/4

8900DM-46 SOCKET 3/4

8900DM-50 SOCKET 3/4

8900DM-55 SOCKET 3/4

8900DM-60 SOCKET 3/4

8952N/B HANDLE 3/4

8954 T-HANDLE 3/4

8954A SLIDING HEAD 3/4

8958A BREAKER BAR HEAD 3/4

8961 EXTENSION 3/4

8965 ADAPTOR 3/4

8966 UNIVERSAL JOINT 3/4

SOCKETS

3/3 MODULE SOCKETS AND ACCESSORIES COMPOSITION

▪ 1/4, 1/2, 3/8 sockets and accessories



ERGO TOOL MANAGEMENT SYSTEM



FF1A2501 - 83 pcs

6700SM-4 SOCKET 1/4

6700SM-5 SOCKET 1/4

6700SM-5.5 SOCKET 1/4

6700SM-6 SOCKET 1/4

6700SM-7 SOCKET 1/4

6700SM-8 SOCKET 1/4

6700SM-9 SOCKET 1/4

6700SM-10 SOCKET 1/4

6700SM-11 SOCKET 1/4

6700SM-12 SOCKET 1/4

6700SM-13 SOCKET 1/4

6700TORX-E8 SOCKET 1/4

6700TORX-E10 SOCKET 1/4

6709M-3 SOCKET 1/4

6709M-4 SOCKET 1/4

6709M-5 SOCKET 1/4

6709M-6 SOCKET 1/4

6709M-8 SOCKET 1/4

6709TORX-T8 SOCKET 1/4

6709TORX-T10 SOCKET 1/4

6709TORX-T15 SOCKET 1/4

6709TORX-T20 SOCKET 1/4

6709TORX-T25 SOCKET 1/4

6709TORX-T27 SOCKET 1/4

6709TORX-T30 SOCKET 1/4

6709TORX-T40 SOCKET 1/4

6950SL RATCHET 1/4, SLIM HEAD 72T

6954 T-HANDLE 1/4

6956 NUT DRIVER 1/4

6962 EXTENSION 1/4

6966 UNIVERSAL JOINT 1/4

7400SM-8 SOCKET 3/8

7400SM-9 SOCKET 3/8

7400SM-10 SOCKET 3/8

7400SM-11 SOCKET 3/8

7400SM-12 SOCKET 3/8

7400SM-13 SOCKET 3/8

7400SM-14 SOCKET 3/8

7400SM-15 SOCKET 3/8

7400SM-16 SOCKET 3/8

7400SM-17 SOCKET 3/8

7400SM-18 SOCKET 3/8

7400SM-19 SOCKET 3/8

7400SM-20 SOCKET 3/8

7400SM-21 SOCKET 3/8

7400SM-22 SOCKET 3/8

7400TORX-E8 SOCKET 3/8

7400TORX-E10 SOCKET 3/8

7400TORX-E12 SOCKET 3/8

7400TORX-E14 SOCKET 3/8

7750SL RATCHET 3/8, SLIM HEAD 72T

7754 T-HANDLE 3/8

7762 EXTENSION 3/8

7764 ADAPTOR 3/8

7765 ADAPTOR 3/8

7766 UNIVERSAL JOINT

7768 SMOOTH OPERATION U-JOINT-3/8

7800SM-12 SOCKET 1/2

7800SM-13 SOCKET 1/2

7800SM-17 SOCKET 1/2

7800SM-18 SOCKET 1/2

7800SM-19 SOCKET 1/2

7800SM-20 SOCKET 1/2

7800SM-21 SOCKET 1/2

7800SM-22 SOCKET 1/2

7800SM-24 SOCKET 1/2

7800SM-27 SOCKET 1/2

7800SM-30 SOCKET 1/2

7800SM-32 SOCKET 1/2

7809M-10 SOCKET 1/2

7809M-12 SOCKET 1/2

7809TORX-T20 SOCKET 1/2

7809TORX-T25 SOCKET 1/2

7809TORX-T40 SOCKET 1/2

7809TORX-T50 SOCKET 1/2

7809TORX-T55 SOCKET 1/2

8150SL RATCHET 1/2, SLIM HEAD 72T

8154-1/2 T-HANDLE 1/2

8162-1/2 EXTENSION 1/2

8164-1/2 ADAPTOR 1/2

8165-1/2 ADAPTOR 1/2

8166-1/2 UNIVERSAL JOINT 1/2

8964 ADAPTOR 1/2

WRENCHES

3/3 MODULE WRENCHES COMPOSITION

• Offset Combination and Ratcheting Wrenches



ERGO TOOL MANAGEMENT SYSTEM



FF1A3005 - 28 pcs

1952M-6 COMBINATION WRENCH

1952M-7 COMBINATION WRENCH

1952M-8 COMBINATION WRENCH

1952M-9 COMBINATION WRENCH

1952M-10 COMBINATION WRENCH

1952M-11 COMBINATION WRENCH

1952M-12 COMBINATION WRENCH

1952M-13 COMBINATION WRENCH

1952M-14 COMBINATION WRENCH

1952M-15 COMBINATION WRENCH

1952M-16 COMBINATION WRENCH

1952M-17 COMBINATION WRENCH

1952M-18 COMBINATION WRENCH

1952M-19 COMBINATION WRENCH

1952M-22 COMBINATION WRENCH

1RM-6 RATCHET WRENCH

1RM-7 RATCHET WRENCH

1RM-8 RATCHET WRENCH

1RM-9 RATCHET WRENCH

1RM-10 RATCHET WRENCH

1RM-11 RATCHET WRENCH

1RM-12 RATCHET WRENCH

1RM-13 RATCHET WRENCH

1RM-14 RATCHET WRENCH

1RM-17 RATCHET WRENCH

1RM-19 RATCHET WRENCH

1RM-22 RATCHET WRENCH

1RM-24 RATCHET WRENCH

PLIERS

3/3 MODULE WRENCHES COMPOSITION

- Pliers Mix including:
 - Side Cutting Pliers
 - Slip Joint Pliers
 - Circlip Pliers
 - Snipe Nose Pliers
 - Combination Pliers



FF1A4001 - 12 pcs

- 1520D POWER CUTTER 1520D
- 2101G-160IP SIDE CUTTER 160 mm
- 21HDG-200IP ERGO SIDE CUTTERHD 200 mm
- 2223G-150 STRIPPING PLIERS ERGO 150 mm
- 2421G-140IP FLAT NOSE PL LONG 140 mm
- 2421G-180IP FLAT NOSE PL 180 mm
- 2427G-200IP SNIPE NOSE BENT Ø 200 mm
- 2628G-180IP COMB PLIER 180 mm
- 2681 RIVET GUN
- 2951-140 CURVED JAWS CLAMP 140 mm
- 2951-300 GRIP WITH WIRE CUTTER 300 mm
- 8224IP SLIP JOINT PLIER 250 mm



FF1A4002 - 11 pcs

- 2101G-160IP SIDE CUTTER 160 mm
- 2430G-200IP SNIPE NOSE CUTTING 200 mm
- 2465D-200 CIRCLIPS PLIER 180 mm SPECIAL
- 2510 WORKSHOP MIRROR
- 2628G-160IP COMB PLIER 160 mm
- 2744 MULTI-PURPOSE SNIPE
- 2951-140 CURVED JAWS CLAMP 140 mm
- 2952-165 GRIP WITH EXTRA LONG NOSE
- 4560-210 LEVER SIDE CUTTING PLIERS 210 mm
- 527D-160 END CUTTER 160 mm
- 7224 SLIP JOINT PLIER 250 mm

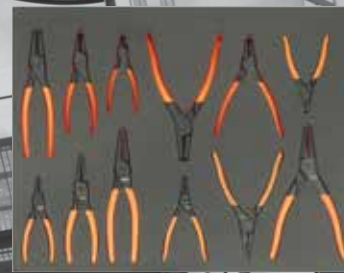

FF1A4003 - 12 pcs

- 2800-150 CIRCLIP PLIER 150 mm
- 2800-180 CIRCLIP PLIER 180 mm
- 2800-225 CIRCLIP PLIER 225 mm
- 2890-140 CIRCLIP PLIER 140 mm
- 2890-180 CIRCLIP PLIER 180 mm
- 2890-210 CIRCLIP PLIER 210 mm
- 2900-150 CIRCLIP PLIER 150 mm
- 2900-180 CIRCLIP PLIER 180 mm
- 2900-215 CIRCLIP PLIER 215 mm
- 2990-140 CIRCLIP PLIER 140 mm
- 2990-180 CIRCLIP PLIER 180 mm
- 2990-200 CIRCLIP PLIER 200 mm

GENERAL PURPOSE SMALL

1470K5FFMINI

GENERAL PURPOSE COMPOSITION WITH 5 DRAWER TROLLEY

- General Purpose Small composition in a 1470K5 trolley:
 - 1/2 socket drivers
 - Combination wrenches
 - Slotted, PH and TORX screwdrivers
 - Bits covering all profiles
 - Pliers: Side Cutters, combination, snipe nose, etc.
- Suitable for most of the applications
- It comes with 1470K5 trolley
- References for those foams are: FF1A5019 and FF1A1008



GENERAL PURPOSE SMALL - 105 pcs

111M COMBINATION WRENCH 6, 7, 8, 9, 10, 11, 12, 13, 14, 15, 16, 17, 18, 19, 20 mm

2101G-160IP SIDE CUTTER 160 mm

2430 G-160 IP SNIPE NOSE CUTTING 160 mm

2628 G-180IP COMBINATION PLIER 160 mm

59S/31-1 PZ1, PZ2 (x3), PZ3; PH1, PH2 (x3), PH3; PH2G (x2); T10, T15 (x3), T20 (x3), T25 (x2), T27 and T30. SL: 3, 4.5, 5.5mm; HEX: 3mm, 4, 5, 6mm, 1/4" Magnetic bit holder

7800DM SOCKET 1/2 8, 9, 10, 11, 12, 13, 14, 15, 16, 17, 18, 19, 20, 21, 22, 23, 24, 25, 26, 27, 28, 30, 32 mm

808050 RATCHETING BIT SCREWDRIVER

8154-1/2 T HANDLE 1/2

8155-1/2 RATCHET 1/2

8160-1/2 EXTENSION 125 mm

8162-1/2 EXTENSION 250 mm

8166-1/2 UNIVERSAL JOINT 1/2

8224 IP SLIP JOINT PLIER 250 mm

BE-8020L SCREWDRIVER ERGO 0.5 X 3 X 75

BE-8040 SCREWDRIVER ERGO 0.8 X 4.0 X 100

BE-8150 SCREWDRIVER ERGO 1.0 X 5.5 X 100

BE-8255 SCREWDRIVER ERGO 1.2 X 6.5 X 150

BE-8256 SCREWDRIVER ERGO 1.6 X 8.0 X 150

BE-8340 SCREWDRIVER ERGO 0.8 X 4 X 25

BE-8601 SCREWDRIVER ERGO PH1 X 25

BE-8610 SCREWDRIVER ERGO PH1 X 75

BE-8620 SCREWDRIVER ERGO PH2 X 100

BE-8925 SCREWDRIVER ERGO TORX 25 X 125

BE-8927 SCREWDRIVER ERGO TORX 27 X 125

BE-8930 SCREWDRIVER ERGO TORX 30 X 150

BE-8940 SCREWDRIVER ERGO TORX 40 X 150

BE-8945 SCREWDRIVER ERGO TORX 45 X 150

BE-9678 BLACK KEYS SETS FOR HEX SCREWS, LONG BALL END 1.5, 2, 2.5, 3, 4, 5, 6, 8, 10

GENERAL PURPOSE MEDIUM

1470K6FFMEDIUM

GENERAL PURPOSE COMPOSITION WITH 6 DRAWER TROLLEY

- General Purpose Medium composition in a 1470K6 trolley:
 - 1/4 and 1/2 socket drivers
 - Combination wrenches
 - Slotted, PH and TORX screwdrivers
 - Bits covering all profiles
 - Pliers: Side Cutters, combination, snipe nose, slip joint pliers, etc.
 - Including adjustable, T handle, hammers, hand hacksaws and its frame
- Suitable for most of the applications
- It comes with 1470K6 trolley
- References for those foams are: FF1A5020, FF1A5021, FF1A5022 and FF1A1009



GENERAL PURPOSE MEDIUM - 144 pcs

- 111M COMBINATION WRENCH: 6, 7, 8, 9, 10, 11, 12, 13, 14, 15, 16, 17, 18, 19, 20 mm
- 141 PIPE WRENCH
- 1419-MD MAGNETIC DISH
- 208-3906 HACKSAW FRAMES
- 2101G-160IP SIDE CUTTER 160 mm
- 2430 G-160 IP SNIPE NOSE CUTTING 160 mm
- 2444 CARPENTERS KNIFE
- 2509 FLEXIBLE PICK UP
- 2628 G-180IP COMBINATION PLIER 180 mm
- 268 MINI HACKSAW FRAMES
- 2744 MULTI-PURPOSE SNIPE
- 2951-180 GRIP 180 mm
- 2951-250 GRIP 250 mm
- 319-3906 HACKSAW FRAME
- 3625N-35 PLASTIC HAMMER
- 5515T TELESCOPIC MIRROR
- 59S/31-1 PZ1, PZ2 (x3), PZ3; PH1, PH2 (x3), PH3, PH2G (x2); T10, T15 (x3), T20 (x3), T25 (x2), T27, T30, SL: 3, 4, 5, 5.5 mm; HEX: 3 mm, 4, 5, 6 mm 1/4" Magnetic bit holder

- 6700SM SOCKET 1/4: 4, 4.5, 5, 5.5, 6, 7, 8, 9, 10, 11, 12, 13, 14 mm
- 6950 RATCHET 1/4 PEAR TYPE
- 6954 T-HANDLE
- 6956 SPINNER HANDLE 1/4
- 6960 EXTENSION 1/4 50 mm
- 6962 EXTENSION 1/4 150 mm
- 6966 UNIVERSAL JOINT 1/4
- 7800DM-10 SOCKET 1/2 8, 9, 10, 11, 12, 13, 14, 15, 16, 17, 18, 19, 20, 21, 22, 23, 24, 25, 26, 27, 28, 30, 32 mm
- 7805DM-10 1/2 DEEP SOCKET 10, 12, 13, 17, 19
- 8070 ADJUSTABLE WRENCH 6"
- 808050 RATCHETING BIT SCREWDRIVER
- 8154-1/2 T HANDLE 1/2
- 8155-1/2 RATCHET 1/2
- 8160-1/2 EXTENSION 125 mm
- 8162-1/2 EXTENSION 250 mm
- 8166-1/2 UNIVERSAL JOINT 1/2
- 8224 IP SLIP JOINT PLIER 250 mm
- 901T-010-100 TORX T-HANDLE 10 X 100
- 901T-015-150 TORX T-HANDLE 15 X 150

- 901T-020-150 TORX T-HANDLE 20 X 150
- 901T-025-150 TORX T-HANDLE 25 X 150
- 901T-027-150 TORX T-HANDLE 27 X 150
- 901T-030-200 TORX T-HANDLE 30 X 200
- 901T-040-200 TORX T-HANDLE 40 X 200
- 9031 ADJUSTABLE WRENCH
- 9072 P COMBINATION ADJUSTABLE WRENCH P 10"
- BE-8020L SCREWDRIVER ERGO 0.8 X 3 X 75
- BE-8040 SCREWDRIVER ERGO 0.8 X 4.0 X 100
- BE-8150 SCREWDRIVER ERGO 1.0 X 5.5 X 100
- BE-8255 SCREWDRIVER ERGO 1.2 X 6.5 X 150
- BE-8256 SCREWDRIVER ERGO 1.6 X 8.0 X 150
- BE-8340 SCREWDRIVER ERGO 0.8 X 4 X 25
- BE-8601 SCREWDRIVER ERGO PH1 X 25
- BE-8610 SCREWDRIVER ERGO PH1 X 75
- BE-8620 SCREWDRIVER ERGO PH2 X 100
- BE-9678 BLACK KEYS SETS FOR HEX SCREWS, LONG BALL END 1.6, 2, 2.5, 3, 4, 5, 6, 8, 10 mm
- MTB-5-25 5M TAPE MEASURE 25 mm

GENERAL PURPOSE LARGE

FF1ASET-MAX

GENERAL PURPOSE COMPOSITION 5 DRAWERS

- General Purpose Large composition trolley:
 - 1/4 and 1/2 socket drivers
 - Combination wrenches
 - Slotted, PH and TORX screwdrivers
 - Bits covering all profiles
 - Pliers: Side Cutters, combination, snipe nose, slip joint pliers, etc.
 - Including adjustable, T handle, hammers, hand hacksaws and its frame
- Suitable for most of the applications
- Available for all 26" trolleys
- References for those foams are: FF1A5023, FF1A5024, FF1A5025 and FF1A5026



GENERAL PURPOSE LARGE - 195 pcs

- 111M COMBINATION WRENCH 6, 7, 8, 9, 10, 11, 12, 13, 14, 15, 16, 17, 18, 19, 20 mm
- 141 PIPE WRENCH
- 1419-MD MAGNETIC DISH
- 1RM-10 RATCHET COMB.SPANNER 8, 9, 10, 11, 12, 13, 14, 15, 16, 17, 18, 19 mm
- 208-3906 HACKSAW FRAMES
- 2101G-160IP SIDE CUTTER 160 mm
- 2430 G-160 IP SNIPE NOSE CUTTING 160 mm
- 2444 CARPENTERS KNIFE
- 2509 FLEX. PICK UP
- 2628 G-180IP COMBINATION PLIER 180 mm
- 268 MINIHACKSAW FRAMES
- 2744 MULTI-PURPOSE SNIP
- 319-3906 HACKSAW FRAME
- 5515T TELESCOPIC MIRROR
- 59/S31 IMPACT-BITS SET 31 PCS
- 6700SM SOCKET 1/4 4, 4.5, 5, 5.5, 6, 7, 8, 9, 10, 11, 12, 13, 14 mm
- 6950 RATCHET 1/4, PEAR TYPE 72T
- 6954 T-HANDLE 1/4

- 6956 SPINNER HANDLE 1/4
- 6960 EXTENSION 1/4 50 mm
- 6962 EXTENSION 1/4 150 mm
- 6966 UNIVERSAL JOINT 1/4
- 7400SM-10 SOCKET 3/8 6, 7, 8, 9, 10, 11, 12, 13, 14, 15, 16, 17, 18, 19, 20, 21, 22 mm
- 7754 T-HANDLE 3/8
- 7755-3/8 RATCHET 3/8, ERGO
- 7760 EXTENSION 3/8, 75 mm
- 7761 EXTENSION 3/8, 125 mm
- 7762 EXTENSION 3/8, 250 mm
- 7766 UNIVERSAL JOINT 3/8
- 7800DM SOCKET 1/2 8, 9, 10, 11, 12, 13, 14, 15, 16, 17, 18, 19, 20, 21, 22, 23, 24, 25, 26, 27, 28, 29, 30, 32 mm
- 7805DM 1/2 DEEP SOCKET 10, 12, 13, 17, 19 mm
- 7809M SOCKET 1/2, HEX 5, 6, 7, 8, 9, 10, 12, 14, 17, 19 mm
- 7809M-10-140 SOCKET 1/2 HEX LONG
- 7809M-5-180 SOCKET 1/2 HEX LONG
- 7809M-6-140 SOCKET 1/2 HEX LONG
- 7809M-7-100 SOCKET 1/2 HEX LONG
- 7809M-8-120 SOCKET 1/2 HEX LONG
- 8070 ADJUSTABLE WRENCH 6"

- 808050 RATCHETING BIT SCREWDRIVER
- 8154-1/2 T HANDLE 1/2
- 8155-1/2 RATCHET 1/2
- 8160-1/2 EXTENSION 125 mm
- 8162-1/2 EXTENSION 250 mm
- 8166-1/2 UNIVERSAL JOINT 1/2
- 8224 IP SLIP JOINT PLIER 250 mm
- 9031 ADJUSTABLE WRENCH
- 9072 P-COMB ADJUSTABLE P 10"
- BE-8020L SCREWDRIVER ERGO 0.5 X 3 X 7BE-8040
- BE-8040 SCREWDRIVER ERGO 0.8 X 4.0 X 100
- BE-8150 SCREWDRIVER ERGO 1.0 X 5.5 X 100
- BE-8255 SCREWDRIVER ERGO 1.2 X 6.5 X 150
- BE-8256 SCREWDRIVER ERGO 1.6 X 8.0 X 150
- BE-8340 SCREWDRIVER ERGO 0.8 X 4 X 25
- BE-8601 SCREWDRIVER ERGO PH1 X 25
- BE-8610 SCREWDRIVER ERGO PH1 X 75
- BE-8620 SCREWDRIVER ERGO PH2 X 100
- BE-8670 BLACK KEYS SETS FOR HEX SCREWS, LONG BALL END 1.5, 2, 2.5, 3, 4, 5, 6, 8, 10 mm
- MTB-5-25 5M TAPE MEASURE 25 mm

APPLICATION COMPOSITIONS



ERGO TOOL MANAGEMENT SYSTEM

Aviation



Auto Repair



General Industry



Wind Power



Trades





TO OPEN
1. GRASP HANDLE OF FLAP
2. PULL HANDLE AND PULL LEVER NO. 1
3. PULL LEVER NO. 2 FULLY DOWN
4. GRASP HANDLE OF FLAP FOR ACCESS TO CARGO DOOR CONTROL PANEL
5. MAKE SURE THAT GREEN LIGHT IS ON
6. PRESS SELECTOR TO OPEN (UNTIL DOOR IS COMPLETELY OPEN)
7. MAKE SURE SELECTOR RETURNS TO NEUTRAL POSITION
8. LOCK FOLDING STRUT (SEE INSTRUCTIONS INSIDE)

TO CLOSE
1. UNLOCK FOLDING STRUT (SEE INSTRUCTIONS INSIDE)
2. OPEN FLAP FOR ACCESS TO CARGO DOOR CONTROL PANEL
3. PRESS SELECTOR TO CLOSE
4. UNTIL DOOR IS COMPLETELY CLOSED
5. PULL BACK LEVER NO. 2 IN ITS RECESS
6. PULL HANDLE OF LEVER NO. 1 AND FEED IT BACK IN ITS RECESS
7. MAKE SURE GREEN LIGHT IS OFF AND BLUE LIGHT IS ON
8. DOOR IS LOCKED IN CLOSED POSITION AND SELECTOR RETURNS TO NEUTRAL POSITION
9. CLOSE FLAP GIVING ACCESS TO CARGO DOOR CONTROL PANEL

CAUTION
IN CASE OF ACTUATOR FAILURE, DO NOT FORCE DOOR INTO OPEN OR CLOSE POSITION, BUT USE APPLICABLE PROCEDURE

ACCESS TO CARGO DOOR CONTROL PANEL

7

BAHCO





TOOL TROLLEY COMPOSITIONS - 114 PCS

- For general purpose
- Metric & inch
- 26 inches compositions. Equal to 3/3 dimensions from the modular system
- Its page is a composition but there is not mother code; you will have to order below codes + the tool trolley you wish
- Like this, you can also build up the aviation composition you want using the following eighteen 26 inches foam inserts



ERGO TOOL MANAGEMENT SYSTEM



FF1A01 - 77 pcs

- 6680DM SOCKET 1/4", AEROSPACE LONG SERIES
4, 5, 6, 7, 8, 9, 10, 11, 12, 13
- 6700SM SOCKET 1/4", AEROSPACE SHORT SERIES
4, 4.5, 5, 5.5, 6, 7, 8, 9, 10, 11, 12, 13
- 6972H BIT HOLDER 1/4"
- 6950SL REVERSIBLE RATCHET 1/4", SLIMHEAD
- 6954 T-HANDLE 1/4"
- 6956 SPINNER HANDLE 1/4"
- 6966 EXTENSION BAR 1/4" 50 mm
- 6961 EXTENSION BAR 1/4" 100 mm
- 6966 UNIVERSAL JOINT 1/4"
- 7805ZZ-21 SPARK PLUG SOCKET 1/2"
- 7800SM SOCKET 1/2", SHORT SERIES
10, 11, 12, 13, 14, 15, 16, 17, 18, 19, 22, 24, 27, 30, 32
- 8150SL REVERSIBLE RATCHET 1/2", SLIMHEAD
- 8154-1/2 SLIDING T-HANDLE 1/2"
- 8159-1/2 EXTENSION BAR 1/2" 75mm
- 8162-1/2 EXTENSION BAR 1/2" 250 mm
- 8166-1/2 UNIVERSAL JOINT 1/2"
- 7807H BIT HOLDER 1/2"
- 69S/22-1 22 PCS RUBBER BIT HOLDER
- PH. PZ, TORX®, SL
- PH1x100, PH2x125



FF1A02 - 19 pcs

- 6M OPEN END WRENCH
6x7, 8x9, 10x11, 12x13, 14x15, 16x17, 18x19, 21x22
- 111M COMBINATION WRENCH
6, 7, 8, 10, 12, 13, 14, 17, 19, 22
- 808050L RATCHETING BIT SCREWDRIVER WITH LEDS



FF1A03 - 18 pcs

- BE-9770 BLACK HEX KEYS SET, LONG BALL END, 9 PCS
1.5, 2, 2.5, 3, 4, 5, 6, 8, 10
- 2171G-160 SIDE CUTTER 160 mm
- 2678G-160 COMBINATION PLIER 160 mm
- 2971G-250 SLIP JOINT PLIER 250 mm
- 3734N DRIFT PUNCH 4x150, 6x150
- 481-400 DIN-HAMMER
- 306 HACKSAW FRAME AND SANDFLEX® BI-METAL BLADE
- 1-100-08-2 8" FLAT FILE, WITH HANDLE, SECOND
- MTG-5-19 5m TAPE MEASURE 19mm





TOOL TROLLEY COMPOSITIONS - 172 PCS

- For general purpose
- Metric & inch
- 26 inches compositions. Equal to 3/3 dimensions from the modular system
- Its page is a composition but there is not mother code; you will have to order below codes + the tool trolley you wish
- Like this, you can also build up the aviation composition you want using the following eighteen 26 inches foam inserts



FF1A04 - 30 pcs

S4RM FOUR SIZES RATCHETING WRENCH

8x11, 12x15, 16x19

111M COMBINATION WRENCH

6, 7, 8, 9, 10, 11, 12, 13, 14, 15, 16, 17, 18, 19, 21, 22, 24, 27, 30, 32

6M OPEN END WRENCH

6x7, 8x9, 10x11, 12x13, 14x15, 17x19

9071C ADJUSTABLE WRENCH CHROMED 8" ERGO™



FF1A05 - 104 pcs

BE-9678 BLACK KEYS SET, LONG BALL END 9 PCS

1.5, 2, 2.5, 3, 4, 5, 6, 8, 10

SBS60 SOCKET 1/4"

4, 4.5, 5, 6, 7, 8, 9, 10, 11, 12, 13, 14

SBS61 RATCHET 1/4"

SBS63 EXTENSION BARS 1/4" 50, 100, 150mm

SBS64 T-HANDLE 1/4"

SBS65 UNIVERSAL JOINT 1/4"

SBS67 BREAKER BAR 1/4"

SBS68 ADAPTOR 1/4" - 3/8"

6956 SPINNER HANDLE 1/4"

6972 CAT HOLE PUNCH

SBS80 SOCKET 1/2"

10, 11, 12, 13, 14, 16, 16, 17, 18, 18, 21, 22, 24, 27, 30, 32

8150SL REVERSIBLE RATCHET 1/2" SUMHEAD

8160-W EXTENSION BAR 1/2"

8159-1/2 EXTENSION BAR 1/2" 75mm

8162-1/2 EXTENSION BAR 1/2" 50mm

8166-1/2 UNIVERSAL JOINT 1/2"

8154 1/2 SLIDING T-HANDLE 1/2"

SBS90 ADAPTOR 1/2" - 3/8"

7809M SOCKET DRIVER 1/2" HEX

7809M SOCKET DRIVER 1/2" TORX

7809TORX SOCKET DRIVER 1/2" TORX

T20, T25, T27, T30, T40, T45, T50, T55, T60

808050 RATCHETING DR. SCREWDRIVER

59S/31-T BITS SET

31 PCS: PH, PZ, TORX®, HEX, SL



FF1A06 - 23 pcs

BE-8020L / BE-8040 SCREWDRIVERS ERGO™ SLOTTED

0.5X3X75, 0.8X4,0X100

BE-8150 / BE-8255 / BE- 8256 SCREWDRIVERS ERGO™

SLOTTED

1,0X5,5X100, 1,2X6,5X150, 1,6X8,0X150

BE-8350 SCREWDRIVER ERGO™ SLOTTED, STUBBY

1X5,5X25

BE-8601 SCREWDRIVER ERGO™ PHILLIPS, STUBBY

PH1X25

BE-8610 / BE-8620 SCREWDRIVERS ERGO™ PHILLIPS

PH1X75, PH2X100

BE-8910 / BE-8930 SCREWDRIVERS ERGO™ TORX®

T10X75, T15X100, T20X100, T25X125, T27X125, T30X150

MTB-3-16 TAPE MEASURE

311

2107 G-160IP SIDE CUTTER ERGO™

2427 G-200IP SNIPE NOSE PLIER, BENT ERGO™

2628 G-160IP COMBINATION PLIER ERGO™

8224 IP SLIP JOINT PLIER ERGO™

2951-180 GRIP WITH WIRE CUTTER

5515T-52 TELESCOPIC SWIVEL HEAD MIRROR

Ø 50 mm

2535L MAGNETIC PICK-UP WITH LIGHT



FF1A07 - 15 pcs

3734N DRIFT PUNCH 3, 5, 6

3735N-4-120 CENTRE PUNCH

3740-175 FLAT CHISEL

SQZ150003 SQUEEZE KNIFE

1-100-08-2-2 8" FLAT FILE,

WITH HANDLE, SECOND

1-210-08-2-2 8" HALF ROUND FILE,

WITH HANDLE, SECOND

1-230-08-2-2 8" ROUND FILE WITH HANDLE, SECOND

2744 MULTIPURPOSE SNIP 190 mm

317 HACKSAW FRAME AND SANDFLEX® BI-METAL BLADE

3625W-35 NYLON TIP HAMMER 35 mm

3745-150 CAPE CHISEL 150 mm

481-400 DIN-HAMMER

782-U UTILITY WIRE BRUSH



TOOL TROLLEY COMPOSITIONS -273 PCS

- For general purpose
- Metric & inch
- 26 inches compositions. Equal to 3/3 dimensions from the modular system
- Its page is a composition but there is not mother code; you will have to order below codes + the tool trolley you wish
- Like this, you can also build up the aviation composition you want using the following eighteen 26 inches foam inserts



FF1A08 - 138 pcs

6700SM SOCKET 1/4", AEROSPACE, SHORT SERIES

5.5, 6, 7, 8, 9, 10, 11, 12, 13

A6800DM SOCKET 1/4", AEROSPACE, LONG SERIES

5.5, 6, 7, 8, 9, 10, 11, 12, 13

6709M SOCKET DRIVER 1/4", HEX

3, 4, 5, 6, 8

6709PH SOCKET DRIVER 1/4", PH

1, 2, 3

6709TORX SOCKET DRIVER 1/4", TORX®

T8, T9, T10, T15, T20, T25, T27, T30, T40

6950SL REVERSIBLE RATCHET 1/4", SLIMHEAD

6951 T-HANDLE 1/4"

6956 SPINNER HANDLE 1/4"

6958 BREAKER BAR 1/4"

6960 / 6961 / 6962 / 6962L EXTENSION BARS 1/4"

50, 100, 150, 355 mm

6966 UNIVERSAL JOINT 1/4"

6972H BIT HOLDER 1/4"

7764 ADAPTOR F 3/8" - M 1/4"

7400SM SOCKET 3/8", SHORT SERIES

6, 7, 8, 9, 10, 11, 12, 13, 14, 15, 16, 17, 18, 19, 22

A7402DM SOCKET 3/8", AEROSPACE

10, 11, 12, 13, 14, 15, 16, 17, 18, 19

7409M SOCKET DRIVER 3/8", HEX

3, 4, 5, 6, 7, 8, 10

7409TORX SOCKET DRIVER 3/8", TORX®

T25, T27, T30, T40, T45, T50

7750SL RATCHET 3/8" SLIMHEAD

7754 T-HANDLE 3/8"

7758 BREAKER BAR 3/8"

7760 / 7761 / 7762

EXTENSION BARS 3/8"

75, 120, 250 mm

7766 UNIVERSAL JOINT 3/8"

7765 ADAPTOR F 1/4" - M 3/8"

8164-1/2 ADAPTOR F 3/8" - M 1/2"

7407H SOCKET HOLDER 3/8"

1/4" - 3/8"

7800SM SOCKET 1/2" SHORT SERIES 10, 11, 12, 13, 14, 15,

16, 17, 18, 19, 21, 22, 24, 27, 30, 33

7809M SOCKET DRIVER 1/2", HEX

5, 6, 7, 8, 10, 12, 14, 16, 18

7809TORX SOCKET DRIVER 1/2", TORX®

T20, T25, T27, T30, T40, T45, T50, T55, T60

8154-1/2 T-HANDLE 1/2"

8150SL RATCHET 1/2", SLIMHEAD

8160-1/2 EXTENSION BAR 1/2",

120 mm

8162-1/2 EXTENSION BAR 1/2"

250 mm

8166-1/2 UNIVERSAL JOINT 1/2"

8165-1/2 ADAPTOR F 1/2" - M 3/8"

8166-1/2 ADAPTOR F 1/2" - M 3/8"

8166-1/2 ADAPTOR F 1/2" - M 3/8"

8166-1/2 ADAPTOR F 1/2" - M 3/8"

8166-1/2 ADAPTOR F 1/2" - M 3/8"

8166-1/2 ADAPTOR F 1/2" - M 3/8"

8166-1/2 ADAPTOR F 1/2" - M 3/8"

8166-1/2 ADAPTOR F 1/2" - M 3/8"

8166-1/2 ADAPTOR F 1/2" - M 3/8"

8166-1/2 ADAPTOR F 1/2" - M 3/8"

8166-1/2 ADAPTOR F 1/2" - M 3/8"

8166-1/2 ADAPTOR F 1/2" - M 3/8"

8166-1/2 ADAPTOR F 1/2" - M 3/8"

8166-1/2 ADAPTOR F 1/2" - M 3/8"

8166-1/2 ADAPTOR F 1/2" - M 3/8"

8166-1/2 ADAPTOR F 1/2" - M 3/8"



FF1A09 - 34 pcs

111M COMBINATION WRENCH

6, 7, 8, 9, 10, 11, 12, 13, 14, 15, 16, 17, 18, 19, 21, 22, 24, 27, 30, 32

6M OPEN END WRENCH

6x7, 8x9, 10x11, 12x13, 14x15, 16x17, 18x19, 20x22, 24x27, 30x32

9071C ADJUSTABLE WRENCH CHROMED 8" ERGO™

1320RM RATCHET RING WRENCH

8x9, 10x11, 12x13



TOOL TROLLEY

COMPOSITIONS - 273 PCS

- For general purpose
- Metric & inch
- 26 inches compositions. Equal to 3/3 dimensions from the modular system
- Its page is a composition but there is not mother code; you will have to order below codes + the tool trolley you wish
- Like this, you can also build up the aviation composition you want using the following eighteen 26 inches foam inserts



FF1A10 - 66 pcs

- 808050P PISTOL HANDLE RATCHETING SCREWDRIVER
- 808050S RATCHETING SCREWDRIVER, STUBBY
- 59S/S31-1 BITS SET 31 PCS: PH, PZ, TORX®, HEX, SL
- 2047-0,8-4 OFFSET SCREWDRIVER 0,8X4X100
- 2047PR-1-2 DOUBLE OFFSET KEY FOR PHILLIPS SCREWS PH1 & 2
- BE-8020L SCREWDRIVER ERGO™, SLOTTED 0,6X3,5X75
- BE-8030 SCREWDRIVER ERGO™, SLOTTED 0,6X3,5X75
- BE-815 SCREWDRIVER ERGO™, SLOTTED 1,2X6,5X120
- BE-8260 SCREWDRIVER ERGO™ SLOTTED, HEX PROFILE & BOLSTER 1,6X8,0X175
- BE-8350 SCREWDRIVER ERGO™ SLOTTED, STUBBY 1X5,5X25
- BE-8601 / BE-8602 SCREWDRIVERS ERGO™, PHILLIPS, STUBBY PH1X25, PH2X25
- BE-8010 / BE-8050 SCREWDRIVERS ERGO™, PHILLIPS PH1X75, PH2X100, PH3X150
- BE-8910 / BE-8620 / BE-8940 SCREWDRIVERS ERGO™, TORX® T10X75, T15X100, T20X100, T25X125, T27X125, T30X150, T40X150
- BE-9770 BLACK HEX KEYS SET, LONG BALL END, 9 PCS HEX 1,5, 2, 2,5, 3, 4, 5, 6, 8, 10
- MTB-3-16 MEASURING TAPE 3 m
- 1177-SCRIBE OFFSET SCRIBER 230 mm
- 5515T-52 TELESCOPIC SWIVEL HEAD MIRROR Ø 50 mm
- 2820EF2 ELECTRICIAN'S KNIFE 200 mm



FF1A11 - 16 pcs

- 2101GC SIDE CUTTERS ERGO™ 125, 160 mm
- 21HDGC-200IP SIDE CUTTERS ERGO™ 200 mm
- 2427 GC-200IP LONG, ROUND NOSE CHROMED PLIER, ERGO™ 200 mm
- 2430 GC-200 IP SNIPE NOSE CHROMED PLIER, ERGO™ 200 mm
- 2628 GC-160IP COMBINATION CHROMED PLIER, ERGO™ 160 mm
- 8214CIP SLIP JOINT PLIER ERGO™
- 2951-250 GRIP WITH WIRE CUTTING
- 2952-100 GRIP WITH WIRE CUTTING
- 2928-180 PLIER FOR INTERNAL & EXTERNAL CIRCLIPS INT. 7-25 mm, EXT. 8-25 mm
- 2928-200 PLIER FOR INTERNAL & EXTERNAL CIRCLIPS INT. 10-51 mm, EXT. 7-51 mm
- 2928-250 PLIER FOR INTERNAL & EXTERNAL CIRCLIPS INT. 46-102 mm, EXT. 32-102 mm
- 2928-1 / 2928-4 SPARE TIPS FOR 2928 SERIES
- BFLA01 Q3 LED TORCH



FF1A12 - 19 pcs

- 481-300 / 481-500 DIN HAMMER 300, 500 mm
- 3625W-35 NYLON TIP HAMMER
- 8158-1/2 BREAKER BAR 380 mm
- 2509 FLEXIBLE PICK-UP TOOL 525 mm
- 2535F2 MAGNETIC PICK-UP TOOL 1 kg
- 3734 DRIFT PUNCHES Ø 3, 5, 8 mm
- 3735-4-120 CENTRE PUNCH 120 mm
- 3740-150 FLAT CHISEL 150 mm
- 3745-150 CAPE CHISEL 150 mm
- 1-100-06-1-2 6" FLAT FILE WITH HANDLE, BASTARD
- 1-100-06-2-2 6" FLAT FILE, WITH HANDLE, SECOND
- 1-160-06-1-2 6" SQUARE FILE, WITH HANDLE, BASTARD
- 1-210-06-1-2 6" HALF ROUND FILE, WITH HANDLE, BASTARD
- 1-230-06-1-2 6" ROUND FILE, WITH HANDLE, BASTARD
- FS-8 SCISSORS 7,5 cm BLADE
- 319 HACKSAW FRAME AND BI-METAL SANDFLEX® BLADE



TOOL TROLLEY COMPOSITIONS - 241 PCS

- For aviation mechanics
- Metric & inch
- 26 inches compositions. Equal to 3/3 dimensions from the modular system
- Its page is a composition but there is not mother code; you will have to order below codes + the tool trolley you wish
- Like this, you can also build up the aviation composition you want using the following eighteen 26 inches foam inserts



ERGO TOOL MANAGEMENT SYSTEM



FF1A13 - 82 pcs

A6800DZ SOCKETS 1/4" BI-HEX, AEROSPACE LONG SERIES
3/16", 7/32", 1/4", 9/32", 5/16", 11/32", 3/8", 7/16", 1/2", 9/16"

A6800DM SOCKETS 1/4", AEROSPACE LONG SERIES
4", 10"

6700SZ-5/32 SOCKET 1/4", SHORT SERIES

A6700DZ SOCKETS 1/4" BI-HEX, AEROSPACE SHORT SERIES
3/16", 7/32", 1/4", 9/32", 5/16", 11/32", 3/8", 7/16", 1/2", 9/16"

A6700DZ SWIVEL SOCKETS 1/4", BI-HEX, AEROSPACE
3/16", 7/32", 1/4", 9/32", 5/16", 11/32", 3/8", 7/16", 1/2", 9/16"

6966 UNIVERSAL JOINT 1/4"

6950SL REVERSIBLE RATCHET 1/4", SLIMHEAD

6958 BREAKER BAR 1/4"

6954 T-HANDLE 1/4"

6956 SPINNER HANDLE 1/4"

6960 / 6961 / 6962 / 6962L EXTENSION BARS 1/4"
50, 100, 150, 200 mm

A7400DZ SOCKET 3/8" BI-HEX, AEROSPACE SHORT SERIES
1/4", 5/16", 3/8", 7/16", 1/2", 17/32", 9/16", 19/32", 5/8", 11/16", 3/4", 13/16", 7/8"

A7402DZ SOCKETS 3/8", BI-HEX, LONG SERIES, AEROSPACE
1/4", 5/16", 3/8", 7/16", 1/2", 9/16", 5/8", 19/32", 11/16", 3/4", 13/16", 7/8"

7766 UNIVERSAL JOINT 3/8"

7750SL RATCHET 3/8", SLIMHEAD

7758 BREAKER BAR 3/8"

7754 T-HANDLE 3/8"

7752 SPEEDER 3/8"

7760 / 7761 / 7762 EXTENSION BARS 3/8"
75, 125, 250 mm

7764 ADAPTOR F 3/8" - M 1/4"

7765 ADAPTOR F 1/4" - M 1/4"

8165-1/2 ADAPTOR F 1/2" - M 3/8"

8164-1/2 ADAPTOR F 3/8" - M 1/2"

6972H BIT HOLDER 1/4"

7407H BIT HOLDER 3/8" 1/4" - 3/8"

7408H BIT HOLDER 3/8" - 5/16" - 3/8"

S610 S610A SOCKET SPARK PLUG 7/8"



FF1A15 - 12 pcs

6224CIP SLIP JOINT PLIER, ERGO™

2628 GC-160IP COMBINATION CHROMED PLIER, ERGO™
160 mm

2101GC SIDE CUTTING PLIER 125, 160 mm

2220 GC-200IP COMBINATION CHROMED PLIER, ERGO™
200 mm

2430 GC-200IP SNIPER NOSE PLIER 200 mm

2427 GC-200IP LONG ROUND NOSE CHROMED PLIER, ERGO™
200 mm

2421GC-180IP FLAT NOSE PLIER 180 mm

2650 SLIP JOINT, CONNECTOR PLIER

2951-180 GRIP & WELDING PLIER 180 mm

2865 WIRE TWISTING PLIER 224 mm

2855 D WIRE TWISTING PLIER 282 mm



FF1A14 - 43 pcs

111Z COMBINATION WRENCHES

1/4", 5/16", 3/8", 7/16", 1/2", 9/16", 5/8", 11/16", 3/4", 13/16", 7/8", 15/16", 1"

1952Z-11/32 COMBINATION WRENCH
11/32"

1320RZ RATCHETING RING WRENCHES

1/4X5/16", 5/16X11/32", 3/8X7/16", 1/2X9/16"

1950MZ-3/8 CROWFOOT ADJUSTABLE WRENCH 3/8"

8069 C IP ADJUSTABLE CHROMED WRENCH 4" 110X13 mm

9070C ADJUSTABLE WRENCH CHROMED 6" ERGO™
158x20 mm

1931Z LILIPUT DOUBLE OPEN-END WRENCHES

5/32", 3/16", 7/32", 1/4", 9/32", 5/16", 11/32", 3/8", 7/16", 1/2", 9/16"

6Z DOUBLE OPEN-END WRENCHES

1/4X5/16", 5/16X11/32", 3/8X7/16", 1/2X9/16", 19/32X11/16", 5/8X3/4", 25/32X13/16", 7/8X15/16", 15/16X1", 1X1.1/8", 1.1/16X1.1/4"



TOOL TROLLEY

COMPOSITIONS - 241 PCS

- For aviation mechanics
- Metric & inch
- 26 inches compositions. Equal to 3/3 dimensions from the modular system
- Its page is a composition but there is not mother code; you will have to order below codes + the tool trolley you wish
- Like this, you can also build up the aviation composition you want using the following eighteen 26 inches foam inserts



ERGO TOOL MANAGEMENT SYSTEM



FF1A16 - 18 pcs

- 5515T POCKET TELESCOPIC MIRROR
Ø 30 mm
- 5515T-52 TELESCOPIC SWIVEL HEAD MIRROR
Ø 50 mm
- 1544 FEELER GAUGE
- 1150-1/2H/P CALIPER
150 mm
- 1179-FLX-2 FLEXIBLE MEASURE ROD
300 mm
- MTB 3-16-E MEASURING TAPE
3 m
- 5471-1-145 GENERAL PURPOSE TWEEZER, STRAIGHT
145 mm
- 5516 GENERAL PURPOSE TWEEZER, ANGLE
150 mm
- 2744 MULTIPURPOSE SNIP
100 mm
- 2820EF2 ELECTRICIAN'S KNIFE WITH PLASTIC HANDLE
200 mm
- 2632 COMBINATION CUTTER PIN EXTRACTOR AND SPREADER
170 mm
- 1177-SCRIBE OFFSET SCRIBER 230 mm
- 3525HB THREE SQUARE MACHINIST'S SCRAPER
80/185 mm
- 269 UNIDIR PACK SAW 150 mm
- 2509 FLEXIBLE PICK-UP TOOL 525 mm
- 2535F2 MAGNETIC PICK-UP TOOL 1 kg
- KE18-01 CUTTER KNIFE ERGO™
- BFLA01 Q3 LED TORCH



FF1A17 - 61 pcs

- BE-9780 BLACK HEX KEYS SET,
LONG BALL END, 12 PCS
0.050", 1/16", 5/64", 3/16", 1/4", 5/8", 3/4", 7/8", 1", 1 1/8", 1 1/4", 1 1/2", 1 3/4", 1 7/8", 2", 2 1/4", 2 1/2", 2 3/4", 3", 3 1/4", 3 1/2", 3 3/4", 4", 4 1/4", 4 1/2", 4 3/4", 5", 5 1/4", 5 1/2", 5 3/4", 6", 6 1/4", 6 1/2", 6 3/4", 7", 7 1/4", 7 1/2", 7 3/4", 8", 8 1/4", 8 1/2", 8 3/4", 9", 9 1/4", 9 1/2", 9 3/4", 10", 10 1/4", 10 1/2", 10 3/4", 11", 11 1/4", 11 1/2", 11 3/4", 12", 12 1/4", 12 1/2", 12 3/4", 13", 13 1/4", 13 1/2", 13 3/4", 14", 14 1/4", 14 1/2", 14 3/4", 15", 15 1/4", 15 1/2", 15 3/4", 16", 16 1/4", 16 1/2", 16 3/4", 17", 17 1/4", 17 1/2", 17 3/4", 18", 18 1/4", 18 1/2", 18 3/4", 19", 19 1/4", 19 1/2", 19 3/4", 20", 20 1/4", 20 1/2", 20 3/4", 21", 21 1/4", 21 1/2", 21 3/4", 22", 22 1/4", 22 1/2", 22 3/4", 23", 23 1/4", 23 1/2", 23 3/4", 24", 24 1/4", 24 1/2", 24 3/4", 25", 25 1/4", 25 1/2", 25 3/4", 26", 26 1/4", 26 1/2", 26 3/4", 27", 27 1/4", 27 1/2", 27 3/4", 28", 28 1/4", 28 1/2", 28 3/4", 29", 29 1/4", 29 1/2", 29 3/4", 30", 30 1/4", 30 1/2", 30 3/4", 31", 31 1/4", 31 1/2", 31 3/4", 32", 32 1/4", 32 1/2", 32 3/4", 33", 33 1/4", 33 1/2", 33 3/4", 34", 34 1/4", 34 1/2", 34 3/4", 35", 35 1/4", 35 1/2", 35 3/4", 36", 36 1/4", 36 1/2", 36 3/4", 37", 37 1/4", 37 1/2", 37 3/4", 38", 38 1/4", 38 1/2", 38 3/4", 39", 39 1/4", 39 1/2", 39 3/4", 40", 40 1/4", 40 1/2", 40 3/4", 41", 41 1/4", 41 1/2", 41 3/4", 42", 42 1/4", 42 1/2", 42 3/4", 43", 43 1/4", 43 1/2", 43 3/4", 44", 44 1/4", 44 1/2", 44 3/4", 45", 45 1/4", 45 1/2", 45 3/4", 46", 46 1/4", 46 1/2", 46 3/4", 47", 47 1/4", 47 1/2", 47 3/4", 48", 48 1/4", 48 1/2", 48 3/4", 49", 49 1/4", 49 1/2", 49 3/4", 50", 50 1/4", 50 1/2", 50 3/4", 51", 51 1/4", 51 1/2", 51 3/4", 52", 52 1/4", 52 1/2", 52 3/4", 53", 53 1/4", 53 1/2", 53 3/4", 54", 54 1/4", 54 1/2", 54 3/4", 55", 55 1/4", 55 1/2", 55 3/4", 56", 56 1/4", 56 1/2", 56 3/4", 57", 57 1/4", 57 1/2", 57 3/4", 58", 58 1/4", 58 1/2", 58 3/4", 59", 59 1/4", 59 1/2", 59 3/4", 60", 60 1/4", 60 1/2", 60 3/4", 61", 61 1/4", 61 1/2", 61 3/4
- BE-8020L / BE-8220 SLOTTED SCREWDRIVERS, ERGO™
0.5x3x75 mm, 0.5x3x125 mm
- BE-8150 / BE-8155 SLOTTED SCREWDRIVERS, ERGO™
1x5x100 mm, 1.2x6x125 mm
- BE-8260 SCREWDRIVER ERGO™
SLOTTED
1.6X80X175
- BE-8610 / BE-8620 / BE-8630 PHILLIPS SCREWDRIVERS, ERGO™
PH1X75 mm, PH2X100 mm, PH2X150 mm
- BE-8690 / BE-8692 PHILLIPS SCREWDRIVERS, ERGO™
PH1X25 mm, PH2X25 mm
- 2047-1-5.5 DOUBLE OFFSET KEY FOR SLOTTED SCREWS
1X5.5X125 mm
- 2047PR-1-2 DOUBLE OFFSET KEY FOR PHILLIPS SCREWS
PH1 & 2
- 706-2 PRECISION SCREWDRIVERS SET FOR SLOTTED & PHILLIPS SCREWS
1.0X50, 1.2X50, 1.5X50, 1.8X50 mm, PH0, PH1
- 2058-BR BIT RATCHET 1/4"
- 59/S2R-A BITS SET FOR SLOTTED, PHILLIPS, TORX®, DIMENSION AND TORQUE SET HEAD SCREWS
28 PCS
- BE-8350 SCREWDRIVER ERGO™
SLOTTED, SUEB®
1X5.5X25
- 808050 RATCHETING BIT SCREWDRIVER



FF1A18 - 25 pcs

- 3736S/6 SET OF CHISELS
6 PCS
- 3734S/6 SET OF DRIFT PUNCHES,
6 PCS
2-8 x 150 Ø mm
- 481 DIN HAMMER
200, 500 gr
- 3625N-35 SUPERFLEX PLASTIC HAMMER
35 mm
- 782-U GENERAL PURPOSE UTILITY WIRE BRUSH
290 mm
- 1-476-04-3-2 4" HAND FILE SET,
WITH HANDLE: HAND, WARDING, SQUARE, THREE SQUARE,
HALF ROUND AND ROUND
- 2632/S4 SET INCLUDES AWL, HOT CHIS & PUNCHES - 4 PCS



HIGH PROTECTION RIGID CASES COMPOSITIONS

4750RCHDW01FF1

240 PCS

- Aviation Mechanics, especially for mobile application
- Hardware: 4750RCHDW01, Heavy Duty Rigid Case with wheels
- Metric & inch
- Sizes: 1/4; 3/8



FF2B01 - 61 pcs

A6700DZ SOCKETS 1/4", BI-HEX, AEROSPACE SHORT SERIES
3/16", 7/32", 1/4", 9/32", 5/16", 11/32", 3/8", 7/16", 1/2", 9/16"

A6800DZ SOCKETS 1/4", BI-HEX, AEROSPACE LONG SERIES
3/16", 7/32", 1/4", 9/32", 5/16", 11/32", 3/8", 7/16", 1/2", 9/16"

6950SL REVERSIBLE RATCHET 1/4", SLIMHEAD

6954 T-HANDLE 1/4"

6956 SPINNER HANDLE 1/4"

6958 BREAKER BAR 1/4"

6960 / 6961 EXTENSION BARS 1/4"

50, 100 mm

6962L EXTENSION BAR 1/4"

385 mm

6966 UNIVERSAL JOINT 1/4"

7764 ADAPTOR F 3/8" - M 1/4"

7765 ADAPTOR F 1/4" - M 3/8"

6972H BIT HOLDER 1/4"

A7402DZ SOCKETS 3/8", BI-HEX, LONG SERIES, AEROSPACE

1/4", 5/16", 3/8", 7/16", 1/2", 9/16", 5/8", 11/16", 3/4", 13/16", 7/8", 1"

A7400DZ SOCKETS 3/8", AEROSPACE SHORT SERIES

1/4", 5/16", 3/8", 7/16", 1/2", 9/16", 5/8", 11/16", 3/4", 13/16", 7/8", 1"

7750SL RATCHET 3/8" SLIMHEAD

7754 T-HANDLE 3/8"

7760 / 7761 / 7762 EXTENSION BARS 3/8"

75, 125, 250 mm

7766 UNIVERSAL JOINT 3/8"

8164-172 ADAPTOR F 3/8" - M 1/2"

7407H SOCKET HOLDER 3/8"

1/4" - 3/8"

S6106KA SPARK PLUG SOCKET 7/8"



FF2B02 - 69 pcs

A6700DM SOCKETS 1/4", BI-HEX, AEROSPACE SHORT SERIES
5.5, 6, 7, 8, 9, 10, 11, 12, 13, 14

A6700DM SOCKETS 1/4", AEROSPACE LONG SERIES
4.5, 5.5, 6, 7, 8, 9, 10, 11, 12, 13, 14

A7400DM SOCKETS 3/8", BI-HEX, AEROSPACE SHORT SERIES
10, 11, 12, 13, 14, 15, 16, 17, 18, 19

A7402DM SOCKETS 3/8", BI-HEX, LONG SERIES, AEROSPACE
10, 11, 12, 13, 14, 15, 16, 17, 18, 19

4020MM LILIPUT COMBINATION WRENCH
5, 5.5 mm

111M COMBINATION WRENCHES
6, 7, 8, 9, 10, 11, 12, 13, 14, 15, 16, 17, 18, 19, 22, 24

BE-9780 BLACK HEX KEYS SET, LONG BALL END, 12 PCS
1.5, 2, 2.5, 3, 4, 5, 6, 8, 10 mm



FF2B03 - 44 pcs

A6710DZ SWIVEL SOCKETS 1/4", BI-HEX, AEROSPACE
3/16", 7/32", 1/4", 9/32", 5/16", 11/32", 3/8", 7/16", 1/2", 9/16"

A6710DM-7 SWIVEL SOCKETS 1/4", BI-HEX, AEROSPACE
7 mm

2058-BR BIT-RATCHET 1/4"

1950MZ-3/8 CROWFOOT ADJUSTABLE WRENCH 3/8"

BE-9780 BLACK HEX KEYS SET, LONG BALL END, 12 PCS

0.050", 1/16", 5/64", 3/32", 7/64", 1/8", 9/64", 5/32", 3/16", 7/32", 1/4", 5/16"

111Z COMBINATION WRENCHES

7", 5/16", 3/8", 7/16", 1/2", 9/16", 5/8", 11/16", 3/4", 13/16", 7/8", 1"

1320RZ RATCHETING RING WRENCHES

1/4X5/16", 5/16X11/32", 3/8X7/16", 1/2X9/16"

1931Z LILIPUT DOUBLE OPEN-END WRENCHES

3/16", 7/32", 1/4"



HIGH PROTECTION RIGID CASE COMPOSITIONS

4750RCHDW01FF1

240 PCS

- Aviation Mechanics, especially for mobile application
- Hardware: 4750RCHDW01. Heavy Duty Rigid Case with wheels
- Metric & inch
- Sizes: 1/4; 3/8



FF2B04 - 45 pcs

- 9076C ADJUSTABLE WRENCH CHROMED 6" ERGO™
- 158x20 mm
- 2509 FLEXIBLE PICK-UP TOOL
- 625 mm
- 808050 RATCHETING BIT SCREWDRIVER
- 59/S28-4 BITS SET FOR SLOTTED, PHILLIPS, TORX®
- HEXAGON AND TORQ-SET® HEAD SCREWS
- 28 PCS
- 701 PRECISION SCREWDRIVERS FOR PHILLIPS HEAD SCREWS
- PH00X50, PH0X50
- 700 PRECISION SCREWDRIVERS HEAD SCREWS, SLOTTED
- 1.5X50, 1X50
- BE-8020L / BE-8040 SCREWDRIVERS ERGO™, SLOTTED
- 0.5X3X75, 0.8X4.0X100
- BE-8150 / BE-8255 SCREWDRIVERS ERGO™, SLOTTED
- 1.0X5.5X100, 1.2X6.5X15
- BE-8610 / BE-8620 SCREWDRIVERS ERGO™, PHILLIPS
- PH1X75, PH2X100
- BE-8080-10 SCREWDRIVER
- TORQ-SET, ERGO™
- 10X100
- 2535F2 MAGNETIC PICK-UP TOOL
- 1 kg
- 5516 GENERAL PURPOSE TWEEZER
- 135 mm
- 1544 FEELER GAUGE



FF2B05 - 15 pcs

- 5515T-52 TELESCOPIC SWIVEL HEAD MIRROR
- Ø 50mm
- 2650 SLIP JOINT OPEN END WRENCH
- 2838 WIRE TWISTING PLIER
- 224 mm
- 4130 SIDE CUTTING PLIER, ERGO™
- 120 mm
- 2101GC SIDE CUTTING PLIER, ERGO™
- 125 mm, 160mm
- 2427-30-200IP LONG, ROUND NOSE CHROMED PLIER, ERGO™
- 160 mm
- 2628-30-160IP COMBINATION PLIER, CHROMED, ERGO™
- 160 mm
- 0724701-30-160MM COMBINATION PLIER, ERGO™
- 160 mm
- 4830 FINE MECHANICAL SLIP JOINT PLIER, ERGO™
- 2820EF2 ELECTRICIAN'S KNIFE
- 200 mm
- BELA01 03 LED-TORCH
- MTB-3-16-E MEASURING TAPE
- 3 m
- 1130-172H/P CALIPER
- 160 mm
- 1179-FLX-2 FLEXIBLE MEASURING ROD
- 380 mm



FF2B06 - 6 pcs

- 3625N-32 PLASTIC HAMMER
- 481-300 DIN HAMMER
- 300 mm
- 3734 DRIFT PUNCHES
- Ø 3, 5, 8 mm
- 3735-5-120 CENTRE PUNCH
- 5X120 mm



HIGH PROTECTION RIGID CASES COMPOSITIONS

4750RCHDW01FF2

159 PCS

- Aviation Mechanics, especially for mobile application
- Hardware: 4750RCHDW01, Heavy Duty Rigid Case with wheels
- Suitable for all airplanes
- Inch
- Sizes: 1/4; 3/8



FF2B07 - 62 pcs

A6700DZ SOCKET 1/4" BI-HEX, AEROSPACE

3/16", 7/32", 1/4", 9/32", 5/16", 3/8", 11/32", 7/16", 1/2", 9/16"

A6710DZ SWIVEL SOCKETS 1/4", BI-HEX, AEROSPACE

5/16", 3/8", 7/16"

A6800DZ SOCKETS 1/4" BI-HEX, AEROSPACE

3/16", 7/32", 1/4", 9/32", 5/16", 3/8", 11/32", 7/16", 1/2", 9/16"

A7400DZ SOCKETS 3/8" BI-HEX, SHORT SERIES, AEROSPACE

3/8", 7/16", 1/2", 9/16", 19/32", 5/8", 11/16", 3/4", 13/16", 7/8"

A7490DZ SOCKETS 3/8" BI-HEX, LONG SERIES, AEROSPACE

3/8", 7/16", 1/2", 9/16", 19/32", 5/8", 11/16", 3/4", 13/16", 7/8"

6950SL REVERSIBLE RATCHET 1/4" SLIMHEAD

6954 T-HANDLE 1/4"

6950 SPINNER HANDLE 1/4"

6960 / 6962 EXTENSION BARS 1/4" 50, 150 mm

6962L EXTENSION BAR 1/4" 355 mm

6966 UNIVERSAL JOINT 1/4"

6972H BIT HOLDER 1/4"

7407H BIT HOLDER 3/8" 1/4" - 3/8"

7408H BIT HOLDER 3/8" 5/16" - 3/8"

7752 SPEEDER 3/8"

7750SL RATCHET 3/8" SLIMHEAD

7760 / 7762 EXTENSION BARS 3/8" 75, 125, 250 mm

7764 ADAPTOR F 3/8" - M 1/4"

7765 ADAPTOR F 1/4" - M 3/8"

7766 UNIVERSAL JOINT 3/8"

8164-1/2 ADAPTOR F 3/8" - M 1/2"

7407H BIT HOLDER 3/8" 1/4" - 3/8"

7408H BIT HOLDER 3/8" 5/16" - 3/8"

7752 SPEEDER 3/8"

7750SL RATCHET 3/8" SLIMHEAD

7760 / 7762 EXTENSION BARS 3/8" 75, 125, 250 mm

7764 ADAPTOR F 3/8" - M 1/4"

7765 ADAPTOR F 1/4" - M 3/8"

7766 UNIVERSAL JOINT 3/8"

8164-1/2 ADAPTOR F 3/8" - M 1/2"

7760 / 7762 EXTENSION BARS 3/8"

75, 125, 250 mm

7764 ADAPTOR F 3/8" - M 1/4"

7765 ADAPTOR F 1/4" - M 3/8"

7766 UNIVERSAL JOINT 3/8"

8164-1/2 ADAPTOR F 3/8" - M 1/2"



FF2B08 - 25 PCS

111Z COMBINATION WRENCHES

1/4", 5/16", 3/8", 7/16", 1/2", 9/16", 5/8", 11/16", 3/4", 7/8", 1"

1320RZ RATCHETING RING WRENCHES

1/4X5/16", 5/16X11/32", 3/8X7/16", 1/2X9/16"

1931Z LILIPUT DOUBLE OPEN-END WRENCHES

3/16", 7/32", 1/4"

9031 C ADJUSTABLE WRENCH 8", ERGO™, CHROMED

218x38 mm

208 MINI HACKSAW FRAMES

250 mm

1-100-04-2-2 4" FLAT FILE, ERGO™, WITH HANDLE,

SECOND 4"

1-230-04-2-2 4" ROUND HAND FILE, ERGO™, WITH HANDLE,

SECOND 4"

2056-BR BIT RATCHET 1/4"

1177-SCRIBE OFFSET SCRIBER 230mm

1950MZ-3/8 CROWFOOT ADJUSTABLE WRENCH 3/8"



HIGH PROTECTION RIGID CASE COMPOSITIONS

4750RCHDW01FF2

159 PCS

- Aviation Mechanics, especially for mobile application
- Hardware: 4750RCHDW01. Heavy Duty Rigid Case with wheels
- Suitable for all airplanes
- Inch
- Sizes: 1/4; 3/8



FF2B09 - 56 PCS

BE-8210 / BE-8040 SCREWDRIVERS ERGO™ SLOTTED

0.4X2, 5X75, 0.8X4, 0X100 mm

BE-8150 SCREWDRIVERS ERGO™ SLOTTED

1.0X5, 5X100 mm

BE-8260 SCREWDRIVER ERGO™

SLOTTED, HEX PROFILE & BOLSTER

1.6X8, 0X175

BE-8600 / BE-8620 SCREWDRIVERS ERGO™ PHILLIPS

PH0X60, PH1X75, PH2X100

BE-8780 BLACK HEX KEYS SET,

LONG BALL END, 12 PCS

0.05", 1/16", 5/64", 3/32", 7/64", 1/8", 9/64", 5/32", 3/16",

7/32", 1/4", 5/16"

2047PR-1-2 DOUBLE OFFSET KEY FOR PHILLIPS SCREWS

PH1 & 2

2047-1-5.5 DOUBLE OFFSET KEY FOR SLOTTED SCREWS

1X5, 5X125 mm

BFLA01 Q3 LED-TORCH

59/S28-4 BITS SET FOR SLOTTED, PHILLIPS, TORX™

HEXAGON AND TORQ-SET™ HEAD SCREWS

28 PCS

808050 RATCHETING BIT SCREWDRIVER

MTB-3-16-E MEASURING TAPE

3 m

1170 FLY-E FLEXIBLE MEASUR. ROD, 200

5513T-3Z TELESCOPIC SWIVEL HEAD MIRROR

Ø 50 mm

2509 FLEXIBLE PICK-UP TOOL

525 mm

2535F2 MAGNETIC PICK-UP TOOL

1 kg



FF2B10 - 9 PCS

2101GC-160IP SIDE CUTTING PLIER, ERGO™

160 mm

2650 SLIP JOINT GRIPPING WIRE PLEIER

160 mm

2628 GC-160IP COMBINATION CHROMED PLIER, ERGO™

160 mm

2427 GC-200IP LONG, ROUND NOSE CHROMED PLIER,

ERGO™

200 mm

2430 GC-200 IP SNIPER NOSE CHROMED PLIER, ERGO™

200 mm

2855 WIRE TWISTING PLIER

224 mm

2744 MULTI-PURPOSE

160 mm

32240H 2-STEP JOINT PLEIER ERGO™

160 mm

2979 D-180 FLA. NOSE CUT P L I E R

180/8 - 13 mm



FF2B11 - 7 PCS

481-300 DIN HAMMER

300 mm

3625N-32 PLASTIC HAMMER

300 mm

3734 DRIFT PUNCHES

Ø 2, 3, 4, 5 mm

2632 COMBINATION COTTER PIN EXTRACTOR AND

SPREADER

170 mm



HIGH PROTECTION RIGID CASES COMPOSITIONS

■ 4750RCHDW01FF3

194 PCS

- For general purpose
- Hardware: 4750RCHDW01, Heavy Duty Rigid Case with wheels
- Metric
- Sizes: 1/4", 3/8"



FF2B12 - 92 pcs

6700SM SOCKET 1/4", AEROSPACE, SHORT SERIES

5.5, 6, 7, 8, 9, 10, 11, 12, 13

A6800DM SOCKET 1/4", AEROSPACE, LONG SERIES

5.5, 6, 7, 8, 9, 10, 11, 12, 13

6709M SOCKET DRIVER 1/4", HEX

3, 4, 5, 6, 8

6709PH SOCKET DRIVER 1/4", PH

1, 2, 3

6709TORX SOCKET DRIVER 1/4", TORX®

T8, T9, T10, T15, T20, T25, T27, T30, T40

6950SL REVERSIBLE RATCHET 1/4", SLIMHEAD

6954 T-HANDLE 1/4"

6956 SPINNER HANDLE 1/4"

6958 BREAKER BAR 1/4"

6960 / 6962 EXTENSION BARS 1/4"

50, 100, 150 mm

6962L EXTENSION BAR 1/4"

355 mm

6966 UNIVERSAL JOINT 1/4"

6972H BIT HOLDER 1/4"

7764 ADAPTOR F 3/8" - M 1/4"

7400SM SOCKET 3/8", AEROSPACE, SHORT SERIES 6, 7, 8, 9, 10, 11, 12,

13, 14, 15, 16, 17, 18, 19, 22

A7402DM SOCKET 3/8", AEROSPACE

10, 11, 12, 13, 14, 15, 16, 17, 18, 19

7409M SOCKET DRIVER 3/8" HEX

3, 4, 5, 6, 7, 8, 10

7409TORX SOCKET DRIVER 3/8", TORX®

T25, T27, T30, T40, T45, T50

7750SL RATCHET 3/8" SLIMHEAD

7760 / 7762 EXTENSION BARS 3/8"

75, 120, 150 mm

7766 UNIVERSAL JOINT 3/8"

7765 ADAPTOR F 1/4" - M 3/8"

8164-1/2 ADAPTOR F 3/8" - M 1/2"

7407H SOCKET HOLDER 3/8"

1/4" - 3/8"



FF2B13 - 39 pcs

111M COMBINATION WRENCH

6, 7, 8, 9, 10, 11, 12, 13, 14, 15, 16, 17, 18, 19, 21, 22

6M OPEN END WRENCH

6x7, 8x9, 10x11, 12x13, 14x15, 16x17, 18x19, 20x22

BE-9770 BLACK HEX KEYS SET, LONG BALL END, 9 PCS

1.5, 2, 2.5, 3, 4, 5, 6, 8, 10 mm

9070C ADJUSTABLE WRENCH CHROMED 6" ERGO™

158x20 mm

1177-SCRIBE OFFSET SCRIBER

230 mm

2535F2 MAGNETIC PICK UP

1 kg

7758 BREAKER BAR

BFLA01 Q3 LED-TORCH

7754 T-HANDLE 3/8"



HIGH PROTECTION RIGID CASE COMPOSITIONS

4750RCHDW01FF3

194 PCS

- For general purpose
- Hardware: 4750RCHDW01. Heavy Duty Rigid Case with wheels
- Metric
- Sizes: 1/4", 3/8"



FF2B14 - 48 pcs

- 808050P PISTOL HANDLE RATCHETING SCREWDRIVER
- 808050S RATCHETING SCREWDRIVER, STUBBY
- 59S/31-1 BITS SET
- 31 PCS: PH, PZ, TORX®, HEX, SL
- 2047-0.8-4 OFFSET SCREWDRIVER
- 0.8X4X100
- 2047PR-1-2 DOUBLE OFFSET KEY FOR PHILLIPS SCREWS
- PH1 & 2
- BE-8020L SCREWDRIVER ERGO™, SLOTTED
- 0.5X3X75
- BE-8030 SCREWDRIVER ERGO™
- SLOTTED
- 0.8X3.5X75
- BE-8155 SCREWDRIVER ERGO™
- SLOTTED
- 1.2X6.5X125
- BE-8200 SCREWDRIVER ERGO
- SLOTTED, HEX PROFILE & BOLSTER
- 1.6X8.0X175
- BE-8350 SCREWDRIVER ERGO™
- SLOTTED, STUBBY
- 1X5.5X25
- BE-8601 / BE-8602 SCREWDRIVERS ERGO™, PHILLIPS
- STUBBY
- PH1X25, PH2X25
- BE-8610 / BE-8612 SCREWDRIVERS ERGO™, PHILLIPS
- PH1X75, PH2X100, PH3X150
- 2058-BR BIT RATCHET 1/4"
- 1544 FEELER GAUGE
- 2509 FLEXIBLE PICK-UP TOOL
- 525 mm



FF2B15 - 9 pcs

- MTB-3-16-E MEASURING TAPE ENGLISH
- 3 m
- 2101GC-160IP SIDE GRIP COMBINATION PLIER, ERGO™
- 160 mm
- 2427 GC-200IP LONG, ROUND NOSE CHROMED PLIER, ERGO™
- 200 mm
- 2430 GC-200 IP SNIPE NOSE CHROMED PLIER, ERGO™
- 200 mm
- 2628 GC-160IP COMBINATION CHROMED PLIER, ERGO™
- 160 mm
- 8224CIP SLIP JOINT PLIER, ERGO™
- 1150-1/2H/P DN 1150
- 1150 mm
- 8616-1/2H/SC DN 1150
- Ø 50 mm
- 2020E2 ELECTRICIAN'S KNIFE



FF2B16 - 6 pcs

- 481-300 DIN HAMMER
- 300 mm
- 3625W-35 NYLON TIP HAMMER
- 3734 DRIFT PUNCHES
- Ø 3, 5, 8 mm
- 3735-4-120 CENTRE PUNCH
- 120 mm



HIGH PROTECTION RIGID CASES COMPOSITIONS

4750RCHD01FF1

159 PCS

- Aviation Mechanics, especially for mobile application
- Hardware: 4750RCHD01: Heavy Duty Rigid Case without wheels
- Suitable for all airplanes
- Inch
- Sizes: 1/4; 3/8

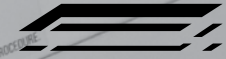

ERGO TOOL MANAGEMENT SYSTEM



FF2A07 - 64 pcs

A6700DZ SOCKET 1/4" BI-HEX, AEROSPACE SHORT SERIES

3/16", 7/32", 1/4", 9/32", 5/16", 3/8", 11/32", 7/16", 1/2", 9/16"

A6710DZ SWIVEL SOCKETS 1/4"

BI-HEX, AEROSPACE

1/4", 5/16", 3/8", 7/16"

A6800DZ SOCKETS 1/4" BI-HEX, LONG, AEROSPACE

3/16", 7/32", 1/4", 9/32", 5/16", 3/8", 11/32", 7/16", 1/2", 9/16"

A7400DZ SOCKETS 3/8" BI-HEX, SHORT SERIES, AEROSPACE

3/8", 7/16", 1/2", 9/16", 19/32", 5/8", 11/16", 3/4", 13/16", 7/8"

A7402DZ SOCKETS 3/8" BI-HEX, LONG SERIES, AEROSPACE

3/8", 7/16", 1/2", 9/16", 19/32", 5/8", 11/16", 3/4", 13/16", 7/8"

6950SL REVERSIBLE RATCHET 1/4", SLIMHEAD

6954 T HANDLE 1/4"

6956 SPINNER HANDLE 1/4"

6962L EXTENSION BAR 1/4"

355 mm

6966 UNIVERSAL JOINT 1/4"

6972H BIT HOLDER 3/8"

7407H BIT HOLDER 3/8"

1/4" - 3/8"

7408H BIT HOLDER 3/8"

5/16" - 3/8"

7752 SPEEDER 3/8"

7750SL RATCHET 3/8" SLIMHEAD

7760 / 7762 EXTENSION BAR 3/8"

75, 125, 250 mm

7764 ADAPTOR F 3/8" - 1/4"

7765 ADAPTOR F 1/4" - 3/8"

7766 ADAPTOR F 3/8" - 5/8"

7767 ADAPTOR F 5/8" - 1 1/4"

7768 ADAPTOR F 1 1/4" - 2"

7769 ADAPTOR F 2" - 3"

7770 ADAPTOR F 3" - 4"

7771 ADAPTOR F 4" - 6"

7772 ADAPTOR F 6" - 8"

7773 ADAPTOR F 8" - 12"

7774 ADAPTOR F 12" - 18"

7775 ADAPTOR F 18" - 24"

7776 ADAPTOR F 24" - 36"

7777 ADAPTOR F 36" - 48"

7778 ADAPTOR F 48" - 60"

7779 ADAPTOR F 60" - 72"

7780 ADAPTOR F 72" - 84"

7781 ADAPTOR F 84" - 96"

7782 ADAPTOR F 96" - 108"

7783 ADAPTOR F 108" - 120"

7784 ADAPTOR F 120" - 132"

7785 ADAPTOR F 132" - 144"

7786 ADAPTOR F 144" - 156"

7787 ADAPTOR F 156" - 168"

7788 ADAPTOR F 168" - 180"



FF2A08 - 24 pcs

111Z COMBINATION WRENCHES

1/4", 5/16", 3/8", 7/16", 1/2", 9/16", 5/8", 11/16", 3/4", 7/8", 1"

1320RZ RATCHETING RING WRENCHES

1/4X5/16", 5/16X11/32", 3/8X7/16", 1/2X9/16"

1931Z LILIPUT DOUBLE OPEN-END WRENCHES

3/16", 7/32", 1/4"

9031 C ADJUSTABLE WRENCH 8", ERGO™, CHROMED

218x38 mm

208 MINI HACKSAW FRAMES

250 mm

1-100-04-2-2 4" FLAT FILE, ERGO™, WITH HANDLE, SECOND

1-230-04-2-2 4" ROUND HAND FILE, ERGO™, WITH HANDLE, SECOND

1177 SCRIBE OFFSET SCRIBER 20 mm

1950MZ-3/8 CROWFOOT ADJUSTABLE WRENCH 3/8"



HIGH PROTECTION RIGID CASE COMPOSITIONS

4750RCHD01FF1

159 PCS

- Aviation Mechanics, especially for mobile application
- Hardware: 4750RCHD01. Heavy Duty Rigid Case without wheels
- Suitable for all airplanes
- Inch
- Sizes: 1/4; 3/8



ERGO TOOL MANAGEMENT SYSTEM



FF2A09 - 56 pcs

BE-8210 SCREWDRIVERS ERGO™ SLOTTED

0.4X2, 5X75 mm

BE-8040 SCREWDRIVER ERGO™ SLOTTED

0.8X4, 0X100

BE-8150 SCREWDRIVERS ERGO™ SLOTTED

1.0X5, 5X100 mm

BE-8260 SCREWDRIVER ERGO™

SLOTTED, HEX PROFILE & BOLSTER

1.6X8, 0X175

BE-8600 / BE-8620 SCREWDRIVERS ERGO™ PHILLIPS

PH0X60, PH1X75, PH2X100

BE-8760 BLACK HEX KEYS SET,

LONG BALL END, 12 PCS

0.050", 1/16", 5/64", 3/32", 7/64", 1/8", 9/64", 5/32", 3/16",

7/32", 1/4", 5/16"

2047-1-5.5 DOUBLE OFFSET KEY FOR SLOTTED SCREWS

1X9, 6X125 mm

BFLA01 B3 LED TORCH

59/S28-4 BITS SET ERGO™ TORX®, PHILLIPS®, TORX®,

HEXAGON AND TORQ-SET® HEAD SCREWS

28 PCS

08050 RATCHETING BIT SCREWDRIVER

MTB-3-16-E MEASURING TAPE

3 m

1179-FLX-2 FLEXIBLE MEASUR. ROD 300mm/1inch

5515-152 TELESCOPIC SWIVEL HEAD MIRROR

Ø 50 mm

2509 FLEXIBLE PICK-UP TOOL

525 mm

2530-2 MAGNETIC PICK-UP TOOL

1 kg



FF2A10 - 15 pcs

481-300 DIN HAMMER

300 mm

3625W-35 PLASTIC HAMMER

2101GC-160IP SIDE CUTTING PLIER, ERGO™

160 mm

2650 SLIP JOINT, CONNECTOR PLIER

2628 GC-160IP COMBINATION CHROMED PLIER, ERGO™

160 mm

2427 GC-200IP LONG, ROUND NOSE CHROMED PLIER,

ERGO™

200 mm

2855 WIRE TWISTING PLIER

224 mm

8224CIP SLIP JOINT PLIER, ERGO™

3734-2 DRIFT PUNCHES

2-150, 3-150, 4-150, 5-150 mm

3735-4-120 CENTRE PUNCH

120 mm

2632 COMBINATION COTTER PIN EXTRACTOR AND

SPREADER

170 mm

2979 D-180 FLAT NOSE NUT-PLIER

180/3-13 mm





METALLIC CASES COMBINATIONS

■ 1483KHD3RB-FF1

129 PCS

- Aviation Mechanics, suitable for all large airplanes
- Hardware: 1483KHD3RB. Heavy Duty Rigid Case without wheels
- Especially for line maintenance
- 12 Inch
- Sizes: 1/4"; 3/8"



LID ASSORTMENT - 5 pcs

- 481-500 DIN HAMMER
500 mm
- 3625N-32 PLASTIC HAMMER
- 2509 FLEXIBLE PICK-UP TOOL
525 mm
- 8162-1/2 EXTENSION BAR 1/2"
250 mm
- 7762 EXTENSION BAR 3/8"
250 mm



FF3A01 - 79 pcs

- 62 DOUBLE-OPEN END WRENCHES
7/8x15/16", 1x1.1/8", 1.1/16-1.1/4"
- 6950SL REVERSIBLE SPANNER 1/4", SLIMHEAD
- 6996 SPINNER HANDLE 1/4"
- 6958 BREAKER BAR 1/4"
- 6960 EXTENSION BAR 1/4"
50 mm
- 6961 EXTENSION BAR 1/4"
100 mm
- 6966 UNIVERSAL JOINT 1/4"
- 7750SL RATCHET 3/8" SLIMHEAD
- 7762 SPEEDER 3/8"
- 7760 1/2" EXTENSION BAR 3/8"
- 76125 mm
- 7764 ADAPTOR F 3/8" - M 1/4"
- 7765 ADAPTOR F 1/4" - M 3/8"
- 7766 UNIVERSAL JOINT 3/8"
- 6072H BIT HOLDER 1/4"
- 7407H BIT HOLDER 3/8"
1/4" - 3/8"

8164-1/2 ADAPTOR F 3/8" - M 1/2"

8165-1/2 ADAPTOR F 1/2" - M 3/8"

A6700DZ SOCKET 1/4", BI-HEX, AEROSPACE SHORT SERIES
7/32", 1/4", 9/32", 5/16", 11/32", 3/8", 7/16", 1/2",

A6800DZ SOCKETS 1/4" BI-HEX, AEROSPACE LONG SERIES
7/32", 1/4", 9/32", 5/16"

A7400DM SOCKETS 3/8", BI-HEX, AEROSPACE SHORT
SERIES 10, 13 mm

A7400DZ SOCKETS 3/8", BI-HEX, SHORT SERIES
1/2", 9/16", 5/8", 11/16", 3/4"

A7402DZ SOCKETS 3/8", BI-HEX, LONG SERIES, AEROSPACE
3/8", 7/16", 1/2", 9/16"

7800DZ SOCKET 1/2", BI-HEX SHORT SERIES
13/16", 7/8", 1"

E94S28-4 BITS SET FOR SLOTTED PHILLIPS TORX,
HEXAGON AND TORQ-SET® HEAD SCREWS 2.7x3.5

A6770DZ SWIVEL SOCKETS 1/4",
BI-HEX, AEROSPACE 5/16", 3/8", 7/16"

1320RZ RATCHETING RING WRENCHES
1/4X5/16", 3/8X7/16"

1483KCART



METALLIC CASES COMPOSITE

1483KHD3RB-FF1

129 PCS

- Aviation Mechanics, suitable for all large airplanes
- Hardware: 1483KHD3RB. Heavy Duty Rigid Case without wheels
- Especially for line maintenance
- 1 Inch
- Sizes: 1/4; 3/8



FF3A02 - 13 pcs

- 2047-1,2-8 OFFSET SCREWDRIVER
1.2x8x150
- 2047PR-1-2 DOUBLE OFFSET KEY FOR PHILLIPS SCREWS
PH1 & 2
- BE-8020L SCREWDRIVER ERGO™, SLOTTED
0.5x3x75
- BE-8155 SCREWDRIVER ERGO™,
SLOTTED
1.2x6.5x125
- BE-8260 SCREWDRIVER ERGO™
SLOTTED, HEX PROFILE & BOLLSTER
1.8x1.5x175
- BE-8611 / BE-8621 SCREWDRIVERS ERGO™, PHILLIPS
PH1x75, PH2x100
- BE-8601 SCREWDRIVER ERGO™ PHILLIPS, STUBBY
PH1x25
- 9715-14-250 THROUGH BLADE SCREWDRIVER
2.5x14x250
- 5515T-52 TELESCOPIC SWIVEL HEAD MIRROR
Ø 50 mm
- 1177-SCRIBE OFFSET SCRIBER 230mm
- BE-3529 O-RING LEVER
175 mm
- 1150-1721VP CALIPER
150 mm



FF3A03 - 12 pcs

- 21016C-160IP SIDE CUTTING PLIER, ERGO™
160 mm
- 24216C-180IP FLAT NOSE
180 mm
- 28550 WIRE TWISTING PLIER
282 mm
- 8224CIP SLIP JOINT PLIER, ERGO™
- MTB-3-16 MEASURING TAPE
3 m
- 3658A DRIFT PUNCHES WITH HAND PROTECTION
2x150, 3x150, 5x150 mm
- BFLB01 Q3 LED TORCH
45480030 ALUMINIUM TRIP PUNCH
25 x 150 mm
- 1151-1 FIRE PROHIBITER
30 mm hwh
- 1151-21 ROLLMEETER
80 mm



FF3A04 - 20 pcs

- 8158-1/2 BREAKER BAR
380 mm
- 1300Z DOUBLE RING END WRENCH, OFFSET
1/4x5/16", 3/8x7/16", 1/2x9/16", 19/32x11/16", 5/8x3/4",
25/32x13/16", 7/8x15/16"
- 1931Z LILIPUT DOUBLE OPEN-END WRENCHES
7/32", 1/4"
- 6Z DOUBLE OPEN-END WRENCHES
1/4x5/16", 3/8x7/16", 1/2x9/16", 19/32x11/16", 5/8x3/4",
25/32x13/16"
- 9070C ADJUSTABLE WRENCH CHROMED 6" ERGO™
158x20 mm
- XID1618A DOUBLE RING WRENCH
1/4x9/32"
- XID1514A DOUBLE RING WRENCH - WRENCH
7/32" x 15/64"
- DS2018A BOXCKET
5/16x9/32"





METALLIC CASES COMPOSITIONS

■ 1483KHD3RB-FF2

152 PCS

- Aviation Mechanics, suitable for all large airplanes
- Hardware: 1483KHD3RB: Heavy Duty Rigid Case without wheels
- Especially for line maintenance
- 18 Inch
- Sizes: 1/4; 3/8

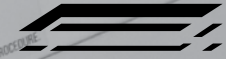

ERGO TOOL MANAGEMENT SYSTEM



LID ASSORTMENT - 5 pcs

- 481-400 DIN HAMMER
400 mm
- 3625N-35 PLASTIC HAMMER
- 2509 FLEXIBLE PICK-UP TOOL
525 mm
- 2535F2 MAGNETIC PICK-UP TOOL
1 kg
- 7762 EXTENSION BAR 3/8"
250 mm



FF3A05 - 98 pcs

- 6950SL REVERSIBLE RATCHET 1/4", SLIM HEAD
- 7750SL RATCHET 3/8" SLIM HEAD
- 6960 / 6965 EXTENSION BARS 1/4"
50, 150 mm
- 7760 / 7761 EXTENSION BARS 3/8"
75, 125 mm
- 6956 SPINNER HANDLE 1/4"
- 7752 SPEEDER 3/8"
- 6966 UNIVERSAL JOINT 1/4"
- 7766 UNIVERSAL JOINT 3/8"
- 7764 ADAPTOR F 3/8" - 1/4"
- 7765 ADAPTOR F 1/2" - 1/2 1/4"

A6800DM-4 SOCKET 1/4", BI-HEX LONG SERIES

4 mm

A6800DZ SOCKETS 1/4" BI-HEX, AEROSPACE LONG SERIES

1/4", 9/32", 5/16", 3/8", 11/32", 7/16", 1/2", 9/16", 3/16", 7/32"

A7400DZ SOCKETS 3/8" BI-HEX, AEROSPACE SHORT SERIES

3/8", 7/16", 1/2", 17/32", 9/16", 19/32", 5/8", 11/16", 3/4", 13/16", 17/32"

BE-9780 BLACK HEX KEYS SET,

LONG BALL END, 12 PCS

0.050", 1/16", 5/64", 3/32", 7/64", 1/8", 9/64", 5/32", 3/16", 7/32", 1/4", 5/16"

59/S28-4 BITS SET FOR SLOTTED, PHILLIPS, TORX®,

HEXAGON AND TORQ-SET® HEAD SCREWS

28 PCS

907 TC ADJUSTABLE WRENCH CHROME VANADIUM

808650 RATCHETING BIT SCREWDRIVER

2058-BR BIT-RATCHET 1/4"

1544 FEELER GAUGE

KE18-01 ERGO™ KNIFE

70S/T51/4 BIT TORQ-SET

1/4 32 mm 5/16

6163-112 ADAPTOR 1/2" - 1/2 1/4"

6164-112 ADAPTOR 1/2" - 1/2 1/4"

6972H BIT HOLDER 1/4"

7407H BIT HOLDER 3/8"

1/4" - 3/8"

A6700DZ SOCKET 1/4", BI-HEX, AEROSPACE SHORT SERIES

3/16", 7/32", 1/4", 9/32", 5/16", 11/32", 3/8", 7/16", 1/2", 9/16"

A6710DZ SWIVEL SOCKETS 1/4",

BI-HEX, AEROSPACE

1/4", 5/16", 11/32", 3/8", 7/16"

1483KCART



METALLIC CASES COMPOSITE

1483KHD3RB-FF2

152 PCS

- Aviation Mechanics, suitable for all large airplanes
- Hardware: 1483KHD3RB. Heavy Duty Rigid Case without wheels
- Especially for line maintenance
- Inch
- Sizes: 1/4; 3/8



FF3A06 - 15 pcs

2047-1-5.5 DOUBLE OFFSET KEY FOR SLOTTED SCREWS

1X5, 5X125 mm

2047PR-1-2 DOUBLE OFFSET KEY FOR PHILLIPS SCREWS

PH 1-2

BE-8030 SCREWDRIVER ERGO™

SLOTTED

0.6X3, 5X75

BE-8155 SCREWDRIVER ERGO™

SLOTTED

1.2X8, 5X125

BE-8150 SCREWDRIVERS ERGO™ SLOTTED

1.0X5, 5X100 mm

BE-8260 SCREWDRIVER ERGO™

SLOTTED, HEX PROBE & BOLSTER

1.6X8, 0X175

BE-8350 SCREWDRIVER ERGO™

SLOTTED, STUBBY

1X5, 5X25

BE-8602 SCREWDRIVER ERGO™, PHILLIPS, STUBBY

RN8X95

BE-8610 / BE-8620 SCREWDRIVERS ERGO™ PHILLIPS

PH1X75, PH2X100

95131-32 TELESCOPIC SWIVEL HEAD MIRROR

Ø 50 mm

1177-SCRIBE OFFSET SCRIBER 230mm

1180-1-1-2 DEPTH GAUGE SCREWDRIVER

800 mm

704Z-3/32 PRECISION HEX BALL SCREWDRIVER

3/32X75

1150-1/2H/P CALIPER 150MM



FF3A07 - 11 pcs

MTB-3-16 MEASURING TAPE

3 m

2101GC-160IP SIDE GRIP COMBINATION PLIER, ERGO™

160 mm

2427 GC-200IP LONG, ROUND NOSE CHROMED PLIER,

ERGO™

200 mm

2855 WIRE TWISTING PLIER

224 mm

8224CIP SLIP JOINT PLIER, ERGO™

2650 SLIP JOINT, CONNECTOR PLIER

2628 GC-160IP COMBINATION CHROMED PLIER, ERGO™

160 mm

2632 200mm END GRIP

31-READER

170 mm

3134 DRIFT PUNCHES

Ø 3, 5, 8 mm



FF3A08 - 23 pcs

1320RZ RATCHETING RING WRENCHES

1/4X5/16", 3/8X7/16", 1/2X9/16", 5/16X11/32"

6Z DOUBLE OPEN-END WRENCHES

1/4X5/16", 5/16X11/32", 3/8X7/16", 1/2X9/16",

19/32X11/16", 5/8X3/4", 13/16X7/8"

1952Z COMBINATION WRENCH

1/4", 5/16", 11/32", 3/8", 7/16", 1/2", 9/16", 5/8", 11/16,

3/4", 13/16", 7/8"





METALLIC CASES COMPARISONS

■ 1483KHD3RB-FF3

193 PCS

- General Purpose
- Hardware: 1483KHD3RB, Heavy Duty Rigid Case without wheels
- Metric
- Sizes: 1/4

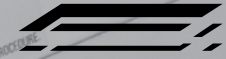

ERGO TOOL MANAGEMENT SYSTEM



LID ASSORTMENT - 5 pcs

- 481-300 DIN HAMMER
- 300 mm
- 3625N-32 PLASTIC HAMMER
- 2509 FLEXIBLE PICK-UP TOOL
- 525 mm
- 2535F2 MAGNETIC PICK-UP TOOL
- 1 kg
- 7762 EXTENSION BAR 3/8"
- 250 mm



FF3A09 - 95 pcs

- 6700SM SOCKET 1/4", AEROSPACE, SHORT SERIES
- 5.5, 6, 7, 8, 9, 10, 11, 12, 13
- A6800DM SOCKET 1/4", AEROSPACE LONG SERIES
- 5.5, 6, 7, 8, 9, 10, 11, 12, 13
- 6709M SOCKET DRIVER 1/4", HEX
- 3, 4, 5, 6, 8
- 6709PH SOCKET DRIVER 1/4", PH
- 1, 2, 3
- 6709TORX SOCKET DRIVER 1/4", TORX®
- T8, T9, T10, T15, T20, T25, T27, T30, T40
- 6950L REVERSIBLE RATCHET 1/4", SLIMHEAD
- 6954 T-HANDLE 1/4"
- 6956 HAMMER 1/4"
- 6958 SOCKET DRIVER 1/4"
- 6960 / 6961 / 6962 / 6962L EXTENSION BARS 1/4"
- 50, 100, 150, 365 mm
- 6966 UNIVERSAL JOINT 1/4"
- 6972H BIT HOLDER 1/4"
- 7764 ADAPTOR F 3/8" - M 1/4"

7400SM SOCKET 3/8", SHORT SERIES

6, 7, 8, 9, 10, 11, 12, 13, 14, 15, 16, 17, 18, 19, 22

A7402DM SOCKET 3/8", AEROSPACE LONG SERIES

10, 11, 12, 13, 14, 15, 16, 17, 18, 19

7409M SOCKET DRIVER 3/8" HEX,

3, 4, 5, 6, 7, 8, 10

7409TORX SOCKET DRIVER 3/8", TORX®

T25, T27, T30, T40, T45, T50

7750SL RATCHET 3/8" SLIMHEAD

7754 T-HANDLE 3/8"

7758 BREAKER BAR 3/8"

7760 / 7761

EXTENSION BARS 3/8" 75, 125 mm

7766 UNIVERSAL JOINT 3/8"

7768 ADAPTOR F 1/4" - M 3/8"

816-1/2 ADAPTOR F 3/8" - M 1/2"

7407H SOCKET HOLDER 3/8"

1/4" - 3/8"

2058-BR BIT-RATCHET 1/4"

1544 FEELER GAUGE



1483KHD3RB-FF3



METALLIC CASES COMPOSITE

1483KHD3RB-FF3

193 PCS

- General Purpose
- Hardware: 1483KHD3RB. Heavy Duty Rigid Case without wheels
- Metric
- Sizes: 1/4



FF3A10 - 53 pcs

- 808050S RATCHETING SCREWDRIVER, STUBBY
- 808050P PISTOL HANDLE RATCHETING SCREWDRIVER
- 59S/31-1 BITS SET
- 31 PCS. PH, PZ, TORX®, HEX, SL
- 2047-0.8-4 OFFSET SCREWDRIVER
- 0.8X4X100
- 2047PR-1-2 DOUBLE OFFSET KEY FOR PHILLIPS SCREWS PH1 & 2
- BE-8020L SCREWDRIVER ERGO™, SLOTTED
- 0.5X3.5X75
- BE-8030 SCREWDRIVER ERGO™, SLOTTED
- 0.6X3.5X75
- BE-8155 SCREWDRIVER ERGO™, SLOTTED
- 1.2X6.5X125
- BE-8208 SCREWDRIVER ERGO™, SLOTTED, HEX PROFILE & BOLSTER
- 1.6X8.0X175
- BE-8350 SCREWDRIVER ERGO™, SLOTTED, STUBBY
- 1X5.5X25
- BE-8601 / BE-8602 SCREWDRIVERS ERGO™, PHILLIPS, STUBBY
- PH1X25, PH2X25
- BE-8610 / BE-8620 SCREWDRIVERS ERGO™, PHILLIPS
- PH1X75, PH2X100
- BE-9770 BLACK HEX KEYS SET, LONG BALL END, 9 PCS
- HEX 1.5, 2, 2.5, 3, 4, 5, 6, 8, 10



FF3A11 - 12 pcs

- 21016C SIDE CUTTER ERGO™
- 160 mm
- 2427 GC-200IP LONG HANDLE ROSS CHROMED PLIER, ERGO™
- 200 mm
- 2430 GC-200 IP SNIPE NOSE CHROMED PLIER, ERGO™
- 200 mm
- 2628 GC-160IP COMBINATION CHROMED PLIER, ERGO™
- 160 mm
- 8224PIP SLIP JOINT PLIER, ERGO™
- 3734 DRIFT PUNCHES
- Ø 3, 5, 8 mm
- 3735 A-120 CENTER ANVIL
- 100 mm
- 1174 SCRIBE OFFSET GUNDRILL
- 1150-1/2H/P CALIPER
- 160 mm
- MTB-3-16 MEASURING TAPE
- 3 m



FF3A12 - 28 pcs

- 111M COMBINATION WRENCH
- 6, 7, 8, 9, 10, 11, 12, 13, 14, 15, 16, 17, 18, 19, 21, 22
- 6M OPEN END WRENCH
- 6x7, 8x9, 10x11, 12x13, 14x15, 16x17, 18x19, 20x22
- 9070C ADJUSTABLE WRENCH CHROMED 6" ERGO™
- 158x20 mm
- 5515T-52 TELESCOPIC SWIVEL HEAD MIRROR
- Ø 50 mm
- 2820EF2 ELECTRICIANS KNIFE
- BFLA01 SUPRABEAM Q3 LED-TORCH



METALLIC CASES COMPOSITIONS

■ 1483KHD3RB-FF4

146 PCS

- General Purpose
- Hardware: 1483KHD3RB, Heavy Duty Rigid Case without wheels
- Metric
- Sizes: 1/2



LID ASSORTMENT - 4 pcs

- 481-500 DIN HAMMER
500 mm
- 3625N-32 PLASTIC HAMMER
- 2509 FLEXIBLE PICK-UP TOOL
525 mm
- 2535F2 MAGNETIC PICK-UP TOOL
1 kg



FF3A13 - 49 pcs

- 7800SM SOCKET 1/2", SHORT SERIES 10, 11, 12, 13, 14, 15, 16, 17, 18, 19, 21, 22, 24, 27, 30, 32
- 7809M SOCKET DRIVER
5, 6, 8, 10, 12, 14, 17, 19
- 7809TORX SOCKET DRIVER 1/2", TORX®
T20, T25, T27, T30, T40, T45, T50, T55, T60
- 8154-1/2 T-HANDLE 1/2"
- 8150SL RATCHET 1/2", SLIMHEAD
- 8160-1/2 EXTENSION BAR 1/2",
125 mm
- 8162-1/2 EXTENSION BAR 1/2",
250 mm
- 8164-1/2 ADAPTOR 3/8" - M 1/2"



FF3A10 - 53 pcs

- 808050P PISTOL HANDLE RATCHETING SCREWDRIVER
- 808050S RATCHETING SCREWDRIVER, STUBBY
- 59S/31-1 BIT-SET
PH, PZ, TORX®, SL
- 2047-0.8-4 OFFSET SCREWDRIVER
0.8X4X100
- 2047PR-1-2 DOUBLE OFFSET KEY FOR PHILLIPS SCREWS
PH1 & 2
- BE-8020L SCREWDRIVER ERGO™, SLOTTED
0.5X3X75
- BE-8030 SCREWDRIVER ERGO™
SLOTTED
0.6X3.5X75
- BE-8155 SCREWDRIVER ERGO™
SLOTTED
1.2X6.5X125
- BE-8260 SCREWDRIVER ERGO™
SLOTTED, HEX PROFILE & BOLSTER
1.6X8.0X175
- BE-8350 SCREWDRIVER ERGO™
SLOTTED, STUBBY
1X5.5X25
- BE-8601 / BE-8602 SCREWDRIVERS ERGO™, PHILLIPS,
STUBBY
PH1X25, PH2X25
- BE-8610 / BE-8620 SCREWDRIVERS ERGO™, PHILLIPS
PH1X75, PH2X100
- BE-8770 BLACK HEX KEYS SET, LONG BALL END, 9 PCS
HEX 1.5, 2, 2.5, 3, 4, 5, 6, 8, 10



- 8165-1/2 ADAPTOR F 1/2" - M 3/8
- 9064 ADAPTOR F 1/2" - M 3/4
- 7807H SOCKET HOLDER 1/2"
- 111M COMBINATION WRENCH
24, 27, 30, 32
- 6M OPEN END WRENCH
24x27, 30x32

1483KCART



METALLIC CASES COMPOSITE

1483KHD3RB-FF4

146 PCS

- General Purpose
- Hardware: 1483KHD3RB. Heavy Duty Rigid Case without wheels
- Metric
- Sizes: 1/2



FF3A11 - 12 pcs

MTB-3-16 MEASURING TAPE

3 m

21016C SIDE CUTTER ERGO™

160 mm

2427 GC-200IP LONG, ROUND NOSE CHROMED PLIER, ERGO™

200 mm

2430 GC-200 IP SNIP NOSE CHROMED PLIER, ERGO™

200 mm

2620 GC-160IP COMBINATION CHROMED PLIER, ERGO™

160 mm

822 TIP SLIP JOINT PLIER, ERGO™

160 mm

3734 DRIFT PINNACHES

Ø 3, 5, 8 mm

3735-4-120 CENTRE PUNCH

120 mm

1177 SCRIBE SET SET SCRIBER 200mm

1150-1/2H/P CALIPER

150 mm



FF3A12 - 28 pcs

111M COMBINATION WRENCH

6, 7, 8, 9, 10, 11, 12, 13, 14, 15, 16, 17, 18, 19, 21, 22

6M OPEN END WRENCH

10x9, 10x11, 12x13, 14x15, 16x17, 18x19, 20x22

9070C ADJUSTABLE WRENCH CHROMED 6" ERGO™

158x20 mm

5515T-52 TELESCOPIC SWIVEL HEAD MIRROR

Ø 50 mm

2820EF2 ELECTRICIANS KNIFE

BLUAD 1 Q3 LED-TORCH

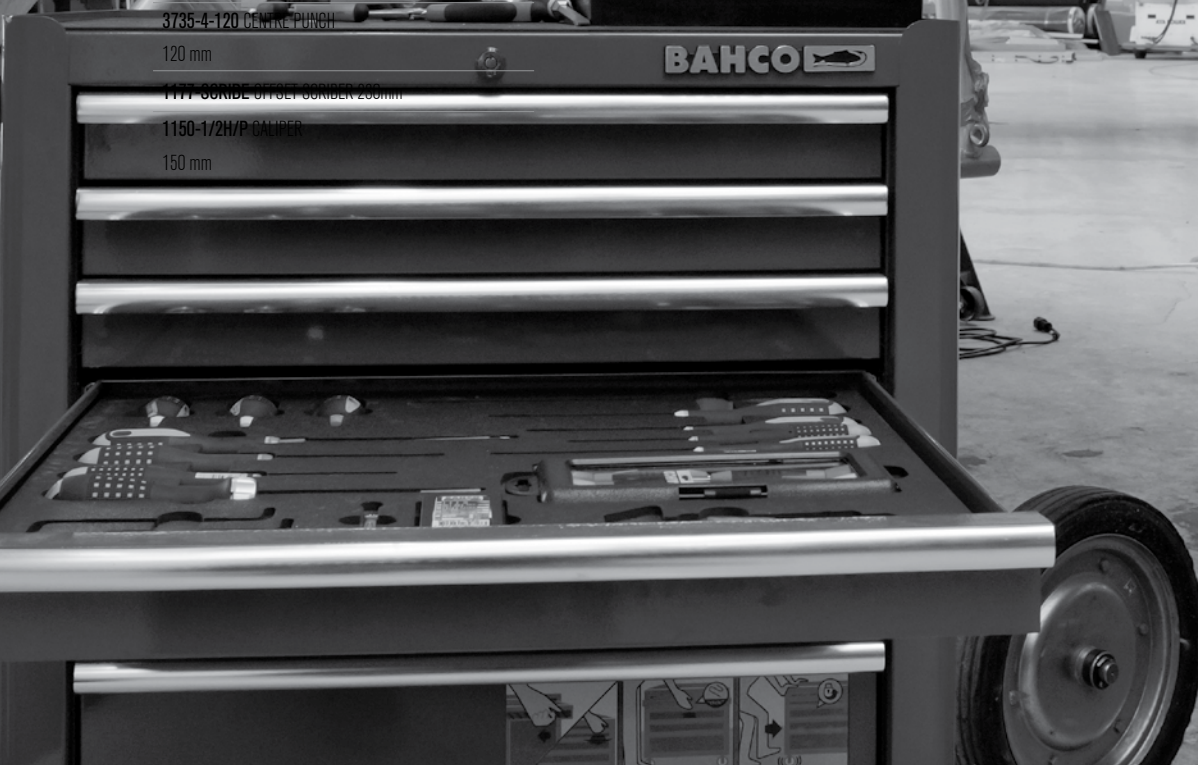



METALLIC CASES COMPOSITIONS

■ 1483KHD3RB-FF5

137 PCS

- Aviation Mechanics, suitable for all airplanes
- Hardware: 1483KHD3RB: Heavy Duty Rigid Case without wheels
- Especially for line maintenance
- 14 Inch
- Sizes: 1/4; 3/8

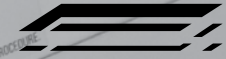

ERGO TOOL MANAGEMENT SYSTEM



LID ASSORTMENT - 4 pcs

- 481-500 DIN HAMMER
500 mm
- 3625N-32 PLASTIC HAMMER
- 2509 FLEXIBLE PICK-UP TOOL
525 mm
- 7762 EXTENSION BAR 3/8"
250 mm



FF3A14 - 77 pcs

- 111Z COMBINATION WRENCHES
1" - 1.178"
- 6Z/8C SET OF DOUBLE OPEN-END WRENCHES
1/4", 5/16", 3/8", 7/16", 1/2", 9/16",
19/32x11/16", 5/8x3/4", 13/16x7/8", 15/16x1"
- 6Z DOUBLE OPEN-END WRENCHES
1x1-1/8", 1.1/16x1.1/4"
- 6950SL REVERSIBLE RATCHET 1/4", SLIMHEAD
- 6960 / 6961 EXTENSION BARS 1/4"
50, 100 mm
- 6958 BREAKER BAR 1/4"
- 6966 UNIVERSAL JOINT 1/4"
- 7765 UNIVERSAL JOINT 3/8"
175, 200 mm
- 7762 UNIVERSAL JOINT 3/8"
175, 200 mm
- 7766 UNIVERSAL JOINT 3/8"
- 7768 / 7761 EXTENSION BARS 3/8" 5, 100 mm
- 7764 ADAPTOR F 3/8" - M 1/4"
- 7765 ADAPTOR F 1/4" - M 3/8"

8164-1/2 ADAPTOR F 3/8" - M 1/2"

8165-1/2 ADAPTOR F 1/2" - M 3/8"

6972H BIT HOLDER 1/4"

7407H BIT HOLDER 3/8"

1/4" - 3/8"

7408H BIT HOLDER 3/8"

5/16" - 3/8"

A6700DZ SOCKET 1/4", BI-HEX, AEROSPACE

7/32", 1/4", 9/32", 5/16", 11/32", 3/8", 7/16", 1/2", 9/16"

A6800DZ SOCKETS 1/4" BI-HEX, AEROSPACE

7/32", 1/4", 9/32", 5/16"

A7400DM SOCKETS 3/8", BI-HEX, AEROSPACE SHORT

SERIES 10, 13 mm

A7402DZ SOCKETS 3/8", BI-HEX, LONG SERIES, AEROSPACE

3/8", 7/16", 1/2", 9/16"

7800DZ SOCKETS 1/2", BI-HEX

15/16", 1"

59/S28-4 BITS SET FOR SLOTTED, PHILLIPS, TORX®,

HEXAGON AND TORQ-SET® HEAD SCREWS

28 PCS

1483KCART



METALLIC CASES COMPOSITE

1483KHD3RB-FF5

137 PCS

- Aviation Mechanics, suitable for all airplanes
- Hardware: 1483KHD3RB. Heavy Duty Rigid Case without wheels
- Especially for line maintenance
- Inch
- Sizes: 1/4; 3/8



FF3A15 - 14 pcs

- 1179-FLX-2 FLEXIBLE MEASUR. ROD
300 mm
- 20471.2-8 OFFSET SCREWDRIVER
0,8X4X100
- 2047PR-1-2 DOUBLE OFFSET KEY FOR PHILLIPS SCREWS
PH1 & 2
- BE-8020L SCREWDRIVER ERGO™, SLOTTED
0,5X3X75
- BE-8155 SCREWDRIVER ERGO™
SLOTTED
1,2X6,5X125
- BE-8860 SCREWDRIVER ERGO™
SLOTTED, HEX PROFILE & BOLSTER
1,6X8,0X175
- 9715-14-250 THROUGH BLADE SCREWDRIVER
2,5x14x250
- BE-8601 / BE-8602 SCREWDRIVERS ERGO™, PHILLIPS
STUBBY
PH1X25, PH2X25
- BE-8611 / BE-8621 SCREWDRIVERS ERGO™, PHILLIPS
PH1X75, PH2X100
- 1177-SCRIBE OFFSET SCRIBER 230mm
- 5515T-52 TELESCOPIC SWIVEL HEAD MIRROR
Ø 30 mm
- BE-3529 O-RING LEVER



FF3A16 - 12 pcs

- 2101GC-180IP SIDE CUTTING PLIER, ERGO™
180 mm
- 2421GC-180IP FLAT NOSE
180 mm
- 2855 D WIRE TWISTING PLIER
282 mm
- MTB-3-16-E MEASURING TAPE
3 m
- 3658A DRIFT PUNCHES WITH HAND PROTECTION
3x150, 5x150, 8x150 mm
- 8224 TIP SLIP JOINT PLIER, ERGO™
- BFLB01 Q3 LED TORCH
- 45480-300 ALUMINUM DRIFT PUNCH
300 x 100 mm
- 3740-120 FLAT CHISEL
150 mm
- 3733-4-120 CENTRE PUNCH
120 mm



FF3A17 - 30 pcs

- DS2018A DOUBLE OPEN-ENDED SPANNER
5/16"X9/32"
- BE-9780 BLACK HEX KEYS SET,
LONG BALL END, 12 PCS
0,050", 1/16", 5/64", 3/32", 7/64", 1/8", 9/64", 5/32", 3/16",
7/32", 1/4", 5/16"
- 1320RZ RATCHETING RING WRENCHES
1/4X5/16", 3/8X7/16"
- 1952Z COMBINATION WRENCH
11/32", 1/2", 9/16", 5/8", 11/16", 3/4", 13/16", 7/8"
- 2628 GC-180IP COMBINATION CHROMED PLIER, ERGO™
180 mm
- KE18-01 CUTTER KNIFE ERGO™
- 7758 BREAKER BAR 3/8"
- 1300Z DOUBLE RING END WRENCH, OFFSET
1/4X5/16", 3/8X7/16"
- 1931Z LILIPUT DOUBLE OPEN-END WRENCHES
7/32", 1/4"





AUTO REPAIR EXTRA LARGE COMPOSITION

1470K7FFAUTO

TROLLEY AND 7 DRAWERS FILLED COMPOSITION

- Trolley and 7 drawers Extra Large composition including:
 - 1/4; 3/8 and 1/2 socket drivers
 - Combination and ring end wrenches
 - Slotted, PH, PZ and TORX screwdrivers
- Suitable for all vehicle garages
- It comes with the 1470K7 orange trolley



7DR TROLLEY-FILLED AUTO

- 111M COMBINATION WRENCH 10, 11, 12, 13, 14, 15, 16, 17, 18, 19, 20, 21, 22, 24, 27, 30, 32 mm
- 1419-MD MAGNETIC DISH
- 208 HACKSAW FRAMES
- 2101G-160IP SIDE CUTTER 160 mm
- 2430 G-160 IP SNIPE NOSE CUTTING 160 mm
- 2444 CARPENTERS KNIFE
- 2509 FLEXIBLE PICK UP
- 2628 G-180IP COMBINATION PLIER 180 mm
- 268 MINIHACKSAW FRAMES
- 2744 MULTI-PURPOSE SNIP
- 2M RING WRENCH 6-7, 8-9, 10-11, 12-13, 14-15, 16-17, 18-19, 20-22, 21-23, 24-27, 25-28, 30-32 mm
- 319-3906 HACKSAW FRAME 319
- 3625N-35 PLASTIC HAMMER
- 3734 COTTER PIN PUNCH 2, 3, 4, 5, 6, 8 mm
- 3735-5-120 CENTER PUNCH
- 3740-175 FLAT CHISEL
- 4040M-10-11 FLEX HEAD SPANNER 8-9, 10-11, 12-13, 14-15, 16-17, 18-19, 20-22, 21-23 mm
- 481-400 GERMAN DIN-HAMMER
- 5515T TELESCOPIC MIRROR
- 59S/31-1 PZ1, PZ2 (x3), PZ3; PH1, PH2 (x3), PH3; PH2G (x2); T10, T15 (x3), T20 (x3), T25 (x2), T27, T30. SL: 3, 4, 5, 5.5mm; HEX: 3mm, 4, 5, 6mm. 1/4" Magnetic bit holder.
- 6700SM SOCKET 1/4 4, 4.5, 5, 5.5, 6, 7, 8, 8, 10, 11, 12, 13, 14
- 6950 RATCHET 1/4, PEAR TYPE 72T
- 6954 T-HANDLE

- 6956 SPINNER HANDLE 1/4
- 6960 EXTENSION 1/4 50 mm
- 6962 EXTENSION 1/4 150 mm
- 6966 UNIVERSAL JOINT 1/4
- 7400SM SOCKET 3/8 5, 6, 8, 9, 10, 11, 12, 13, 14, 16, 16, 17, 18, 19, 20, 21, 22 mm
- 7754 T-HANDLE 3/8
- 7755-3/8 RATCHET 3/8
- 7760 EXTENSION 3/8, 75 mm
- 7761 EXTENSION 3/8, 125 mm
- 7762 EXTENSION 3/8, 250 mm
- 7766 UNIVERSAL JOINT 3/8
- 7800SM SOCKET 1/2 8, 9, 10, 11, 12, 13, 14, 15, 16, 17, 18, 19, 20, 21, 22, 23, 24, 26, 27, 28, 30, 32 mm
- 7805SM 1/2IN DEEP SOCKET 10, 12, 13, 17, 19 mm
- 7809M SOCKET DRIVER 1/2, HEX 5, 6, 7, 8, 9, 10, 12, 14, 17, 19 mm
- 7809M-20-100 SOCKET DRIVER 1/2 HEX LONG
- 7809M-5-180 SOCKET DRIVER 1/2 HEX LONG
- 7809M-6-140 SOCKET DRIVER 1/2 HEX LONG
- 7809M-7-100 SOCKET DRIVER 1/2 HEX LONG
- 7809M-8-120 SOCKET DRIVER 1/2 HEX LONG
- 7809TORX-T25 SOCKET 1/2 125, 30, 40, 45, 50, 55 mm
- 808050 RATCHETING BIT SCREWDRIVER
- 8154 1/2 T HANDLE
- 8155-1/2 RATCHET 1/2
- 8160-1/2 EXTENSION 125 mm
- 8162-1/2 EXTENSION 250 mm
- 8166-1/2 UNIVERSAL JOINT 1/2

- 8224 IP SLIP JOINT PLIER 250 mm
- BBR201P6 XZN 1/2 IMP SOCK BIT BRAKE 6P
- BE5103 XZN 1/2 SOCKET W/BIT END 3P
- BE-0820L SCREWDRIVER ERGO 0.8X4X125
- BE-8040 SCREWDRIVER ERGO 1.0X5X100
- BE-8150 SCREWDRIVER ERGO 1.0X5.5X100
- BE-8255 SCREWDRIVER ERGO 1.2X6.5X150
- BE-8256 SCREWDRIVER ERGO 1.6X8.0X150
- BE-8340 SCREWDRIVER ERGO 0.8X4X25
- BE-8601 SCREWDRIVER ERGO PH1X25
- BE-8610 SCREWDRIVER ERGO PH1X75
- BE-8620 SCREWDRIVER ERGO PH2X100
- BE-8906 SCREWDRIVER ERGO TX 6X75
- BE-8907 SCREWDRIVER ERGO TX 7X75
- BE-8908 SCREWDRIVER ERGO TX 8X75
- BE-8909 SCREWDRIVER ERGO TX 9X75
- BE-8910 SCREWDRIVER ERGO TX 10X75
- BE-8915 SCREWDRIVER ERGO TX 15X100
- BE-8920 SCREWDRIVER ERGO TX 20X100
- BE-8925 SCREWDRIVER ERGO TX 25X125
- BE-8927 SCREWDRIVER ERGO TX 27X125
- BE-8930 SCREWDRIVER ERGO TX 30X150
- BE-8940 SCREWDRIVER ERGOTX 40X150
- BE-8945 SCREWDRIVER ERGO TX 45X150
- BE-9678 BLACK KEYS SETS FOR HEX SCREWS LONG BALL END 1.5, 2, 2.5, 3, 4, 5, 6, 8, 10 mm
- MTB-5-25 5M TAPE MEASURE 25 mm





AUTO REPAIR LARGE COMPOSITION

FF1ASET-AUTO1

5 DRAWERS FILLED COMPOSITION. 196 TOOLS

- 5 inlays Large composition including:
 - 1/4 and 1/2 socket drivers
 - Combination and ring end wrenches
 - Slotted, PH and TORX screwdrivers
- Suitable for all vehicle garages
- Compatible with all trolleys



AUTO LARGE COMPOSITION

2M DOUBLE END BOX SPANNER 6-7, 8-9, 10-11, 12-13,

14-15, 16-17, 18-19, 20-22, 21-23, 24-27, 30-32

111M COMBINATION WRENCH 6, 7, 8, 9, 10, 11, 12, 13, 14,

15, 16, 17, 18, 19, 21, 22, 24, 27, 30, 32 mm

4040M FLEX HEAD WRENCH 10-11, 12-13, 14-15, 16-17,

18-19, 21-23

7800SM SOCKET 1/2 10, 12, 13, 14, 15, 16, 17, 18, 19, 20,

21, 22, 23, 24, 27, 30, 32 mm

7805SM SOCKET DEEP 1/2" 13, 16, 17, 18, 19, 21, 22, 24,

27, 30, 32 mm

7809M-3 SOCKET DRIVER 1/2, HEX 5, 6, 8, 10, 12, 14

8158-1/2 BREAKER BAR 400 MM 1/2

8154-1/2 SLIDING T-HANDLE 1/2

8159-1/2 EXTENSION BAR 1/2-75 mm

8160-1/2 EXTENSION BAR 1/2-125 mm

8166-1/2 UNIVERSAL JOINT 1/2

8150SL REVERSIBLE RATCHET 1/2

6700SM SOCKET 1/4 4, 4.5, 5, 5.5, 6, 7, 8, 9, 10, 11, 12,

13 mm

6958 BREAKER BAR 1/4"

6954 T-HANDLE 1/4

6960 EXTENSION BAR 1/4 -50 mm

6962 EXTENSION BAR 1/4 -150 mm

6966 UNIVERSAL JOINT 1/4"

593/31-T PZ1, PZ2 (x3), PZ3; PH1, PH2 (x3), PH3; PH2G

(x2); T10, T15 (x3), T20 (x3), T25 (x2), T27, T30. SL: 3, 4.5,

5.5mm; HEX: 3mm, 4, 5, 6mm. 1/4" Magnetic bit holder.

6950SL PEAR TYPE RATCHET 1/4"

3735-4-120 CENTRE PUNCH

3734 CUTTER PIN PUNCH 2, 3, 4, 5, 6, 8 mm

3734 CUTTER PIN PUNCH 2, 3, 4, 5, 6, 8 mm

SCREWDRIVER ERGO 8X175

BE-8255 SCREWDRIVER ERGO 6.5X150

BE-8242 SCREWDRIVER ERGO 5.5X125

BE-8040 SCREWDRIVER ERGO 4X100

BE-8030 SCREWDRIVER ERGO 3.5X75

BE-8611 SCREWDRIVER ERGO PH 1X100

BE-8620 SCREWDRIVER ERGO PH 2X125

BE-8910 SCREWDRIVER ERGO TORX T-10X75

BE-8915 SCREWDRIVER ERGO TORX T-15X100

BE-8920 SCREWDRIVER ERGO TORX T-20X100

BE-8925 SCREWDRIVER ERGO TORX T-25X125

BE-8930 SCREWDRIVER ERGO TORX T-30X150

BE-8935 SCREWDRIVER ERGO TORX T-40X150

BE-8577 BIT HOLDER 1/4

BE-8355 SCRWD FLAT STUBBY 6.5X25

BE-8602 SCRWD PH 2X25

2630B-160IP COMBINATION PLIER 160 mm

2490 G-200 SHARP NOSE CUTTING 200mm

2497 G-200 SHARP NOSE 200mm

2900-180 CIRCLIP PLIER 290-180

2890-180 CIRCLIP PLIER 2890-180

2990-180 CIRCLIP PLIER 2990-180

2800-180 CIRCLIP PLIER 2800-180

7224 SLIP JOINT PLIER 2971G-250

2953-250 UNLOCKING CURVED PLIER 250

2101G-160IP SIDE CUTTER 160 mm

479-16 BALL PEIN HAMMER

3625N-35 PLASTIC HAMMER

1547 FEELER GAUGED 05-1 20BLADE

4532-A UNIV TWO-ARM PULLER

2446 STAINLESS STEEL CARPENTER KNIF

MTB-3-16 3M TAPE MEASURE 16MM CARDED

SC127 ELECTRICIAN'S SCISSORS 127MM

9070 ADJUSTABLE WRENCH 8070 6"

BE-9678 BLACK KEYS SETS FOR HEX SCREWS, LONG BALL

END 1.5, 2, 2.5, 3, 4, 5, 6, 8, 10

BE-9575 BLACK KEYS SETS FOR TORX SCREWS, LONG BALL

END T9, 10, 15, 20, 25, 27, 30, 40



AUTO REPAIR MEDIUM COMPOSITION

FF1ASET-AUTO2

4 DRAWERS FILLED COMPOSITION. 168 TOOLS



- 4 inlays Medium composition including:
 - 1/4 and 1/2 socket drivers
 - Combination wrenches
 - Slotted, PH and TORX screwdrivers
- Suitable for all vehicle garages
- Compatible with all trolleys



ERGO TOOL MANAGEMENT SYSTEM



AUTO MEDIUM COMPOSITION

111M COMBINATION WRENCH 6, 7, 8, 9, 10, 11, 12, 13, 14, 15, 16, 17, 18, 19, 21, 22, 24, 27, 30, 32 mm

7800SM SOCKET 1/2 10, 12, 13, 14, 15, 16, 17, 18, 19, 20, 21, 22, 23, 24, 27, 30, 32 mm

8154-1/2 T-HANDLE

8159-1/2 EXTENSION

8160-1/2 EXTENSION

8166-1/2 UNIVERSAL JOINT

8150SL RATCHET 1/2, SLIM HEAD 72T

6700SM 1/4 SOCKET 1/4 4, 4.5, 5, 5.5, 6, 7, 8, 9, 10, 11, 12, 13 mm

6954 T-HANDLE

6960 EXTENSION 1/4

6962 EXTENSION 1/4

6966 UNIVERSAL JOINT

59S/31-1 PZ1, PZ2 (x3), PZ3; PH1, PH2 (x3), PH3; PH2G (x2); T10, T15 (x3), T20 (x3), T25 (x2), T27, T30; SL: 3, 4, 5, 5.5mm; HEX: 3mm, 4, 5, 6mm, 1/4" Magnetic bit holder

6950SL RATCHET 1/4, SLIM HEAD 72T

3735 4-120 CENTRE PUNCH

3734 COTTER PIN PUNCH 2, 3, 4, 5, 6, 8 mm

BE-8257 SCREWDRIVER ERGO 1.6X8.0X175

BE-8255 SCREWDRIVER ERGO 1.2X6.5X150

BE-8242 SCREWDRIVER ERGO 1.0X6.5X150

BE-8040 SCREWDRIVER ERGO 0.8X4.0X100

BE-8030 SCREWDRIVER ERGO 0.6X3.5X75

BE-8611 SCREWDRIVER ERGO PH1X75

BE-8620 SCREWDRIVER ERGO PH2X100

BE-8910 SCREWDRIVER ERGO TX 15X100

BE-8915 SCREWDRIVER ERGO TX 15X100

BE-8920 SCREWDRIVER ERGO TX 20X100

BE-8925 SCREWDRIVER ERGO TX 25X125

BE-8927 SCREWDRIVER ERGO TX 27X125

BE-8930 SCREWDRIVER ERGO TX 30X150

BE-8940 SCREWDRIVER ERGO TX 40X150

BE-8577 SCREWDRIVER ERGO 1/4 BIT HOLDER

BE-8355 SCREWDRIVER ERGO 1.2X8.5X25

BE-8602 SCREWDRIVER ERGO PH2X75

25800-180 COMBINATION PUNCH 180 mm

2430 G-200 IP SNIPER NOSE CUTTING 200 mm

7224 SLIP JOINT PLIER 250 mm

2953-250 UNIVERSAL LOCKING CURVED PLIER 250 mm

2101G-160IP SIDE CUTTER 160 mm

479-16 BALL PEIN HAMMER

3625N-35 PLAIN HAMMER

MTB-3-16 3M TAPE MEASURE 16MM

SC127 ELECTRICIAN'S SCISSORS 127MM

BE-9678 BLACK KEYS SETS FOR HEX SCREWS, LONG BALL END 1.5, 2, 2.5, 3, 4, 5, 6, 8, 10

BE-9575 BLACK KEYS SETS FOR TORX SCREWS, LONG BALL END T9, 10, 15, 20, 25, 27, 30, 40





AUTO REPAIR SMALL COMPOSITION

FF1ASET-AUTO3

3 DRAWERS FILLED COMPOSITION. 140 TOOLS



- 4 inlays Small composition including:
 - 1/4 and 1/2 socket drivers
 - Combination wrenches
 - Slotted, PH and TORX screwdrivers
- Suitable for all vehicle garages
- Compatible with all trolleys



ERGO TOOL MANAGEMENT SYSTEM



AUTO SMALL COMPOSITION

- 111M COMBINATION WRENCH 6, 7, 8, 9, 10, 11, 12, 13, 14, 15, 16, 17, 18, 19, 21, 22, 24, 27, 30, 32 mm
- 7800SM SOCKET 1/2 10, 12, 13, 14, 15, 16, 17, 18, 19, 20, 21, 22, 23, 24, 27, 30, 32 mm
- 8154-1/2 T-HANDLE
- 8159-1/2 EXTENSION
- 8160-1/2 EXTENSION
- 8166-1/2 UNIVERSAL JOINT
- 8150SL RATCHET 1/2, SLIM HEAD 72T
- 6700SM 1/4 SOCKET 1/4 4, 4.5, 5, 5.5, 6, 7, 8, 9, 10, 11, 12, 13 mm
- 6954 T-HANDLE
- 6960 EXTENSION 1/4
- 6962 EXTENSION 1/4
- 6966 UNIVERSAL JOINT
- 59S/31-1 PZ1, PZ2 (x3), PZ3; PH1, PH2 (x3), PH3; PH2G (x2); T10, T15 (x3), T20 (x3), T25 (x2), T27, T30; SL: 3, 4, 5, 5.5mm; HEX: 3mm, 4, 5, 6mm. 1/4" Magnetic bit holder
- 6950SL RATCHET 1/4, SLIM HEAD 72T
- 3735-4-120 CENTRE PUNCH
- 3734 COTTER PIN PUNCH 2, 3, 4, 5, 6, 8 mm
- BE-8257 SCREWDRIVER ERGO 1.6X8,0X175
- BE-8255 SCREWDRIVER ERGO 1.2X6,5X150
- BE-8242 SCREWDRIVER ERGO 1,0X5,5X150
- BE-8040 SCREWDRIVER ERGO 0.8X4,0X100
- BE-8030 SCREWDRIVER ERGO 0.6X3,5X75
- BE-8611 SCREWDRIVER ERGO PH1X75



AUTO SMALL COMPOSITION

- BE-8620 SCREWDRIVER ERGO PH2X100
- BE-8910 SCREWDRIVER ERGO TX 10X75
- BE-8915 SCREWDRIVER ERGO TX 15X100
- BE-8920 SCREWDRIVER ERGO TX 20X100
- BE-8925 SCREWDRIVER ERGO TX 25X125
- BE-8927 SCREWDRIVER ERGO TX 27X125
- BE-8930 SCREWDRIVER ERGO TX 30X150
- BE-8940 SCREWDRIVER ERGO TX 40X150
- BE-8950 SCREWDRIVER ERGO TX 45X150
- BE-8355 SCREWDRIVER ERGO 1.2X6,5X25
- BE-8602 SCREWDRIVER ERGO PH2X25
- 2630D-180 COMBINATION PLIER 180 mm
- 2430 G-200 IP SNIPE NOSE CUTTING 200 mm
- 7224 SLIP JOINT PLIER 250 mm
- 2953-250 UNIVERSAL LOCKING CURVED PLIER 250 mm
- 2101 G-150MP SIDE CUTTER 150 mm
- 479-16 BALL PEIN HAMMER
- 3825N-35 PLASTIC HAMMER
- MTB-3-16 3M TAPE MEASURE 16MM
- SC127 ELECTRICIAN'S SCISSORS 127MM
- BE-9678 BLACK KEYS SETS FOR HEX SCREWS, LONG BALL END 1.5, 2, 2.5, 3, 4, 5, 6, 8, 10
- BE-9575 BLACK KEYS SETS FOR TORX SCREWS, LONG BALL END 19, 10, 16, 20, 25, 27, 30, 40





GENERAL INDUTRY HD RIGID CASE COMPOSITION

4750RCHDW02FF1

MRO composition in a HD Rigid Case

- MRO composition in a HD Rigid Case:
 - 1/4 and 1/2 socket drivers. Deep and standard
 - Combination wrenches
 - Slotted, PH and TORX screwdrivers
 - Bits covering all profiles
 - Pliers: Side Cutters, combination, snipe nose, slip joint pliers, etc
- Suitable for all MRO applications
- Hardware: 4750RCHDW02 HD Rigid Case with Wheels



ERGO TOOL MANAGEMENT SYSTEM

MRO COMPOSITION

111M COMBINATION WRENCH 6, 7, 8, 9, 10, 11, 12, 13, 14, 15, 16, 17, 18, 19, 20, 21, 22, 23, 24, 25, 26, 27, 28, 29, 30, 32 mm

1150-1/2H/P CALIPER 150MM

1177 SCRIBE OFFSET SCRIBER 230 mm

1544 FEELER GAUCHE

1RM RATCHET COMBINATION WRENCH 6, 7, 8, 9, 10, 11, 12, 13, 14, 15, 16, 17, 18, 19 mm

2058-BR BIT-RATCHET 1/4IN

2101G-160IP SIDE CUTTER 160 mm

2427 G-200 IP SNIPE NOSE BENT 200 mm

2430 G-200 IP SNIPE NOSE CUTTING 200 mm

2509 FLEX. PICK UP

2535F1 MAGNETIC PICK UP1 KGR

2628 G-160IP COMBINATION PLIER 160 mm

2820EF2 ELEC-KNIFE PLASTIC HNDLE 200MM

3625W-35 NYLON TIP MALLET 35 MM.

3734 COTTER PIN PUNCH 3, 5, 8

3735-4-120 CENTER PUNCH

481-300 GERMAN DIN-HAMMER

5515T-52 TELESCOPE MIRROR

59/S31 PZ1, PZ2 (x3), PZ3; PH1, PH2 (x3), PH3; PH2G (x2); T10, T15 (x3), T20 (x3), T25 (x2), T27 and T30. SL: 3, 4, 5, 5.5mm; HEX: 3mm, 4, 5, 6mm. 1/4" Magnetic bit holder.

6700SM SOCKET 1/4 6, 7, 8, 9, 10, 11, 12, 13 mm

6709M SOCKET DRIVER 1/4 HEX 3, 4, 5, 6, 8 mm

6709PH SOCKET DRIVER 1/4 PH 1, 2, 3

6709TORX SOCKET DRIVER 1/4 TORX 8, 9, 10, 15, 20, 25, 27, 30, 40 mm

6950SL RATCHET 1/4, SLIM HEAD 72T

6954 SPANNER

6956 SPINNER HANDLE 1/4

6958 BREAKER BAR

6960 EXTENSION 1/4 50 mm

6962 EXTENSION 1/4 150 mm

6962L EXTENSION BAR 1/4 355 mm

6966 UNIVERSAL JOINT

6972H TORX RATCHET HOLDER 1/4

7764 ADAPTOR 3/8 TO 1/4

7800SM SOCKET 1/2 6, 7, 8, 9, 10, 11, 12, 13, 14, 15, 16, 17, 18, 19, 21, 22, 23, 24, 25, 26, 27, 28, 30, 32 mm

7805SM SOCKET DEEP 1/2 10, 12, 13, 14, 15, 16, 17, 18, 19, 20, 21, 22, 23, 24, 25, 26, 27, 28, 29, 30, 32 mm

7809TORX SOCKET 1/2 TORX 25, 27, 30, 40, 45, 50 mm

8150RN-1/2 RATCHET 1/2 ROUND TYPE

8154-1/2 T HANDLE

8158-1/2 BREAKER BAR

8159-1/2 EXTENSION 75 mm

8160-1/2 EXTENSION 125 mm

8162-1/2 EXTENSION 250 mm

8166-1/2 UNIVERSAL JOINT

8224 IP SLIP JOINT PLIER 8224 250 mm

9070C ADJUSTABLE WRENCH 9070 C 6"

A6800DM SOCKET 1/4 AEROSPACE 6, 5, 6, 7, 8, 9, 10, 11, 12, 13

BE-8571 PH1, 2 PZ1, 2 and 5, 5 and 6, 5 slotted 100 mm blades with quick release SCD

BE-9770 BLACK KEYS SETS FOR HEX SCREWS, LONG BALL END 1.5, 2, 2.5, 3, 4, 5, 6, 8, 10 mm

BFLA01 Q3 LED TORCH

MTB-3-16 3M TAPE MEASURE 16 mm



GENERAL INDUSTRY AND VDE COMPOSITIONS

TO BE DEVELOPED UNDER REQUEST

GENERAL INDUSTRY COMPOSITION

- Two versions: general industry and VDE
- First drawer always standard composition
- Second drawer to be chosen between VDE or standard composition



ERGO TOOL MANAGEMENT SYSTEM

DRAWER 1 STANDARD RANGE

- 9031 ADJUSTABLE WRENCH 9031
- 9072 ADJUSTABLE WRENCH 9072 10"
- 7800SM SOCKET 1/2 8, 9, 10, 11, 12, 13, 14, 15, 16, 17, 18, 19, 21, 22, 23, 24, 25, 27, 28, 30, 32 mm
- 8155-1/2 RATCHET 1/2, ERGO
- 8160-1/2 EXTENSION
- 8162-1/2 EXTENSION BAR 250 MM
- 8154-1/2 T-HANDLE
- 8166-1/2 UNIVERSAL JOINT
- 7809M-6 SOCKET DRIVER 1/2, HEX 6, 8, 9, 10, 12
- 111M COMBINATION WRENCH 6, 7, 8, 9, 10, 11, 12, 13, 14, 15, 16, 17, 18, 19, 22, 24, 27, 30, 32 mm
- 225-PLUS HACKSAW FRAMES
- 208 HACKSAW FRAMES
- KERU-01 ERGO RETRACTABLE UTILITY KNIFE
- MTS-5-25 5M TAPE 25MM STAINLESS
- 481-500 GERMAN DIN-HAMMER

DRAWER 2 VDE VERSION

- 2101S-160 SIDE CUTTER 160 mm
- 2628 S-180 COMBINATION PLIER 180 mm
- 2430 S-200 SNIPE NOSE CUTTER 200 mm
- 2427 S-200 LONG NOSE PLIER 200 mm
- 8224CIP SLIP JOINT PLIER 250 mm
- BE-8220S SCREWDRIVER ERGO IEC 0,5X3,0X100
- BE-8040S SCREWDRIVER ERGO IEC 0,8X4,0X100
- BE-8050S SCREWDRIVER ERGO IEC 1,0X5,5X125
- BE-8060S SCREWDRIVER ERGO IEC 1,2X6,5X150
- BE-8065S SCREWDRIVER ERGO IEC 1,2X6,0X175
- BE-8610S SCREWDRIVER ERGO IEC PH1X80
- BE-8620S SCREWDRIVER ERGO IEC PH2X100
- BE-8340 SCREWDRIVER ERGO 0,8X4X25
- BE-8601 SCREWDRIVER ERGO PH1X25
- 8045LVDE VOLTAGE TESTER VDE 0,5X3,5X42
- BE-9777 SCREWDR SET HEX 2,5-10

DRAWER 2 MRO VERSION

- 2101GC-160IP SIDE CUTTER 160 mm
- 2628 GC-180IP COMBINATION PLIER 180 mm
- 2430 GC-200 IP SNIPE NOSE CUTTING CHROME 200 mm
- 2427 GC-200IP LONG ROUND NOSE CHROME 200 mm
- 8224CIP SLIP JOINT PLIER 250 mm
- BE-8020 SCREWDRIVER ERGO 0,5X3,0X100
- BE-8040 SCREWDRIVER ERGO 0,8X4,0X100
- BE-8150 SCREWDRIVER ERGO 1,0X5,5X100
- BE-8155 SCREWDRIVER ERGO 1,2X6,5X125
- BE-8601 SCREWDRIVER ERGO PH1X25
- BE-8602 SCREWDRIVER ERGO PH2X25
- BE-8220 SCREWDRIVER ERGO 0,5X3,0X125
- BE-8340 SCREWDRIVER ERGO 0,8X4X25
- BE-8601 SCREWDRIVER ERGO PH1X25
- 8045LVDE VOLTAGE TESTER VDE 0,5X3,5X42
- BE-9777 SCREWDR SET HEX 2,5-10





GENERAL INDUSTRY MECHANICAL

FF1A5002 + FF1A17 + FF1A03 MRO COMPOSITION FOR TROLLEYS



FF1A5002 - 27 pcs

- 111M-6 COMBINATION WRENCH
- 111M-7 COMBINATION WRENCH
- 111M-8 COMBINATION WRENCH
- 111M-9 COMBINATION WRENCH
- 111M-10 COMBINATION WRENCH
- 111M-11 COMBINATION WRENCH
- 111M-12 COMBINATION WRENCH
- 111M-13 COMBINATION WRENCH
- 111M-14 COMBINATION WRENCH
- 111M-15 COMBINATION WRENCH
- 111M-16 COMBINATION WRENCH
- 111M-17 COMBINATION WRENCH
- 111M-18 COMBINATION WRENCH
- 111M-19 COMBINATION WRENCH
- 111M-20 COMBINATION WRENCH
- 111M-21 COMBINATION WRENCH
- 111M-22 COMBINATION WRENCH
- 111M-24 COMBINATION WRENCH
- 111M-27 COMBINATION WRENCH
- 111M-30 COMBINATION WRENCH
- 111M-32 COMBINATION WRENCH
- 519-1570 COMBINATION WRENCH



FF1A17 - 61 pcs

- BE-9780 BLACK HEX KEYS SET, LONG BALL END, 12 PCS
0,050", 1/16", 5/64", 3/16", 1/4", 5/16", 3/8", 7/16", 1/2", 5/8", 3/4", 7/8", 1", 1 1/8", 1 1/4", 1 1/2", 1 3/4", 2", 2 1/4", 2 1/2", 3", 3 1/4", 3 1/2", 4", 4 1/4", 4 1/2", 5", 5 1/4", 5 1/2", 6", 6 1/4", 6 1/2", 7", 7 1/4", 7 1/2", 8", 8 1/4", 8 1/2", 9", 9 1/4", 9 1/2", 10", 10 1/4", 10 1/2", 11", 11 1/4", 11 1/2", 12", 12 1/4", 12 1/2", 13", 13 1/4", 13 1/2", 14", 14 1/4", 14 1/2", 15", 15 1/4", 15 1/2", 16", 16 1/4", 16 1/2", 17", 17 1/4", 17 1/2", 18", 18 1/4", 18 1/2", 19", 19 1/4", 19 1/2", 20", 20 1/4", 20 1/2", 21", 21 1/4", 21 1/2", 22", 22 1/4", 22 1/2", 23", 23 1/4", 23 1/2", 24", 24 1/4", 24 1/2", 25", 25 1/4", 25 1/2", 26", 26 1/4", 26 1/2", 27", 27 1/4", 27 1/2", 28", 28 1/4", 28 1/2", 29", 29 1/4", 29 1/2", 30", 30 1/4", 30 1/2", 31", 31 1/4", 31 1/2", 32", 32 1/4", 32 1/2", 33", 33 1/4", 33 1/2", 34", 34 1/4", 34 1/2", 35", 35 1/4", 35 1/2", 36", 36 1/4", 36 1/2", 37", 37 1/4", 37 1/2", 38", 38 1/4", 38 1/2", 39", 39 1/4", 39 1/2", 40", 40 1/4", 40 1/2", 41", 41 1/4", 41 1/2", 42", 42 1/4", 42 1/2", 43", 43 1/4", 43 1/2", 44", 44 1/4", 44 1/2", 45", 45 1/4", 45 1/2", 46", 46 1/4", 46 1/2", 47", 47 1/4", 47 1/2", 48", 48 1/4", 48 1/2", 49", 49 1/4", 49 1/2", 50", 50 1/4", 50 1/2", 51", 51 1/4", 51 1/2", 52", 52 1/4", 52 1/2", 53", 53 1/4", 53 1/2", 54", 54 1/4", 54 1/2", 55", 55 1/4", 55 1/2", 56", 56 1/4", 56 1/2", 57", 57 1/4", 57 1/2", 58", 58 1/4", 58 1/2", 59", 59 1/4", 59 1/2", 60", 60 1/4", 60 1/2
- BE-8020L / BE-8220 SLOTTED SCREWDRIVERS, ERGO™
0,5x3x75 mm, 0,5x3x125 mm
- BE-8150 / BE-8155 SLOTTED SCREWDRIVERS, ERGO™
1x5,5x100 mm, 1,2x6,5x125 mm
- BE-8260 SCREWDRIVER ERGO™
SLOTTED
1,6x8,8x175
- BE-8610 / BE-8620 / BE-8630 PHILLIPS SCREWDRIVERS, ERGO™
PH1X25 mm, PH2X25 mm
- PH1X25 mm, PH2X25 mm
- 2047-1-5.5 DOUBLE OFFSET KEY FOR SLOTTED SCREWS
1X5,5X125 mm
- 2047PR-1-2 DOUBLE OFFSET KEY FOR PHILLIPS SCREWS
PH1 & 2
- 706-2 PRECISION SCREWDRIVERS SET FOR SLOTTED & PHILLIPS SCREWS
1,0X50, 1,2X50, 1,5X50, 1,8X50 mm, PH0, PH0
- 2058-BR BIT RATCHET 1/4"
- 59/52R-A BITS SET FOR SLOTTED, PHILLIPS, TORX®, HEXAGON AND TORX® HEAD SCREWS
28 PCS
- BE-8350 SCREWDRIVER ERGO™
SLOTTED, SECURITY
1X5,5X25
- 808050 RATCHETING BIT SCREWDRIVER



FF1A03 - 18 pcs

- BE-9770 BLACK HEX KEYS SET, LONG BALL END, 9 PCS
1.5, 2, 2.5, 3, 4, 5, 6, 8, 10
- 2171G-160 SIDE CUTTER 160 mm
- 2678G-160 COMBINATION PLIER 160 mm
- 2971G-250 SLIP JOINT PLIER 250 mm
- 3734N DRIFT PUNCH 4x150, 6x150
- 481-400 DIN-HAMMER
- 306 HACKSAW FRAME AND SANDFLEX® BI-METAL BLADE
- 1-100-08-2 8" FLAT FILE, WITH HANDLE, SECOND
- MTG-5-19 5m TAPE MEASURE 19mm

TO OPEN
 1. PULL UP FLAP TO GRASP HANDLE OF LEVER.
 2. PULL LEVER HANDLE AND PULL LEVER NO. 1 FULLY DOWN.
 3. PULL UP FLAP NO. 2 FULLY DOWN.
 4. PULL LEVER NO. 2 FULLY DOWN.
 5. MAKE SURE THAT GREEN LIGHT IS ON.
 6. PRESS SELECTOR TO OPEN (AFTER DOOR IS COMPLETELY OPEN).
 7. MAKE SURE SELECTOR RETURNS TO NEUTRAL POSITION.
 8. CHECK FOLDING STRUT (SEE INSTRUCTIONS INSIDE).

TO CLOSE
 1. PULL UP FLAP FOR ACCESS TO CARGO DOOR CONTROL PANEL.
 2. PRESS SELECTOR TO CLOSE.
 3. UNTIL DOOR IS COMPLETELY CLOSED.
 4. PULL BACK LEVER NO. 2 IN ITS RECESS.
 5. PULL UP FLAP NO. 1 AND FEED IT BACK IN ITS RECESS.
 6. MAKE SURE GREEN LIGHT IS OFF AND BLUE LIGHT IS ON.
 7. DOOR IS LOCKED IN CLOSED POSITION AND SELECTOR RETURNS TO NEUTRAL POSITION.
 8. CLOSE FLAP (GIVING ACCESS TO CARGO DOOR CONTROL PANEL).

CAUTION
 IN CASE OF ACTUATOR FAILURE, DO NOT FORCE DOOR INTO OPEN OR CLOSE POSITION, BUT USE APPLICABLE PROCEDURE.

ACCESS TO CARGO DOOR CONTROL PANEL





GENERAL INDUSTRY BIG

FF1A3004 + FF1A2501 + FF1A4001 + FF1A1007 + FF1A12

MRO COMPOSITION FOR TROLLEYS



FF1A3004 - 30 pcs

- 111M-6 COMBINATION WRENCH
- 111M-7 COMBINATION WRENCH
- 111M-8 COMBINATION WRENCH
- 111M-9 COMBINATION WRENCH
- 111M-10 COMBINATION WRENCH
- 111M-11 COMBINATION WRENCH
- 111M-12 COMBINATION WRENCH
- 111M-13 COMBINATION WRENCH
- 111M-14 COMBINATION WRENCH
- 111M-15 COMBINATION WRENCH
- 111M-16 COMBINATION WRENCH
- 111M-17 COMBINATION WRENCH
- 111M-18 COMBINATION WRENCH
- 111M-19 COMBINATION WRENCH
- 111M-20 COMBINATION WRENCH
- 111M-21 COMBINATION WRENCH
- 111M-22 COMBINATION WRENCH
- 111M-24 COMBINATION WRENCH
- 1RM-8 RATCHET WRENCH
- 1RM-9 RATCHET WRENCH
- 1RM-10 RATCHET WRENCH
- 1RM-11 RATCHET WRENCH
- 1RM-12 RATCHET WRENCH
- 1RM-13 RATCHET WRENCH
- 1RM-14 RATCHET WRENCH
- 1RM-15 RATCHET WRENCH
- 1RM-16 RATCHET WRENCH
- 1RM-17 RATCHET WRENCH
- 1RM-18 RATCHET WRENCH
- 1RM-19 RATCHET WRENCH



FF1A4001 - 12 pcs

- 1520D POWER CUTTER 1520 D
- 2101G-160IP SIDE CUTTER 160 mm
- 2110G-200IP SIDE CUTTER 200 mm
- 2223G-150 STRIPPING PLIERS ERGO 150 mm
- 2421G-140IP FLAT NOSE PL LONG 140 mm
- 2421G-180IP FLAT NOSE PL 180 mm
- 2427G-200IP SNIPE NOSE BENT G 200 mm
- 2628G-180IP COMB PLIER 180 mm
- 2681 RIVET GUN
- 2951-140 CURVED JAWS CLEANER 140 mm
- 2951-300 GRIP HANDLE SIDE CUTTER 300 mm
- 3220IP SIDE CUTTER 200 mm

TO OPEN
 1. GRASP HANDLE OF LEVER AND PULL LEVER IN ITS RECESS.
 2. PULL LEVER IN ITS RECESS TO FULLY OPEN DOOR.
 3. MAKE SURE THAT GREEN LIGHT IS ON COMPLETELY.
 4. MAKE SURE SELECTOR RETURNS TO NEUTRAL POSITION COMPLETELY.
 5. LOCK FOLDING STRUT (SEE INSTRUCTIONS INSIDE).

TO CLOSE
 1. GRASP HANDLE OF LEVER AND PULL LEVER IN ITS RECESS TO FULLY OPEN DOOR.
 2. PULL LEVER IN ITS RECESS TO FULLY OPEN DOOR.
 3. MAKE SURE THAT GREEN LIGHT IS ON COMPLETELY.
 4. MAKE SURE SELECTOR RETURNS TO NEUTRAL POSITION COMPLETELY.
 5. LOCK FOLDING STRUT (SEE INSTRUCTIONS INSIDE).

CAUTION
 IN CASE OF ACTUATOR FAILURE, DO NOT FORCE DOOR INTO OPEN OR CLOSE POSITION, BUT USE APPLICABLE PROCEDURE.

ACCESS TO CARGO DOOR CONTROL PANEL





GENERAL INDUSTRY BIP

■ **FF1A3004 + FF1A2501 + FF1A4001**
FF1A1007 + FF1A12
MRO COMPOSITION FOR TROLLEYS



FF1A1007 - 63 pcs

- 2510 WORKSHOP MIRROR
- 5468-112 TWEEZER 5468-112
- 5471F-145 TWEEZER 5471 F-145
- 59/531 IMPACT BITS SET 31PCS
- BE-8040 SCREW.DR ERGO 0,8 X 4,0 X 100
- BE-8158 SCREW.DR ERGO 1,0 X 5,5 X 125
- BE-8159 SCREW.DR ERGO 1,2 X 6,5 X 150
- BE-8220 SCREW.DR ERGO 0,5 X 3,0 X 125
- BE-8340 SCREW.DR ERGO 0,8 X 4 X 25
- BE-8601 SCREW.DR ERGO PH1 X 25
- BE-8628 SCREW.DR ERGO PH1 X 100
- BE-8629 SCREW.DR ERGO PH2 X 125
- BE-8865 SCREW.DR ERGO T6 X 5,0 X 175
- BE-8906 SCREW.DR ERGO TX 6 X 50
- BE-8907 SCREW.DR ERGO TX 7 X 55
- BE-8908 SCREW.DR ERGO TX 8 X 60
- BE-8909 SCREW.DR ERGO TX 9 X 60
- BE-8910 SCREW.DR ERGO TX 10 X 65
- BE-8915 SCREW.DR ERGO TX 15 X 70
- BE-8920 SCREW.DR ERGO TX 20 X 80
- BE-8925 SCREW.DR ERGO TX 25 X 80
- BE-8930 SCREW.DR ERGO TX 30 X 100
- BE-9770 SCREW.DR SET HEX 1,5-10
- TL124-SA TWEEZER 124-SA



FF1A12 - 19 pcs

- 481-300 / 481-500 DIN HAMMER
300, 500 mm
- 3625W-35 NYLON 3625 HAMMER
- 8156-1/2 BREAKER BAR 380 mm
- 2509 FLEXIBLE PICK-UP TOOL 525 mm
- 2535F2 MAGNETIC PICK-UP TOOL 1 kg
- 3734 DRIFT PUNCHES
Ø 3, 5, 8 mm
- 3735-4-120 CENTRE PUNCH
120 mm
- 3740-150 FLAT CHISEL
150 mm
- 3745-150 BALL CHISEL
150 mm
- 1-100-06-1-2 6" FLAT FILE
WITH HANDLE, BASTARD
- 1-100-06-2-2 6" FLAT FILE,
WITH HANDLE, SECOND
- 1-160-06-1-2 6" SQUARE FILE
WITH HANDLE, BASTARD
- 1-210-06-1-2 6" HALF ROUND FILE,
WITH HANDLE, BASTARD
- 1-230-06-1-2 6" ROUND FILE, WITH HANDLE, BASTARD
- FS-8 SCISSORS
- 319 HACKSAW FRAME AND
BI METAL SANDELEX® BLADE

TO OPEN

- 1. GRASP HANDLE OF FLAP AND PULL LEVER NO. 1 FULLY DOWN
- 2. GRASP HANDLE OF FLAP AND PULL LEVER NO. 2 FULLY DOWN
- 3. GRASP HANDLE OF FLAP AND PULL LEVER NO. 3 FULLY DOWN
- 4. GRASP HANDLE OF FLAP AND PULL LEVER NO. 4 FULLY DOWN
- 5. GRASP HANDLE OF FLAP AND PULL LEVER NO. 5 FULLY DOWN
- 6. GRASP HANDLE OF FLAP AND PULL LEVER NO. 6 FULLY DOWN
- 7. GRASP HANDLE OF FLAP AND PULL LEVER NO. 7 FULLY DOWN
- 8. GRASP HANDLE OF FLAP AND PULL LEVER NO. 8 FULLY DOWN
- 9. GRASP HANDLE OF FLAP AND PULL LEVER NO. 9 FULLY DOWN
- 10. GRASP HANDLE OF FLAP AND PULL LEVER NO. 10 FULLY DOWN
- 11. GRASP HANDLE OF FLAP AND PULL LEVER NO. 11 FULLY DOWN
- 12. GRASP HANDLE OF FLAP AND PULL LEVER NO. 12 FULLY DOWN
- 13. GRASP HANDLE OF FLAP AND PULL LEVER NO. 13 FULLY DOWN
- 14. GRASP HANDLE OF FLAP AND PULL LEVER NO. 14 FULLY DOWN
- 15. GRASP HANDLE OF FLAP AND PULL LEVER NO. 15 FULLY DOWN
- 16. GRASP HANDLE OF FLAP AND PULL LEVER NO. 16 FULLY DOWN
- 17. GRASP HANDLE OF FLAP AND PULL LEVER NO. 17 FULLY DOWN
- 18. GRASP HANDLE OF FLAP AND PULL LEVER NO. 18 FULLY DOWN
- 19. GRASP HANDLE OF FLAP AND PULL LEVER NO. 19 FULLY DOWN
- 20. GRASP HANDLE OF FLAP AND PULL LEVER NO. 20 FULLY DOWN
- 21. GRASP HANDLE OF FLAP AND PULL LEVER NO. 21 FULLY DOWN
- 22. GRASP HANDLE OF FLAP AND PULL LEVER NO. 22 FULLY DOWN
- 23. GRASP HANDLE OF FLAP AND PULL LEVER NO. 23 FULLY DOWN
- 24. GRASP HANDLE OF FLAP AND PULL LEVER NO. 24 FULLY DOWN
- 25. GRASP HANDLE OF FLAP AND PULL LEVER NO. 25 FULLY DOWN
- 26. GRASP HANDLE OF FLAP AND PULL LEVER NO. 26 FULLY DOWN
- 27. GRASP HANDLE OF FLAP AND PULL LEVER NO. 27 FULLY DOWN
- 28. GRASP HANDLE OF FLAP AND PULL LEVER NO. 28 FULLY DOWN
- 29. GRASP HANDLE OF FLAP AND PULL LEVER NO. 29 FULLY DOWN
- 30. GRASP HANDLE OF FLAP AND PULL LEVER NO. 30 FULLY DOWN
- 31. GRASP HANDLE OF FLAP AND PULL LEVER NO. 31 FULLY DOWN
- 32. GRASP HANDLE OF FLAP AND PULL LEVER NO. 32 FULLY DOWN
- 33. GRASP HANDLE OF FLAP AND PULL LEVER NO. 33 FULLY DOWN
- 34. GRASP HANDLE OF FLAP AND PULL LEVER NO. 34 FULLY DOWN
- 35. GRASP HANDLE OF FLAP AND PULL LEVER NO. 35 FULLY DOWN
- 36. GRASP HANDLE OF FLAP AND PULL LEVER NO. 36 FULLY DOWN
- 37. GRASP HANDLE OF FLAP AND PULL LEVER NO. 37 FULLY DOWN
- 38. GRASP HANDLE OF FLAP AND PULL LEVER NO. 38 FULLY DOWN
- 39. GRASP HANDLE OF FLAP AND PULL LEVER NO. 39 FULLY DOWN
- 40. GRASP HANDLE OF FLAP AND PULL LEVER NO. 40 FULLY DOWN
- 41. GRASP HANDLE OF FLAP AND PULL LEVER NO. 41 FULLY DOWN
- 42. GRASP HANDLE OF FLAP AND PULL LEVER NO. 42 FULLY DOWN
- 43. GRASP HANDLE OF FLAP AND PULL LEVER NO. 43 FULLY DOWN
- 44. GRASP HANDLE OF FLAP AND PULL LEVER NO. 44 FULLY DOWN
- 45. GRASP HANDLE OF FLAP AND PULL LEVER NO. 45 FULLY DOWN
- 46. GRASP HANDLE OF FLAP AND PULL LEVER NO. 46 FULLY DOWN
- 47. GRASP HANDLE OF FLAP AND PULL LEVER NO. 47 FULLY DOWN
- 48. GRASP HANDLE OF FLAP AND PULL LEVER NO. 48 FULLY DOWN
- 49. GRASP HANDLE OF FLAP AND PULL LEVER NO. 49 FULLY DOWN
- 50. GRASP HANDLE OF FLAP AND PULL LEVER NO. 50 FULLY DOWN
- 51. GRASP HANDLE OF FLAP AND PULL LEVER NO. 51 FULLY DOWN
- 52. GRASP HANDLE OF FLAP AND PULL LEVER NO. 52 FULLY DOWN
- 53. GRASP HANDLE OF FLAP AND PULL LEVER NO. 53 FULLY DOWN
- 54. GRASP HANDLE OF FLAP AND PULL LEVER NO. 54 FULLY DOWN
- 55. GRASP HANDLE OF FLAP AND PULL LEVER NO. 55 FULLY DOWN
- 56. GRASP HANDLE OF FLAP AND PULL LEVER NO. 56 FULLY DOWN
- 57. GRASP HANDLE OF FLAP AND PULL LEVER NO. 57 FULLY DOWN
- 58. GRASP HANDLE OF FLAP AND PULL LEVER NO. 58 FULLY DOWN
- 59. GRASP HANDLE OF FLAP AND PULL LEVER NO. 59 FULLY DOWN
- 60. GRASP HANDLE OF FLAP AND PULL LEVER NO. 60 FULLY DOWN
- 61. GRASP HANDLE OF FLAP AND PULL LEVER NO. 61 FULLY DOWN
- 62. GRASP HANDLE OF FLAP AND PULL LEVER NO. 62 FULLY DOWN
- 63. GRASP HANDLE OF FLAP AND PULL LEVER NO. 63 FULLY DOWN

TO CLOSE

- 1. GRASP HANDLE OF FLAP AND PULL LEVER NO. 1 FULLY UP
- 2. GRASP HANDLE OF FLAP AND PULL LEVER NO. 2 FULLY UP
- 3. GRASP HANDLE OF FLAP AND PULL LEVER NO. 3 FULLY UP
- 4. GRASP HANDLE OF FLAP AND PULL LEVER NO. 4 FULLY UP
- 5. GRASP HANDLE OF FLAP AND PULL LEVER NO. 5 FULLY UP
- 6. GRASP HANDLE OF FLAP AND PULL LEVER NO. 6 FULLY UP
- 7. GRASP HANDLE OF FLAP AND PULL LEVER NO. 7 FULLY UP
- 8. GRASP HANDLE OF FLAP AND PULL LEVER NO. 8 FULLY UP
- 9. GRASP HANDLE OF FLAP AND PULL LEVER NO. 9 FULLY UP
- 10. GRASP HANDLE OF FLAP AND PULL LEVER NO. 10 FULLY UP
- 11. GRASP HANDLE OF FLAP AND PULL LEVER NO. 11 FULLY UP
- 12. GRASP HANDLE OF FLAP AND PULL LEVER NO. 12 FULLY UP
- 13. GRASP HANDLE OF FLAP AND PULL LEVER NO. 13 FULLY UP
- 14. GRASP HANDLE OF FLAP AND PULL LEVER NO. 14 FULLY UP
- 15. GRASP HANDLE OF FLAP AND PULL LEVER NO. 15 FULLY UP
- 16. GRASP HANDLE OF FLAP AND PULL LEVER NO. 16 FULLY UP
- 17. GRASP HANDLE OF FLAP AND PULL LEVER NO. 17 FULLY UP
- 18. GRASP HANDLE OF FLAP AND PULL LEVER NO. 18 FULLY UP
- 19. GRASP HANDLE OF FLAP AND PULL LEVER NO. 19 FULLY UP
- 20. GRASP HANDLE OF FLAP AND PULL LEVER NO. 20 FULLY UP
- 21. GRASP HANDLE OF FLAP AND PULL LEVER NO. 21 FULLY UP
- 22. GRASP HANDLE OF FLAP AND PULL LEVER NO. 22 FULLY UP
- 23. GRASP HANDLE OF FLAP AND PULL LEVER NO. 23 FULLY UP
- 24. GRASP HANDLE OF FLAP AND PULL LEVER NO. 24 FULLY UP
- 25. GRASP HANDLE OF FLAP AND PULL LEVER NO. 25 FULLY UP
- 26. GRASP HANDLE OF FLAP AND PULL LEVER NO. 26 FULLY UP
- 27. GRASP HANDLE OF FLAP AND PULL LEVER NO. 27 FULLY UP
- 28. GRASP HANDLE OF FLAP AND PULL LEVER NO. 28 FULLY UP
- 29. GRASP HANDLE OF FLAP AND PULL LEVER NO. 29 FULLY UP
- 30. GRASP HANDLE OF FLAP AND PULL LEVER NO. 30 FULLY UP
- 31. GRASP HANDLE OF FLAP AND PULL LEVER NO. 31 FULLY UP
- 32. GRASP HANDLE OF FLAP AND PULL LEVER NO. 32 FULLY UP
- 33. GRASP HANDLE OF FLAP AND PULL LEVER NO. 33 FULLY UP
- 34. GRASP HANDLE OF FLAP AND PULL LEVER NO. 34 FULLY UP
- 35. GRASP HANDLE OF FLAP AND PULL LEVER NO. 35 FULLY UP
- 36. GRASP HANDLE OF FLAP AND PULL LEVER NO. 36 FULLY UP
- 37. GRASP HANDLE OF FLAP AND PULL LEVER NO. 37 FULLY UP
- 38. GRASP HANDLE OF FLAP AND PULL LEVER NO. 38 FULLY UP
- 39. GRASP HANDLE OF FLAP AND PULL LEVER NO. 39 FULLY UP
- 40. GRASP HANDLE OF FLAP AND PULL LEVER NO. 40 FULLY UP
- 41. GRASP HANDLE OF FLAP AND PULL LEVER NO. 41 FULLY UP
- 42. GRASP HANDLE OF FLAP AND PULL LEVER NO. 42 FULLY UP
- 43. GRASP HANDLE OF FLAP AND PULL LEVER NO. 43 FULLY UP
- 44. GRASP HANDLE OF FLAP AND PULL LEVER NO. 44 FULLY UP
- 45. GRASP HANDLE OF FLAP AND PULL LEVER NO. 45 FULLY UP
- 46. GRASP HANDLE OF FLAP AND PULL LEVER NO. 46 FULLY UP
- 47. GRASP HANDLE OF FLAP AND PULL LEVER NO. 47 FULLY UP
- 48. GRASP HANDLE OF FLAP AND PULL LEVER NO. 48 FULLY UP
- 49. GRASP HANDLE OF FLAP AND PULL LEVER NO. 49 FULLY UP
- 50. GRASP HANDLE OF FLAP AND PULL LEVER NO. 50 FULLY UP
- 51. GRASP HANDLE OF FLAP AND PULL LEVER NO. 51 FULLY UP
- 52. GRASP HANDLE OF FLAP AND PULL LEVER NO. 52 FULLY UP
- 53. GRASP HANDLE OF FLAP AND PULL LEVER NO. 53 FULLY UP
- 54. GRASP HANDLE OF FLAP AND PULL LEVER NO. 54 FULLY UP
- 55. GRASP HANDLE OF FLAP AND PULL LEVER NO. 55 FULLY UP
- 56. GRASP HANDLE OF FLAP AND PULL LEVER NO. 56 FULLY UP
- 57. GRASP HANDLE OF FLAP AND PULL LEVER NO. 57 FULLY UP
- 58. GRASP HANDLE OF FLAP AND PULL LEVER NO. 58 FULLY UP
- 59. GRASP HANDLE OF FLAP AND PULL LEVER NO. 59 FULLY UP
- 60. GRASP HANDLE OF FLAP AND PULL LEVER NO. 60 FULLY UP
- 61. GRASP HANDLE OF FLAP AND PULL LEVER NO. 61 FULLY UP
- 62. GRASP HANDLE OF FLAP AND PULL LEVER NO. 62 FULLY UP
- 63. GRASP HANDLE OF FLAP AND PULL LEVER NO. 63 FULLY UP

CAUTION

- 1. IN CASE OF ACTUATOR FAILURE, DO NOT FORCE DOOR INTO OPEN OR CLOSE POSITION, BUT USE APPLICABLE PROCEDURE.

ACCESS TO CARGO DOOR CONTROL PANEL





GENERAL INDUSTRY BIG

FF1A3004 + FF1A2501 + FF1A4001 + FF1A1007 + FF1A12

MRO COMPOSITION FOR TROLLEYS



FF1A2501 - 83 pcs

- 6700SM-4 SOCKET 1/4
- 6700SM-5 SOCKET 1/4
- 6700SM-5.5 SOCKET 1/4
- 6700SM-6 SOCKET 1/4
- 6700SM-7 SOCKET 1/4
- 6700SM-8 SOCKET 1/4
- 6700SM-9 SOCKET 1/4
- 6700SM-10 SOCKET 1/4
- 6700SM-11 SOCKET 1/4
- 6700SM-12 SOCKET 1/4
- 6700SM-13 SOCKET 1/4
- 6700TORX-E9 SOCKET 1/4
- 6700TORX-E10 SOCKET 1/4
- 6709M-3 SOCKET 1/4
- 6709M-4 SOCKET 1/4
- 6709M-5 SOCKET 1/4
- 6709M-6 SOCKET 1/4
- 6709M-8 SOCKET 1/4
- 6709TORX-T8 SOCKET 1/4
- 6709TORX-T10 SOCKET 1/4
- 6709TORX-T11 SOCKET 1/4
- 6709TORX-T20 SOCKET 1/4
- 6709TORX-T25 SOCKET 1/4
- 6709TORX-T27 SOCKET 1/4
- 6709TORX-T30 SOCKET 1/4
- 6709TORX-T40 SOCKET 1/4
- 6950SL RATCHET 1/4, SLIM HEAD 72T

- 6954 T-HANDLE 1/4
- 6956 NUT DRIVER 1/4
- 6962 EXTENSION 1/4
- 6966 UNIVERSAL JOINT 1/4
- 7400SM-8 SOCKET 3/8
- 7400SM-9 SOCKET 3/8
- 7400SM-10 SOCKET 3/8
- 7400SM-11 SOCKET 3/8
- 7400SM-12 SOCKET 3/8
- 7400SM-13 SOCKET 3/8
- 7400SM-14 SOCKET 3/8
- 7400SM-15 SOCKET 3/8
- 7400SM-16 SOCKET 3/8
- 7400SM-17 SOCKET 3/8
- 7400SM-19 SOCKET 3/8
- 7400SM-20 SOCKET 3/8
- 7400SM-21 SOCKET 3/8
- 7400SM-22 SOCKET 3/8
- 7400TORX-E8 SOCKET 3/8
- 7400TORX-E10 SOCKET 3/8
- 7400TORX-E12 SOCKET 3/8
- 7400TORX-E14 SOCKET 3/8
- 7754 T-HANDLE 3/8
- 7762 EXTENSION 3/8
- 7764 ADAPTOR 3/8
- 7765 ADAPTOR 3/8

- 7766 UNIVERSAL JOINT
- 7768 SMOOTH OPERATION U.JOINT- 3/8
- 7800SM-12 SOCKET 1/2
- 7800SM-13 SOCKET 1/2
- 7800SM-17 SOCKET 1/2
- 7800SM-18 SOCKET 1/2
- 7800SM-19 SOCKET 1/2
- 7800SM-20 SOCKET 1/2
- 7800SM-21 SOCKET 1/2
- 7800SM-22 SOCKET 1/2
- 7800SM-24 SOCKET 1/2
- 7800SM-27 SOCKET 1/2
- 7800SM-30 SOCKET 1/2
- 7800SM-32 SOCKET 1/2
- 7809M-10 SOCKET 1/2
- 7809M-12 SOCKET 1/2
- 7809TORX-T20 SOCKET 1/2
- 7809TORX-T25 SOCKET 1/2
- 7809TORX-T40 SOCKET 1/2
- 7809TORX-T50 SOCKET 1/2
- 7809TORX-T55 SOCKET 1/2
- 8150SL RATCHET 1/2, SLIM HEAD 72T
- 8154-1/2 T-HANDLE 1/2
- 8162-1/2 EXTENSION 1/2
- 8164-1/2 ADAPTOR 1/2
- 8166-1/2 ADAPTOR 1/2
- 8166-1/2 UNIVERSAL JOINT 1/2
- 8964 ADAPTOR 1/2

TO OPEN

- 1. GRASP FLAP TO GRASP HANDLE AND PULL LEVER NO. 1 TO FULLY OPEN POSITION.
- 2. GRASP HANDLE AND PULL LEVER NO. 2 FULLY DOWN.
- 3. GRASP FLAP FOR ACCESS TO CARGO DOOR CONTROL PANEL.
- 4. MAKE SURE THAT GREEN LIGHT IS ON.
- 5. PRESS SELECTOR TO OPEN (A/B/C DOOR).
- 6. MAKE SURE SELECTOR RETURNS TO NEUTRAL POSITION COMPLETELY.
- 7. MAKE SURE HANDLE OF LEVER NO. 1 AND PULL LEVER NO. 2 ARE IN FULLY OPEN POSITION (SEE INSTRUCTIONS INSIDE).

TO CLOSE

- 1. GRASP FLAP FOR ACCESS TO CARGO DOOR CONTROL PANEL.
- 2. OPEN FLAP FOR ACCESS TO CARGO DOOR CONTROL PANEL.
- 3. PRESS SELECTOR TO CLOSE.
- 4. UNTIL DOOR IS COMPLETELY CLOSED.
- 5. PULL BACK LEVER NO. 2 IN ITS RECESS.
- 6. GRASP HANDLE OF LEVER NO. 1 AND FEED IT BACK IN ITS RECESS.
- 7. MAKE SURE GREEN LIGHT IS OFF AND BLUE LIGHT IS ON.
- 8. DOOR IS LOCKED IN CLOSED POSITION AND SELECTOR RETURNS TO NEUTRAL POSITION.
- 9. CLOSE FLAP GIVING ACCESS TO CARGO DOOR CONTROL PANEL.

CAUTION

- IN CASE OF ACTUATOR FAILURE, DO NOT FORCE DOOR INTO OPEN OR CLOSE POSITION, BUT USE APPLICABLE PROCEDURE.

ACCESS TO CARGO DOOR CONTROL PANEL





GENERAL INDUSTRY INC

FF1A14 + FF1A13 + FF1A4001 + FF1A1007 + FF1A12 MRO COMPOSITION FOR TROLLEYS



FF1A13 - 82 pcs

A6800Z SOCKETS 1/4" BI-HEX, AEROSPACE LONG SERIES
3/16", 7/32", 1/4", 9/32", 5/16", 11/32", 3/8", 7/16", 1/2",
9/16"

A6800M SOCKETS 1/4", AEROSPACE LONG SERIES
4, 10"

6700SZ-5/32 SOCKET 1/4", SHORT SERIES

A6700Z SOCKETS 1/4" BI-HEX, AEROSPACE SHORT SERIES
3/16", 7/32", 1/4", 9/32", 5/16", 11/32", 3/8", 7/16", 1/2",
9/16"

A6700Z SWIVEL SOCKETS 1/4", BI-HEX, AEROSPACE
3/16", 7/32", 1/4", 9/32", 5/16", 11/32", 3/8", 7/16", 1/2",
9/16"

6966 UNIVERSAL JOINT 1/4"

6950SL REVERSING RATCHET 1/4", SLIMHEAD

6958 BREAKER BAR 1/4"

6954 T-HANDLE 1/4"

6956 SPINNER HANDLE 1/4"

6960 / 6961 / 6962 / 6962L EXTENSION BARS 1/4"
50, 100, 150, 200 mm

A7400BZ SOCKET 3/8" BI-HEX, AEROSPACE SHORT SERIES
1/4", 5/16", 3/8", 7/16", 1/2", 17/32", 9/16", 19/32", 5/8",
11/16", 3/4", 13/16", 7/8"

A7400BZ SOCKETS 3/8", BI-HEX, LONG SERIES, AEROSPACE
1/4", 5/16", 3/8", 7/16", 1/2", 9/16", 5/8", 19/32", 11/16",
1 1/8", 1 1/4", 1 1/2", 1 3/4", 2"

6958 BREAKER BAR 3/8"

7766 UNIVERSAL JOINT 3/8"

7750SL RATCHET 3/8", SLIMHEAD

7758 BREAKER BAR 3/8"

7754 T-HANDLE 3/8"

7752 SPEEDER 3/8"

7760 / 7761 / 7762 EXTENSION BARS 3/8"
75, 125, 250 mm

7764 ADAPTOR F 3/8" - M 1/4"

7765 ADAPTOR F 1/4" - M 3/8"

8165-1/2 ADAPTOR F 1/2" - M 3/8"

8164-1/2 ADAPTOR F 3/8" - M 1/2"

6972H BIT HOLDER 1/4"

7407H BIT HOLDER 3/8" 1/4" - 3/8"

7408H BIT HOLDER 3/8" - 5/16" - 3/8"

S6106KA SOCKET SPARK PLUG 7/8"



FF1A14 - 43 pcs

111Z COMBINATION WRENCHES

1/4", 5/16", 3/8", 7/16", 1/2", 9/16", 5/8", 11/16", 3/4",
13/16", 7/8", 15/16", 1"

1952Z 11/32 COMBINATION WRENCH
11/32"

1320R RATCHETING RING WRENCHES

1/4X5/16", 5/16X1/32", 3/8X7/16", 1/2X9/16"

1950MZ 3/8 CROWFOOT ADJUSTABLE WRENCH 3/8"

8009 C/F ADJUSTABLE CHROMED WRENCH 1/4" 110X13 mm

9070C ADJUSTABLE WRENCH CHROMED 6" ERGO

156x20 mm

1931Z LILIPUT DOUBLE OPEN-END WRENCHES

5/32", 3/16", 7/32", 1/4", 9/32", 5/16", 11/32", 3/8", 7/16",
1/2", 9/16"

6Z DOUBLE OPEN-END WRENCHES

1/4X5/16", 5/16X11/32", 3/8X7/16 1/2X9/16"

19/32X11/16", 5/8X3/4", 25/32X13/16", 7/8", 15/16",

15/16X1", 1X1.125", 1.1/16X1.1/4"

TO OPEN
 1. PULL UP FLAP TO GRASP HANDLE OF PRESS SELECTOR
 2. PULL PRESS HANDLE AND PULL LEVER NO 2 FULLY DOWN
 3. PULL UP FLAP NO 2 FULLY DOWN
 4. PULL PRESS HANDLE TO OPEN (AFTER DOOR IS COMPLETELY OPEN (AFTER DOOR IS COMPLETELY OPEN (AFTER DOOR IS COMPLETELY OPEN)
 5. MAKE SURE SELECTOR RETURNS TO NEUTRAL POSITION (SEE INSTRUCTIONS INSIDE)
 6. CHECK FOLDING STRUT (SEE INSTRUCTIONS INSIDE)

TO CLOSE
 1. PULL UP FOLDING STRUT (SEE INSTRUCTIONS INSIDE)
 2. OPEN FLAP FOR ACCESS TO CARGO DOOR CONTROL PANEL
 3. PRESS SELECTOR TO CLOSE
 4. UNTIL DOOR IS COMPLETELY CLOSED
 5. PULL BACK LEVER NO 2 IN ITS RECESS
 6. PULL UP FLAP NO 2 AND FEED IT BACK IN ITS RECESS
 7. MAKE SURE GREEN LIGHT IS OFF AND BLUE LIGHT IS ON
 8. DOOR IS LOCKED IN CLOSED POSITION
 9. RETURNS TO NEUTRAL POSITION
 10. CLOSE FLAP (GIVING ACCESS TO CARGO DOOR CONTROL PANEL)

CAUTION
 IN CASE OF ACTUATOR FAILURE, DO NOT FORCE DOOR INTO OPEN OR CLOSE POSITION, BUT USE APPLICABLE PROCEDURE.

ACCESS TO CARGO DOOR CONTROL PANEL



FF1A4001 - 12 pcs

1520D POWER CUTTER 1520 D

2101G-160IP SIDE CUTTER 160 mm

21HDG-200IP ERGO SIDE CUTTERHD 200 mm

2223G-150 STRIPPING PLIERS ERGO 150 mm

2421G-140IP FLAT NOSE PL LONG 140 mm

2421G-180IP FLAT NOSE PL 180 mm

2427G-200IP SNIPE NOSE BENT G 200 mm

2628G-180IP COMB PLIER 180 mm

2681 RIVET GUN

2951-140 CURVED JAWS CLAMP 140 mm

2951-300 GRIP WITH WIRE CUTTER 300 mm

6224IP SLIP JOINT PLIER 250 mm

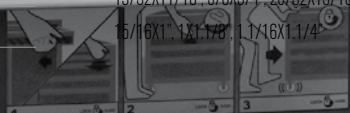



GENERAL INDUSTRY INCHES

FF1A14 + FF1A13 + FF1A4001 + FF1A1007 + FF1A12 MRO COMPOSITION FOR TROLLEYS



FF1A1007 - 63 pcs

- 2510 WORKSHOP MIRROR
- 5468-112 TWEEZER 5468-112
- 5471F-145 TWEEZER 5471 F-145
- 597531 IMPACT BITS SET 31PCS
- BE-8040 SCREW.DR ERGO 0,8 X 4,0 X 100
- BE-8158 SCREW.DR ERGO 1,0 X 5,5 X 125
- BE-8159 SCREW.DR ERGO 1,2 X 6,5 X 150
- BE-8220 SCREW.DR ERGO 0,5 X 3,0 X 125
- BE-8340 SCREW.DR ERGO 0,8 X 4 X 25
- BE-8601 SCREW.DR ERGO PH1 X 25
- BE-8628 SCREW.DR ERGO PH1 X 100
- BE-8629 SCREW.DR ERGO PH2 X 125
- BE-8865 SCREW.DR ERGO TX 6 X 50
- BE-8906 SCREW.DR ERGO TX 6 X 50
- BE-8907 SCREW.DR ERGO TX 7 X 55
- BE-8908 SCREW.DR ERGO TX 8 X 60
- BE-8909 SCREW.DR ERGO TX 9 X 60
- BE-8910 SCREW.DR ERGO TX 10 X 65
- BE-8915 SCREW.DR ERGO TX 15 X 70
- BE-8920 SCREW.DR ERGO TX 20 X 80
- BE-8925 SCREW.DR ERGO TX 25 X 80
- BE-8930 SCREW.DR ERGO TX 30 X 100
- BE-9770 SCREW.DR SET HEX 1,5-10
- TL124-SA TWEEZER 124-SA



FF1A12 - 19 pcs

- 481-300 / 481-500 DIN HAMMER
- 300, 500mm
- 3625W-35 NYLON 3625 HAMMER
- 8156-1/2 BREAKER BAR 380 mm
- 2509 FLEXIBLE PICK-UP TOOL 525 mm
- 2535F2 MAGNETIC PICK-UP TOOL 1 kg
- 3734 DRIFT PUNCHES
- Ø 3, 5, 8 mm
- 3735-4-120 CENTRE PUNCH
- 120 mm
- 3740-150 FLAT CHISEL
- 150 mm
- 3745-150 BALL CHISEL
- 150 mm
- 1-100-06-1-2 6" FLAT FILE
- WITH HANDLE, BASTARD
- 1-100-06-2-2 6" FLAT FILE,
- WITH HANDLE, SECOND
- 1-160-06-1-2 6" SQUARE FILE
- WITH HANDLE, BASTARD
- 1-210-06-1-2 6" HALF ROUND FILE,
- WITH HANDLE, BASTARD
- 1-230-06-1-2 6" ROUND FILE, WITH HANDLE, BASTARD
- FS-8 SCISSORS
- 319 HACKSAW FRAME AND
- BI METAL SANDELEX® BLADE

TO OPEN
 1. GRASP HANDLE OF UPPER FLAP AND PULL LEVER NO 1 FULLY DOWN.
 2. GRASP HANDLE OF LOWER FLAP AND PULL LEVER NO 2 FULLY DOWN.
 3. GRASP HANDLE OF UPPER FLAP AND PULL LEVER NO 3 FULLY DOWN.
 4. GRASP HANDLE OF LOWER FLAP AND PULL LEVER NO 4 FULLY DOWN.
 5. MAKE SURE THAT GREEN LIGHT IS ON.
 6. PRESS SELECTOR TO OPEN (AFTER DOOR IS COMPLETELY OPEN).
 7. MAKE SURE SELECTOR RETURNS TO NEUTRAL POSITION.
 8. CHECK FOLDING STRUT (SEE INSTRUCTIONS INSIDE).

TO CLOSE
 1. GRASP FOLDING STRUT (SEE INSTRUCTIONS INSIDE).
 2. OPEN FLAP FOR ACCESS TO CARGO DOOR CONTROL PANEL.
 3. PRESS SELECTOR TO CLOSE.
 4. UNTIL DOOR IS COMPLETELY CLOSED.
 5. PULL BACK LEVER NO 2 IN ITS RECESS.
 6. DEPRESS HANDLE OF LEVER NO 1 AND FEEL IT BACK IN ITS RECESS.
 7. MAKE SURE GREEN LIGHT IS OFF AND BLUE LIGHT IS ON.
 8. DOOR IS LOCKED IN CLOSED POSITION AND SELECTOR RETURNS TO NEUTRAL POSITION.
 9. CLOSE FLAP GIVING ACCESS TO CARGO DOOR CONTROL PANEL.

CAUTION
 IN CASE OF ACTUATOR FAILURE, DO NOT FORCE DOOR INTO OPEN OR CLOSE POSITION, BUT USE APPLICABLE PROCEDURE.

ACCESS TO CARGO DOOR CONTROL PANEL





GENERAL INDUSTRY VDE

FF1A3004 + FF1A5009 + FF1A03 MRO COMPOSITION FOR TROLLEYS



FF1A3004 - 30 pcs

- 111M-6 COMBINATION WRENCH
- 111M-7 COMBINATION WRENCH
- 111M-8 COMBINATION WRENCH
- 111M-9 COMBINATION WRENCH
- 111M-10 COMBINATION WRENCH
- 111M-11 COMBINATION WRENCH
- 111M-12 COMBINATION WRENCH
- 111M-13 COMBINATION WRENCH
- 111M-14 COMBINATION WRENCH
- 111M-15 COMBINATION WRENCH
- 111M-16 COMBINATION WRENCH
- 111M-17 COMBINATION WRENCH
- 111M-18 COMBINATION WRENCH
- 111M-19 COMBINATION WRENCH
- 111M-20 COMBINATION WRENCH
- 111M-21 COMBINATION WRENCH
- 111M-22 COMBINATION WRENCH
- 111M-24 COMBINATION WRENCH
- 1RM-8 RATCHET WRENCH
- 1RM-9 RATCHET WRENCH
- 1RM-10 RATCHET WRENCH
- 1RM-11 RATCHET WRENCH
- 1RM-12 RATCHET WRENCH
- 1RM-13 RATCHET WRENCH
- 1RM-14 RATCHET WRENCH
- 1RM-15 RATCHET WRENCH
- 1RM-16 RATCHET WRENCH
- 1RM-17 RATCHET WRENCH
- 1RM-18 RATCHET WRENCH
- 1RM-19 RATCHET WRENCH



FF1A5009 - 17 pcs

- 2101S-160 SIDE CUTTER 160 mm
- 2223S-150 STRIPPING PLIER 150 mm
- 2250M 1000V SIDE CUTTER 1000V 8D
- 2430S-200 LONG NOSE PLIER 200 mm
- 2628S-180 COMB PLIER 180 mm
- 8072V ADJUSTABLE WRENCH 1000V 10"
- BE-8220S SCREW.DR ERGO IEC 0.5 X 3.0 X 100
- BE-8040S SCREW.DR ERGO IEC 0.8 X 4.0 X 100
- BE-8140 SCREW.DR ERGO IEC 0.8 X 4 X 25
- BE-8050S SCREW.DR ERGO IEC 1.0 X 5.5 X 125
- BE-8255S SCREW.DR ERGO IEC 1.2 X 6.5 X 150
- BE-8601 SCREW.DR ERGO PH2 X 26
- BE-8610S SCREW.DR ERGO IEC PH1 X 75
- BE-8620S SCREW.DR ERGO IEC PH2 X 100
- BE-8810S SCREW.DR ERGO IEC PZ1 X 75
- BE-8820S SCREW.DR ERGO IEC PZ2 X 100



FF1A03 - 18 pcs

- BE-9770 BLACK HEX KEYS SET, LONG BALL END, 9 PCS
1.5, 2, 2.5, 3, 4, 5, 6, 8, 10
- 2171G-160 SIDE CUTTER 160 mm
- 2678G-160 COMBINATION PLIER 160 mm
- 2971G-250 SLIP JOINT PLIER 250 mm
- 3734N DRIFT PUNCH 4x150, 6x150
- 481-400 DIN-HAMMER
- 306 HACKSAW FRAME AND SANDFLEX® BI-METAL BLADE
- 1-100-08-2 8" FLAT FILE, WITH HANDLE, SECOND
- MTG-5-19 5m TAPE MEASURE 19mm

TO OPEN
 1. PULL UP FLAP TO GRASP HANDLE OF DOOR LEVER AND PULL LEVER IN ITS RECESS
 2. PULL LEVER FULLY DOWN
 3. PULL UP FLAP FOR ACCESS TO CARGO DOOR CONTROL PANEL
 4. MAKE SURE GREEN LIGHT IS ON
 5. PRESS SELECTOR TO OPEN (AFTER DOOR IS COMPLETELY OPEN)
 6. MAKE SURE SELECTOR RETURNS TO NEUTRAL POSITION
 7. CHECK FOLDING STRUT (SEE INSTRUCTIONS INSIDE)

TO CLOSE
 1. PULL UP FLAP FOR ACCESS TO CARGO DOOR CONTROL PANEL
 2. PRESS SELECTOR TO CLOSE
 3. UNTIL DOOR IS COMPLETELY CLOSED
 4. PULL BACK LEVER IN ITS RECESS
 5. PULL UP FLAP AND FEED IT BACK IN ITS RECESS
 6. MAKE SURE GREEN LIGHT IS OFF AND BLUE LIGHT IS ON
 7. DOOR LOCKED IN CLOSED POSITION
 8. RETURNS TO NEUTRAL POSITION
 9. CLOSE FLAP (GIVING ACCESS TO CARGO DOOR CONTROL PANEL)

CAUTION
 IN CASE OF ACTUATOR FAILURE, DO NOT FORCE DOOR INTO OPEN OR CLOSE POSITION, BUT USE APPLICABLE PROCEDURE

ACCESS TO CARGO DOOR CONTROL PANEL







WINDPOWER COMPOSITIONS

4750RCHDW02FF2

Windpower General Purpose Composition

- Windpower compositions developed together with Danish Windpower Academy. It has been specifically developed for repair and maintenance of Siemenes and Vestas Windmills
- Includes two boxes. Standard box with daily hand tools like wrenches, sockets 1/2, pliers, screwdrivers and lanyards. A Heavy Duty Box with special tools to be used in certain applications
- Hardware: 4750RCHDW02



ERGO TOOL MANAGEMENT SYSTEM



STANDARD BOX

4750RCHDW02 HD Rigid Case

Inlay 01 FOAM W/ SOCKETS 3/8-1/4

6700SM-5.5 SOCKET 1/4

6700SM-6 SOCKET 1/4

6700SM-7 SOCKET 1/4

6700SM-8 SOCKET 1/4

6700SM-9 SOCKET 1/4

6700SM-10 SOCKET 1/4

6700SM-11 SOCKET 1/4

6700SM-12 SOCKET 1/4

6700SM-13 SOCKET 1/4

6954 T-HANDLE

6956 SPINNER HANDLE 1/4

6958 BREAKER BAR

6960 EXTENSION 1/4 50MM

6961 EXTENSION 1/2

6962 EXTENSION 3/4

6962L EXTENSION BAR 1/4

6966 UNIVERSAL JOINT

6972H POWER SOCKET HOLDER 1/4

6950SL RATCHET 1/4, SLIM HEAD 72T

8158-1/2 BREAKER BAR

7800SM-10 SOCKET 1/2

7800SM-11 SOCKET 1/2

7800SM-12 SOCKET 1/2

7800SM-13 SOCKET 1/2

7800SM-14 SOCKET 1/2

7800SM-15 SOCKET 1/2

7800SM-16 SOCKET 1/2

7800SM-17 SOCKET 1/2

7800SM-18 SOCKET 1/2

7800SM-19 SOCKET 1/2

7800SM-21 SOCKET 1/2

7800SM-22 SOCKET 1/2

7800SM-24 SOCKET 1/2

7800SM-27 SOCKET 1/2

7800SM-30 SOCKET 1/2

7800SM-32 SOCKET 1/2

7809M-5 SOCKET DRIVER 1/2, HEX 5

7809M-6 SOCKET DRIVER 1/2, HEX 6

7809M-7 SOCKET DRIVER 1/2, HEX 7

7809M-8 SOCKET DRIVER 1/2, HEX 8

7809M-10 SOCKET DRIVER 1/2, HEX 10

7809M-12 SOCKET DRIVER 1/2, HEX 12

7809M-14 SOCKET DRIVER 1/2, HEX 14

7809M-17 SOCKET DRIVER 1/2, HEX

7809M-18 SOCKET DRIVER 1/2, HEX

7809TORX-T45 SOCKET 1/2

7809TORX-T45 SOCKET 1/2

7809TORX-T50 SOCKET 1/2

7809TORX-T55 SOCKET 1/2

7809TORX-T60 SOCKET 1/2

8150SL RATCHET 1/2, SLIM HEAD 72T

8154-1/2 T HANDLE 1/2

8160-1/2 EXTENSION 1/2

8162-1/2 EXTENSION 1/2

8165-1/2 ADAPTOR 1/2

8166-1/2 UNIVERSAL JOINT 1/2

Inlay 02 FOAM W/ WRENCHES

111M-6 OPEN END WRENCH

111M-7 OPEN END WRENCH

111M-8 OPEN END WRENCH

111M-9 OPEN END WRENCH

111M-10 COMBINATION WRENCH

111M-11 COMBINATION WRENCH

111M-12 COMBINATION WRENCH

111M-13 COMBINATION WRENCH

111M-14 COMBINATION WRENCH

111M-15 COMBINATION WRENCH

111M-16 COMBINATION WRENCH

111M-17 COMBINATION WRENCH

111M-18 COMBINATION WRENCH

111M-19 COMBINATION WRENCH

111M-21 COMBINATION WRENCH

111M-22 COMBINATION WRENCH

111M-24 COMBINATION WRENCH

111M-27 COMBINATION WRENCH

111M-30 COMBINATION WRENCH

111M-32 COMBINATION WRENCH

Inlay 03 FOAM W/ WRENCHES

BE-9770 SCREW DR SET HEX 1.5-10

1177-SCRIBE OPEN END WRENCH

6M-6-7 COMBINATION WRENCH

6M-8-9 COMBINATION WRENCH

6M-10-11 OPEN END WRENCH

6M-12-13 OPEN END WRENCH

6M-14-15 OPEN END WRENCH

6M-16-17 ADJUSTABLE WRENCH 9070 6"

6M-18-19 ADJUSTABLE WRENCH 9072

6M-20-22 OFFSET SCRIBER 230 MM

6M-24-27 COMBINATION WRENCH

6M-30-32 COMBINATION WRENCH



WINDPOWER COMPOSITIONS

4750RCHDW02FF2

Windpower General Purpose Composition

- Windpower compositions developed together with Danish Windpower Academy. It has been specifically developed for repair and maintenance of Siemenes and Vestas Windmills
- Includes two boxes. Standard box with daily hand tools like wrenches, sockets 1/2, pliers, screwdrivers and lanyards. A Heavy Duty Box with special tools to be used in certain applications
- Hardware: 4750RCHDW02



ERGO TOOL MANAGEMENT SYSTEM



STANDARD BOX

MTB-3-16-E 3M TAPE MEASURE 16MM ENGLISH

9070 OPEN END WRENCH

9072 OPEN END WRENCH

Inlay 04 FOAM W/ SCREWDRIVERS

BE-8020L SCREW.DR ERGO 0.5X3X7BE-8040

BE-8030 SCREW.DR ERGO 0.6X3.5X75

BE-8155 SCREW.DR ERGO 1.2X6.5X125

BE-8260 SCREW.DR ERGO 1.6X8.0X175

BE-8610 SCREW.DR ERGO PH1X75

BE-8620 SCREW.DR ERGO PH2X100

BE-8630 SCREW.DR ERGO PH3X150

BE-8810 SCREW.DR ERGO PZ1X150

BE-8820 SCREW.DR ERGO PZ2X150

BE-8830 SCREW.DR ERGO PZ3X150

1544 FEELER GAUCHE

2047-0-8-4 SCREWDR OFFSET 2047 PH 1-2

2047PR-1-2 SCREWDR OFFSET 2047 PH 1-2

2058-BR BIT-RATCHET 1/4IN

2509 FLEX. PICK UP

59S/31-1 BITS SET 31PCS PH,PZ,T,HEX,SL

808050P PISTOL HANDLE RATCHETING SCREW

808050S STUBBY RATCHETING SCREWDR.

BE-8220S SCREWDRIVER INSULATED

BE-8040S SCREW DRIVER INSULATED

BE-8050S SCREWDRIVER INSULATED

BE-8610S SCREWDRIVER INSULATED

BE-8620S SCREWDRIVER INSULATED

2535F2 MAGNETIC PICK UP1 KGR SMALL

Inlay 05 FOAM W/ PLIERS

1150-1/2H/P CALIPEP 150MM

2101G-160IP SIDE CUTTER 2101GC 160

2107-G-200 IP LONG ROUND NOSE CHROMED PL 200

2108-G-200 IP SHORE NOSE CUTTING CHROME 200

2628 G-160IP COMB PLIER CHROMED 160IP

2820EF2 ELEC. KNIFE PLASTIC HANDLE 200MM

5515T-52 TELESCOPE MIRROR

8224 IP SHIP JOINT PLIER8224CIP W/OCA

BF-LAD1 Q3 LED-TORCH

3623W-35 NYLON TIP MALLET 35 MM.

3734-3 CUTTER PIN PUNCH

3734-5 CUTTER PIN PUNCH

3734-8 CUTTER PIN PUNCH

3785-49320 CENTRE PUNCH

667-300 GERMAN DIN-HAMMER

3680 PRY BAR

Inlay 6 SPECIAL COMPARTMENT

3875-RL1 Retractable Lanyard X 4 UNITS

3875-WLT Wrist Lanyard

4750-3PB-2 3 Pocket Belt

2535L Magnetic Extendable pick up tool



WINDPOWER COMPOSITIONS

4750RCHDW02FF3

Windpower General Purpose Composition

- Windpower compositions developed together with Danish Windpower Academy. It has been specifically developed for repair and maintenance of Siemenes and Vestas Windmills
- Includes two boxes. Standard box with daily hand tools like wrenches, sockets 1/2, pliers, screwdrivers and lanyards. A Heavy Duty Box with special tools to be used in certain applications
- Hardware: 4750RCHDW02



ERGO TOOL MANAGEMENT SYSTEM



HEAVY DUTY BOX

4750RCHDW02 HD Rigid Case BIG

BE64520CH Oil Filter Tool

3625PU-50 Dead Hammer

489-1100 Hammer

1-473-08-2-2 File set

7444SG-M-36 Flogging Spanner

7444SG-M-41 Flogging Spanner

7444SG-M-46 Flogging Spanner

7444SG-M-50 Flogging Spanner

7444SG-M-55 Flogging Spanner

7452-100 Torque wrench 10-100

7455-340 Torque wrench 70-340

7452-1 Head for torque Wrench

7852-1 Head for torque Wrench

7452-7-13 OPEN END WRENCH

7452-7-17 OPEN END WRENCH

7452-7-19 OPEN END WRENCH

7452-8-13 OPEN END WRENCH

7452-8-17 OPEN END WRENCH

7452-8-19 OPEN END WRENCH

7852-8-24 Ring Wrench

7852-8-30 Ring Wrench

7764 3/8 - 1/4 Converter piece

8164-1/2 3/8 - 1/2 Converter piece

1952M-36 COMBINATION WRENCH

1952M-46 COMBINATION WRENCH

8900SM-27 3/4 SOCKET

8900SM-30 3/4 SOCKET

8900SM-32 3/4 SOCKET

8900SM-36 3/4 SOCKET

8900SM-38 3/4 SOCKET

8900SM-41 3/4 SOCKET

8900SM-46 3/4 SOCKET

8900SM-50 3/4 SOCKET

8962N 3/4 SOCKET ACCESSORIES

8961 3/4 SOCKET ACCESSORIES

1952M-50 COMBINATION WRENCH





**4750FB5ATS001 / 4750FB5BFF1 /
4750FB3-12TS100**

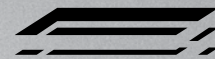

ERGO TOOL MANAGEMENT SYSTEM

4750FB5ATS001

4750FB5A TOOL CASE

2058/S2626 PIECE BIT SET

808050 RATCHETING SCREWDRIVER

80708" ADJUSTABLE WRENCH

2101G-160 160 MM SIDE CUTTER

2628G-180 180 MM COMBINATION PLIER

4750FB5BFF1

4750FB5B TOOL CASE

808050P-59/S31 PISTOL RATCHETING SCREWDRIVER

WITH 31 PIECE BIT SET

90708" ADJUSTABLE WRENCH

MTB-5-255M TAPE 25MM MAGNETIC

2101G-160 160 MM SIDE CUTTER

2628G-180 180MM COMBINATION PLIER

BE-9578 HEXAGON KEY SET

4750FB3-12TS100 Electrician Tool Kit

4750FB3-12 12" ELECTRICIAN BAG-HARD BOTTOM

2101G-180 SIDE CUTTER 2101G-180

2628G-200 COMB PLIER 200MM

2233D-160 STRIPPING/CUTTING PLIERS

268 MINI HACKSAW FRAMES

2144 MULTI PURPOSE KNIFE

BE-8510 SSCREW.DR ERGO IEC COMBI PH1X80

BE-8520S SCREW.DR ERGO IEC COMBI PH2X100

BE-8710S SCREW.DR ERGO IEC COMBI PZ1X80

BE-8720S SCREW.DR ERGO IEC COMBI PZ2X100

806-1-1 MAINS TESTER 3X65150-250V

60/B 01TERMINAL PLIER YELLOW 220 MM

MTB-5-25 5M TAPE 25MM MAGNETIC



4750FB4-18TS001 / 4750FB2W-TS00 / 4750FB2-19TS001

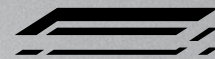

ERGO TOOL MANAGEMENT SYSTEM

4750FB4-18TS001 Service Engineers Tool Kit

4750FB4-18 LAPTOP&TOOLS BAG-HARD BOTTOM

2101G-160 SIDE CUTTER 2101G-160IP

2628G-180 COMBINATION PLIER

2430 G-160 SNIP NOSE CUTTING 160

1RM/SH8 RATCHET COMBINATION WRENCH SET

7223SLIP JOINT PLIER

2233D-200 CABLE CUTTER

SL251/4" DRIVE SOCKET SET

90706" ADJUSTABLE WRENCH

9031 ADJUSTABLE WRENCH

483-20 JOINER HAMMER

BE-8020 SCREW.DR ERGO 0.5X3.0X60

BE-8040 SCREW.DR ERGO 0.8X4.0X100

BE-8150 SCREW.DR ERGO 1.0X5.5X100

BE-8155 SCREW.DR ERGO 1.2X6.5X125

BE-8610 SCREW.DR ERGO PH1X75

BE-8620 SCREW.DR ERGO PH2X100

SC127 ELECTRICIAN'S SCISSORS 127MM

SQZ150003 SQUEEZE KNIFE

BE-9777 SCREW.DR SET HEX 2.5-10

MTB-5-25 5M TAPE 25MM MAGNETIC

4750FB2W-TS001 Service Engineers Tool Kit

4750FB2W-24A RIGID CASE ON WHEELS-POUCHES

S240 SOCKET SET 1/2"

SL25 SOCKET SET 1/4"

BE-8030 SCREW.DR ERGO 0.6X3.5X75

BE-8242 SCREW.DR ERGO 1.0X5.5X150

BE-8155 SCREW.DR ERGO 1.2X6.5X125

BE-8600 SCREW.DR ERGO PH0X60

BE-8610 SCREW.DR ERGO PH1X75

BE-8620 SCREW.DR ERGO PH2X100

BE-8800 SCREW.DR ERGO PZ0X60

BE-8810 SCREW.DR ERGO PZ1X75

BE-8820 SCREW.DR ERGO PZ2X100

BE-8040S SCREW.DR ERGO IEC 0.8X4.0X100

2628G-180 COMB PLIER 2628G-180

2101G-180 SIDE CUTTER 2101G-180v

7224 SLIP JOINT PLIER 7224

1520 G POWER CUTTER 1520 G

MTB-5-25 5M TAPE 25MM MAGNETIC

MA421 AVIAT.SNIP STRAUCUT 250MM

268 MINI HACKSAW FRAMES

32512" ERGO HACKSAW FRAME

479-16 BALL PEIN HAMMER

KERU-01 ERGO RETRACTABLE UTILITY KNIFE

BFLA01 Q3 LED TORCH W/ FOCUS

5515T TELESCOPIC MIRROR

9071 ADJUSTABLE WRENCH 9071 8"

4750FB2-19TS001 Service Maintenance Tool Kit

4750FB2-19A 19" CLOSED BAG-HARD BOTTOM

BE-8010S SCREW.DR ERGO IEC 0.4X2.5X75

BE-8040S SCREW.DR ERGO IEC 0.8X4.0X100

BE-8050S SCREW.DR ERGO IEC 1.0X5.5X125

BE-8220S SCREW.DR ERGO IEC 0.5X3.0X100

BE-8610S SCREW.DR ERGO IEC PH1X80

BE-8620S SCREW.DR ERGO IEC PH2X100

BE-8630S SCREW.DR ERGO IEC PH3X150

BE-8800S SCREW.DR ERGO IEC PZ0X60

BE-8820S SCREW.DR ERGO IEC PZ2X100

BE-8830S SCREW.DR ERGO IEC PZ3X150

706-4 PRECISION SCREDDRIVER SET

PC-12-VENVENEER SAW PROCUT

1-210-08-2-28" 1/2 ROUND.WITH HANDLE.CUT 2

2101G-180 SIDE CUTTER 2101G-180v

2233 D-200 CUTTING/STRIPPING PLIERS

2628G-180 COMB PLIER 2628 G-180

268 MINI HACKSAW FRAME

3830-20-VIP HOLESAWS SANDFLEX

3830-25-VIP HOLESAWS SANDFLEX

3834-ARBR-730 ARBOR

4130 DIAGONAL CUTTER 4130

424P-16 CHISEL 424P-16 MM

424P-20 CHISEL 424P-20 MM

424P-25 CHISEL 424P-25 MM

428-16 CLAW HAMMER FIBREGLASS-SHAFT

484-1250 CLUB HAMMER

806-1-T MAINS TESTER 3X65150-250V

8231 SLIP JOINT PLIER 225MM

9031 ADJUSTABLE WRENCH 9031

SL251/4" DRIVE SOCKET SET



1470K SERIES

26 INCHES TROLLEYS

- Suitable for Modular System
- Available in Orange, red, blue and black
- From 5 drawers to 8 drawers in any color
- Can be developed in any RAL color



Round key locking system. Strong keys and locking mechanism.



Click/detent closing system at the end of slides. This prevents the drawers from opening when moving.



Double wall frame. Drawers and slides work even if the frame gets damaged.



Drawer dimensions: Hx543x445 mm. Storage capacity: 0.157m³



Heavy duty construction with strong reinforcement in key areas. Total static load capacity: 600 kg



Long ball bearing slides. 100% opening drawers. Load capacity per drawer: 30 kg



Wheels 30x125 mm, ball bearings, 2 fixed and 2 swivel with brake. Good stability, easy to move and secure. Non marking rubber.

1470K7COLORS

1470K SERIES 26 INCHES TROLLEYS

- Suitable for Modular System.
- Available in Orange, red, blue and black
- From 5 drawers to 8 drawers in any color
- Can be developed in any RAL color



RANGE OF 26" TROLLEYS

CODE	DESCRIPTION
1470K5	5 DR TROLLEY-ORANGE RAL2009
1470K6	6 DR TROLLEY-ORANGE RAL2009
1470K7	7 DR TROLLEY-ORANGE RAL2009
1470K8	8 DR TROLLEY-ORANGE RAL2009
1470K5BLACK	5 DR TROLLEY-BLACK RAL9005
1470K6BLACK	6 DR TROLLEY-BLACK RAL9005
1470K7BLACK	7 DR TROLLEY-BLACK RAL9005
1470K8BLACK	8 DR TROLLEY-BLACK RAL9005
1470K5RED	5 DR TROLLEY-RED RAL3001
1470K6RED	6 DR TROLLEY-RED RAL3001
1470K7RED	7 DR TROLLEY-RED RAL3001
1470K8RED	8 DR TROLLEY-RED RAL3001
1470K5BLUE	5 DR TROLLEY-BLUE RAL5002
1470K6BLUE	6 DR TROLLEY-BLUE RAL5002
1470K7BLUE	7 DR TROLLEY-BLUE RAL5002
1470K8BLUE	8 DR TROLLEY-BLUE RAL5002
1480K4	4 DRAWERS TOP CHEST- ORANGE
1470K6YELLOW	6 DR TROLLEY-YELLOW RAL1023
1470KXL6C	XL W/CABINET 6DR ORANGE
1470KXL6CBLACK	XL W/CABINET 6DR BLACK

ACCESSORIES

CODE	DESCRIPTION
1470K-ACTD	26" MDF TOP
1470K-ACTW	26" WOODEN TOP
1470K-ACTSS	26" STAINLESS STEEL TOP
1470KXL-ACTD	40" MDF TOP
1470KXL-ACTW	40" WOODEN TOP
1470KXL-ACTSS	40" STAINLESS STEEL TOP
1470K-AC7	26" TOP W/CAVITIES ON LEFT
1470K-AC1	FOLDABLE TRAY X 1470 & 1475
1470K-AC2	PRY BAR/SD BOX x 1470K & 1475K
1470K-AC3	CAN HOLDER X 1470K & 1475K
1470K-AC4	DOC HOLDER X 1470K & 1475K
1470K-A-SIDE	SLOTS & DOTS SIDE PANEL
1470KAC01	DRAWER LINERS SET-7 UNITS
1470K-AC7	26" TOP W/CAVITIES ON LEFT

SPARE PARTS

CODE	DESCRIPTION
1470K-01	SLIDES (X2) 30KG CAPACITY
1470K-02	SWIVEL WHEELS (X2) 125X30MM
1470K-03	FIXED WHEELS (X2) 125X30MM
1470K-04001	LOCK & 2 KEYS OF 001 LOCK COMBINATION
1470K-04002	LOCK & 2 KEYS OF 002 LOCK COMBINATION
1470K-04200	LOCK & 2 KEYS OF 200 LOCK COMBINATION
1470K-05	HANDLE X 1470/75K SERIES
1470K-06	TOP MAT X 26" TROLLEYS

1475K SERIES 40 INCHES TROLLEYS

- Suitable for Modular System.
- Available in multiple colors: Orange, red, blue (dark and soft), green, purple and black
- From 5 drawers to 8 drawers in any color
- Can be developed in any RAL color



Drawers
Ball bearing slides
Full opening drawers.
A load capacity of 45 kg per drawer.



WOODEN
TOP

SNAWT1470 (26" trolleys)
SSNAWT1475 (40" trolleys)



RUBBER
TOP



STAINLESS
STEEL TOP



LOCKING
SYSTEM
Central Locking System with
tubular keys.
More than 210
keys available.



LOCK & GO!
The Lock & Go system
secures the drawers
automatically when
closed.



Aluminium
Brushed Handles
Easy to clean,
lightweight handles.



Double
Wall Frame
Drawers and slides function
as normal even if the frame
gets damaged.



Enhanced
Precision Wheels
Robust wheels, two fixed and two swivelling with
brakes. Good stability, easy to move and secure
with non marking rubber.

Dimensions:
125 x 50 mm (26" trolleys)
150 x 50 mm (40" trolleys)

1470KXL7COLORS



1475K SERIES 40 INCHES TROLLEYS

- Suitable for Modular System
- Available in multiple colors: Orange, red, blue (dark and soft), green, purple and black
- From 5 drawers to 8 drawers in any color
- Can be developed in any RAL color



RANGE OF 26" AND 40" TROLLEYS

CODE	DESCRIPTION
1475K8PAW	8 PRO TOOL TROLLEY MIKA GREEN
1475K8PC	8 DRAW.PRO TOOL TROLLEY BLACK
1475K8PCM	8 PRO TOOL TROLLEY ROYALBLUE
1475K8PDG	8 PRO TOOL TROLLEY MIDNIGHTBLUE
1475K8PEV	8 PRO TOOL TROLLEY PURPLE
1475K8PJJ	8 PRO TOOL TROLLEY EXTREME GREEN
1475K8PSP	8 DRAW.PRO TOOL TROLLEY ORANGE
1475K8PSV	8 PRO TOOL TROLLEY CARMINERED
1475KXL12PAW	12DR XL TROLLEY MIKA GREEN
1475KXL12PC	12DR XL TROLLEY BLACK
1475KXL12PCM	12DR XL TROLLEY ROYALBLUE
1475KXL12PDG	12DR XL TROLLEY MIDNIGHTBLUE
1475KXL12PEV	12DR XL TROLLEY PURPLE
1475KXL12PJJ	12DR XL TROLLEY EXTREME GREEN
1475KXL12PSP	12DR XL TROLLEY ORANGE
1475KXL12PSV	12DR XL TROLLEY RED
1475KXL6PAW	XL6 PRO TOOL TROLLEY MIKAGREEN

RANGE OF 40" TROLLEYS

CODE	DESCRIPTION
1475KXL6PC	XL6 DRAWERS P TOOL TROLLEY BLACK
1475KXL6PCM	XL6 PRO TOOL TROLLEY ROYALBLUE
1475KXL6PDG	XL6 PRO T TROLLEY MIDNIGHTBLUE
1475KXL6PEV	XL6 PRO TOOL TROLLEY PURPLE
1475KXL6PJJ	XL6 PRO T TROLLEY EXTREMEGREEN
1475KXL6PSP	XL6 PRO TOOL TROLLEY ORANGE
1475KXL6PSV	XL6 P TOOL TROLLEY CARMINERED
1475KXL7PAW	XL7 PRO TOOL TROLLEY MIKAGREEN
1475KXL7PC	XL7 PRO TOOL TROLLEY BLACK
1475KXL7PCM	XL7 PRO TOOL TROLLEY ROYALBLUE
1475KXL7PDG	XL7 PRO T TROLLEY MIDNIGHTBLUE
1475KXL7PEV	XL7 PRO TOOL TROLLEY PURPLE
1475KXL7PJJ	XL7 PRO T TROLLEY EXTREMEGREEN
1475KXL7PSP	XL7 PRO TOOL TROLLEY ORANGE
1475KXL7PSV	XL7 P TOOL TROLLEY CARMINERED

ACCESSORIES

CODE	DESCRIPTION
1470K-ACTD	26" MDF TOP
1470K-ACTW	26" WOODEN TOP
1470K-ACTSS	26" STAINLESS STEEL TOP
1470KXL-ACTD	40" MDF TOP
1470KXL-ACTW	40" WOODEN TOP
1470KXL-ACTSS	40" STAINLESS STEEL TOP
1470K-AC1	FOLDABLE TRAY X 1470 & 1475
1470K-AC2	PRY BAR/SD BOX x 1470K & 1475K
1470K-AC3	CAN HOLDER X 1470K & 1475K
1470K-AC4	DOC HOLDER X 1470K & 1475K
1470K-ACSIDE	SLOTS & DOTS SIDE PANEL
1470KAC01	DRAWER LINERS SET-7 UNITS

SPARE PARTS

CODE	DESCRIPTION
1475K-01	SLIDES (X2) 45KG CAPACITY
1475K-02	SWIWEL WHEELS (X2) 125X50MM
1475K-03	FIXED WHEELS (X2) 125X50MM
1475K-08	LOCK & GO LATCH X 26" - 1PC
1475K-081	LOCK & GO LATCH X 40" - 1PC
1475K-082	LOCK & GO LATCH X 11" - 1PC
1475KXL-02	SWIWEL WHEELS (X2) 150X50MM
1475KXL-03	FIXED WHEELS (X2) 150X50MM

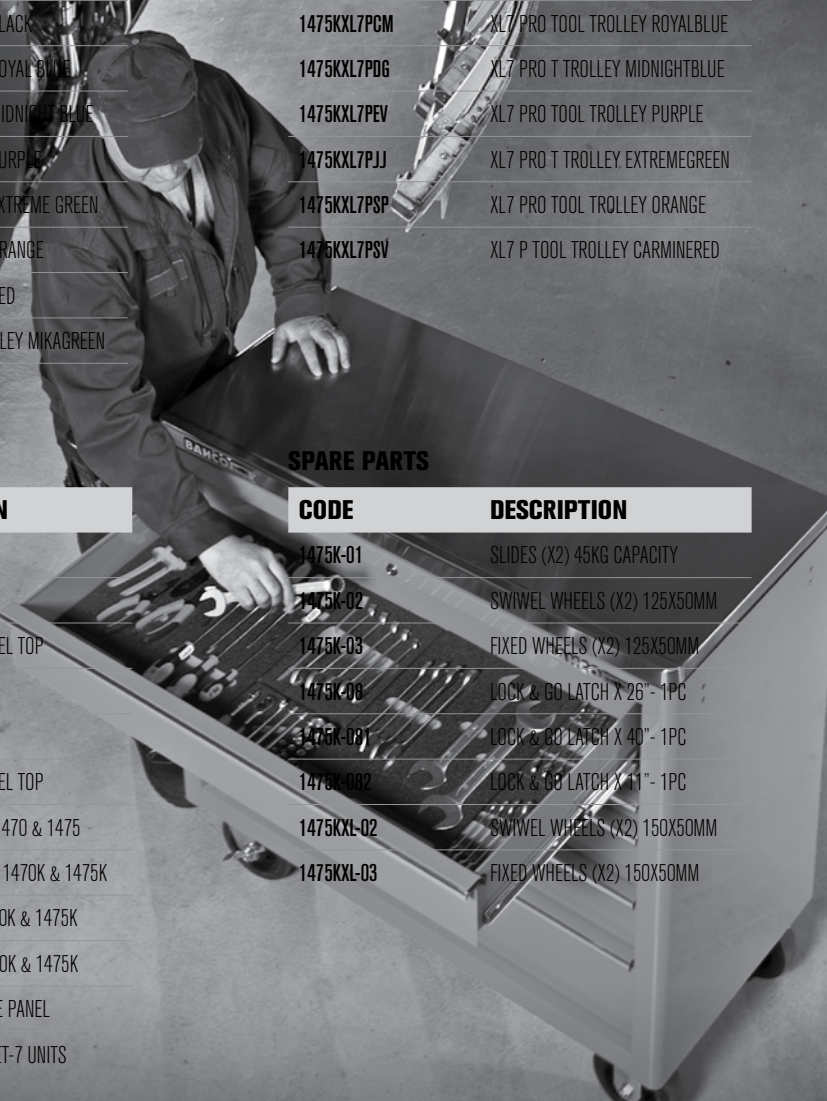



1470KC SERIES ROLL CARTS

- 3 drawers & 2 trays roll cart
- Large foldable tray included: 435 x 425 mm
- Pry bar / screwdriver key locked box included: 23 holes with divers diameters
- Manufactured and designed for easy and quick assembly
- Strong and secure round type key and locking mechanism with same combination in roll cart and pry bar / screwdrivers box
- Wheels of 100 x 25 mm with ball bearings and non-marking TPR out surface
- 2 swivel, 2 swivel with brake
- Large capacity drawers with click/detent system and 100% opening ball bearings
- Drawers can be lock from the upper tray
- Drawers internal dimensions:
 - (2x) 675 x 375 x 50 mm
 - (1x) 675 x 375 x 110 mm
- Upper tray with 2 gas springs lid that provides a large working surface of 700 x 440 mm
- Upper and bottom trays internal dimensions:
 - (2x) 755 x 425 x 75 mm
- 1470KC5: Orange
- 1470KC5PC: Black



Internal drawer locking



2 gas springs



Aluminium U shape two structures



Stable wheels with break



Click/detent system and 100% opening ball bearings



Large foldable tray



Round key locking system



Lockable tool holder

--	--	--	--	--	--	--

1470KC5	1315x440x1025	675x375x40	30	25x100	50	Orange
1470KC5PC	1315x440x1025	675x375x40	30	25x100	50	Black

1470KC SERIES ROLL CARTS

- 3 and 2 trays roll cart
- Large capacity trays for storing small and bulky objects
- Manufactured and designed for easy and quick assembly
- Aluminum U shape two structures
- Wheels of 25 x 100 mm with ball bearings and non-marking TPR out surface
 - 2 swivel
 - 2 swivel with brake
- Trays nominal dimensions:
 - (3X) 750 x 425 x 77 mm

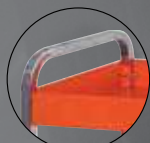

Aluminium U shape two structures



Stable wheels with brake

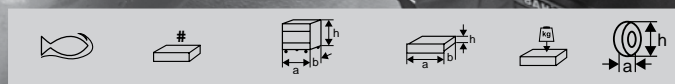

1470KC3	3	1315x440x1025	675x375x40	50	25x100
1470KC2	2	1315x440x1025	675x375x40	50	25x100
1470KCTRAY	1	757x428x77	757x425x77	50	

SPARE PARTS

CODE	DESCRIPTION
1470KC2-02	SWIWEL WHEELS W/ BRAKE (X2) 100X25MM
1470KC2-03	SWIWEL WHEELS (X2) 100X25MM
1470KC5-01	SLIDES (X2) 30KG CAPACITY





1483K SERIES METALLIC CASES

- Big capacity but compact case combining drawers for small tools and the upper tray for medium size ones
- The lid is reinforced externally with an aluminium plate and internally within a metallic grid that also stands the clips for hammers or the other long tools
- The lid handle and the lateral ones allow the case to be handled by two persons and make its transport easy and comfortable even when very loaded
- The case can be secured with standard locks thanks to the lid closing metallic latches that are having the O for them
- Double wall frame protects the slides and drawers from shocks/crashes
- Reinforced areas to reduce stress in specific points of the case
- Long ball bearing slides with 100% opening drawers
- Click/detent closing system of drawers
- Due to an internal system, the drawers are locked when the lid is closed
- Drawers internal dimensions:
 - (4x) 455x208x39 mm
- Upper tray internal dimensions:
 - (1x) 520x250x60 mm



100% opening drawers



Under lid grid for tool holding clips



Lid handle for transport in confined spaces



Aluminium plate reinforcement of lid



Strong lateral handles for easy transport



Drawer blocking system



1483K2RB



1483K3RB



1483KHD3RB



1483KHD4RB

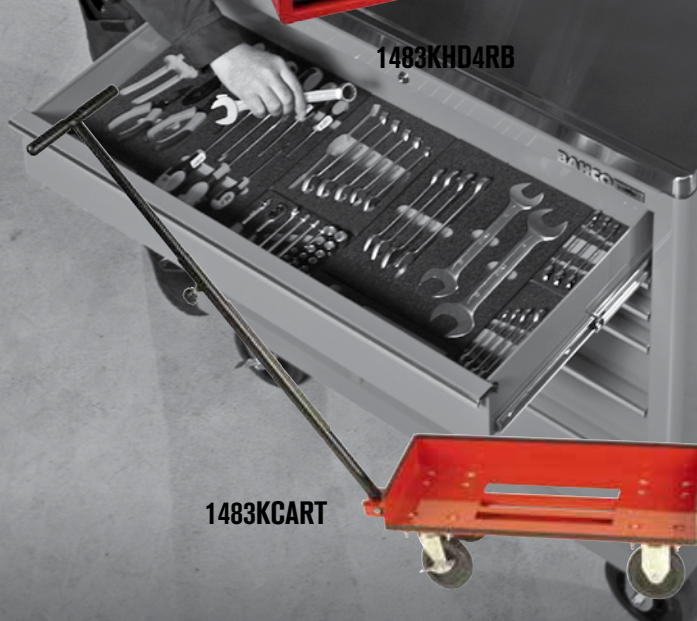





1483KCART

1483K SERIES METALLIC CASES



- Big capacity but compact case combining drawers for small tools and the upper tray for medium size ones
- The lid is reinforced externally with an aluminium plate and internally within a metallic grid that also stands the clips for hammers or the other long tools
- The lid handle and the lateral ones allow the case to be handled by two persons and make its transport easy and comfortable even when very loaded
- The case can be secured with standard locks thanks to the lid closing metallic latches that are having the O for them
- Double wall frame protects the slides and drawers from shocks/crashes
- Reinforced areas to reduce stress in specific points of the case
- Long ball bearing slides with 100% opening drawers
- Click/detent closing system of drawers
- Due to an internal system, the drawers are locked when the lid is closed
- Drawers internal dimensions
 - (4x) 455x208x39 mm
- Upper tray internal dimensions:
 - (1x) 520x250x60 mm

	#	 mm			 kg
1483K2RB	2	523x257x247	455x208x39	520x250x60	9,00
1483K3RB	3	523x257x300	455x208x39	520x250x60	10,00
1483KHD3RB	3	523x257x300	455x208x39	520x250x60	11,00
1483KHD4RB	4	523x257x353	455x208x39	520x250x60	12,00

SPARE PARTS

CODE	DESCRIPTION
1483K2-01	SLIDES (X2) KG CAPACITY
1483KHD3-15	FOLDABLE HANDLES (X2)
1483KHD3-20	LID HOOK SET



4750RCHD SERIES

INDESTRUCTIBLE TOOL CASE WITH INJECTED COPOLYMER POLYPROPYLENE



- Reinforced angles and ribs for maximum protection
- Corrosion, water and dust proof - all parts are Skydrol resistant
- Extremely resistant to very low and high temperature: -33° to 90°
- Airtight PU injected O-ring seal
- Manual air pressure valve
- Stainless steel pins
- Integrated identification / name badge
- Padlockable
- Interstackable



Air pressure valve



Stackable



Lockable



Shoulder strap
4750RCHD01



Wheels
4750RCHDW01 &
4750RCHDW02



Handle and
identification badge



Telescopic handle
4750RCHDW01 &
4750RCHDW02



Latches



4750RCHDW02

4750RCHDW01

4750RCHD01

4750RCHD00

ACCESSORIES

Removable Lid Panel



4750RCHD01AC1
Accessory for 4750RCHD01

4750RCHDW01AC1
Accessory for 4750RCHDW01

Removable Padded Bag



4750RCHD01AC2
Accessory for 4750RCHD01

4750RCHDW01AC2
Accessory for 4750RCHDW01

TSA approved Lock



4750RCHD-AC1
Accessory for all
4750RCHD cases

4750RCHD SERIES

INDESTRUCTIBLE TOOL CASE WITH INJECTED COPOLYMER POLYPROPYLENE

- Reinforced angles and ribs for maximum protection
- Corrosion, water and dust proof - all parts are Skydrol resistant
- Extremely resistant to very low and high temperature: -33° to 90°
- Airtight PU injected O-ring seal
- Manual air pressure valve
- Stainless steel hinges
- Integrated identification / name badge
- Padlockable
- Interstackable



ACCESSORIES

CODE	DESCRIPTION
4750RCHD01AC1	LID PANEL X 4750RCHD01
4750RCHD01AC2	INTERNAL BAG X 4750RCHD01
4750RCHDW01AC1	LID PANEL X 4750RCHDW01
4750RCHDW01AC2	INTERNAL BAG X 4750RCHDW01
4750RCHD-AC1	TSA LOCK X 4750RCHD01/011

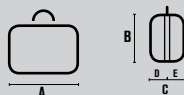

4750RCHD00



	Int. / Ext.
A	380 / 410
B	270 / 340
C	180 / 205
D	45
E	135



3,15

18,5

4750RCHD01



4750RCHD011
tool pallet included

	Int. / Ext.
A	445 / 474
B	345 / 415
C	190 / 214
D	47
E	143

4750RCHD01



4

29,2

4750RCHDW01



	Int. / Ext.
A	517 / 548
B	277 / 297
C	217 / 247
D	50
E	167

4750RCHD011



6,5

29,2

4750RCHDW02



	Int. / Ext.
A	538 / 627
B	405 / 475
C	250 / 292
D	60
E	190



10

53,01

4750RCWD4

RIGID CASE ON WHEELS



- Case made of Copolymer Polypropylene (PP) compound/ resin, provides an excellent capacity to impacts and performance even under extreme conditions
- The whole case can be locked by using a padlock. Central one is metal reinforced but there are various others for completely securing the case. Use the BAHCO padlock 4750RCHD-AC1
- Top compartment is the biggest storage area of the case and it is covered by a lid that it is secured by 2 latches. Can be under locked using the key
- Top compartment is the biggest storage area of the case and it is covered by a lid that it is secured by 2 latches. Can be under locked using the key
- Bottom compartment is protected by a door which is secured by 2 latches. Can be folded 165° making its opening easy when it is on a table
- Central key lock, secures top and bottom compartments. 200 different lock combinations
- Embossed BAHCO logo on the bottom compartment front cover for brand building. Can be opened 165° down and remove if necessary

CODE	DESCRIPTION
4750RCWD4	CASE ON WHEELS 4 DR
4750RCWD	CASE W/O DRAWERS
4750RCWDD1	30MM DR X 4750RCWD- 1 SLOT
4750RCWDD2	60MM DR X 4750RCWD- 2 SLOTS
4750RCWDD3	95MM DR X 4750RCWD- 3 SLOTS
4750RCWDD4	PORTABLE TRAY
4750RCWD-AC1	4 PIVOT WHEELS X 4750RCWD
4750RCWD-AC2	LID PALLET W/ POUCHES
4750RCWD-AC3	LID PALLET W/ ELASTICS
4750RCWD-AC4	LID PERFO. PALLET W/ ELASTICS & CLIPS
4750RCHD-AC1	TSA LOCK X 4750RCHD CASES

SPARE PARTS

CODE	DESCRIPTION
4750RCWD4-01	TELESCOPIC HANDLE
4750RCWD4-02	FEET (X2)
4750RCWD4-03	PAIR OF TWIN WHEELS
4750RCWD4-04	CENTRAL LOCK W/ 2 KEYS
4750RCWD4-07	LATCH X 1





4750RCWD4 RIGID CASE ON WHEELS

- The case includes a portable tray which is very practical for taking just the needed tools and bringing them to the needed place
 - Specific protected space for case identification
 - 8 drawer slots: the case is provided following the configuration you can see but the drawers' position can be easily change due to case's 8 slots. There are no sliders and drawers work by friction having latches that avoid the drawers to fall out accidentally
 - Top compartment is the biggest storage area of the case and it is covered by a lid that it is secured by 2 latches. Can be under locked using the key
 - Lateral big handles on the sides: are very practical for when lifting the case as well as for when pulling it when it is stored within a corner, van, etc.
 - Drawer handles: pivoting system and very flat for space reasons, make the opening of the drawers easy even when wearing gloves
- Under lid optional pallets: the User can separately personalized its case by getting different under lid pallets options we offer. They are easy to assembly and cover different needs

Pivoting under lid pallet options:



4750RCWD-AC2
Pouch system

4750RCWD-AC3
Fixed elastics

Under lid Fixed pallet option:
4750RCWD-AC4 Adjustable elastics

Swiveling wheels kit accessory: 4750RCWD-AC1

- By removing the front feet, 4 swiveling wheels can be assembly
- making its driving even easier when working in flat floors
- Increases the height in 45mm.
- For safety, 2 of them include brake.
- Dim: 50x18mm
- Hub: Polyamide
- Tyre: Polyurethane



4750RC SERIES RIGID TOOL CASES



- 2 metal locks with keys
- 2 metal lid safety support stays
- 1 pallet positioning rubber strip
- 3 metal hinges for maximum strenght
- Rubber coated heavy duty handle
- Document area
- Bottom area with removable dividers
- Identification label in one of the case side
- 1 lid tool pallet:
 - 4750RC02: With elastic pouches
 - 4750RC021: With rubber strips on two sides
- 1 bottom tool pallet:
 - 4750RC02: With transparent pouches on one side
 - 4750RC021: With rubber strips on one side



**4750RC02
and 4750RCW01**
Plastic Pouches



**4750RC021
and 4750RCW011**
Rubber Strips



4750RCW01 / 4750RCW011

4750RC02 / 4750RC021



4750RC01

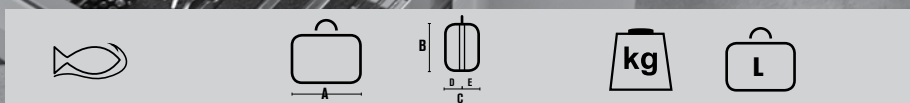

	A	B	C	D	E	kg	L
4750RC01	430	340	156	78	78	3	23
4750RC02	465	352	215	95	120	5	35
4750RC021	465	352	215	95	120	5	35
4750RCW01	465	352	215	95	120	5,5	42
4750RCW011	465	352	215	95	120	5,5	42

1495C SERIES CABINET WITH SHUTTER

- **Compact structure:** The depth of 170mm is good enough for storing tools but, at the same time, very compact
- **Dimensions:** 1.500 x 170 x 900 mm / 1.800 x 170 x 900 mm
- **Accessories:** A comprehensive kit of hooks is available for making the decision easy to the User. 1495CS-AC1 includes 35 different hooks which is a good base for the majority of the users
- **Rolling system:** The shutter is rolled in the top side of the frame and can be easily rolled down using the 2 handles available



CODE	DESCRIPTION
1495CS15	cabinet w/ shutter 1500 mm
1495CS18	cabinet w/ shutter 1800 mm
1495CS-AC1	Hook set- 35P

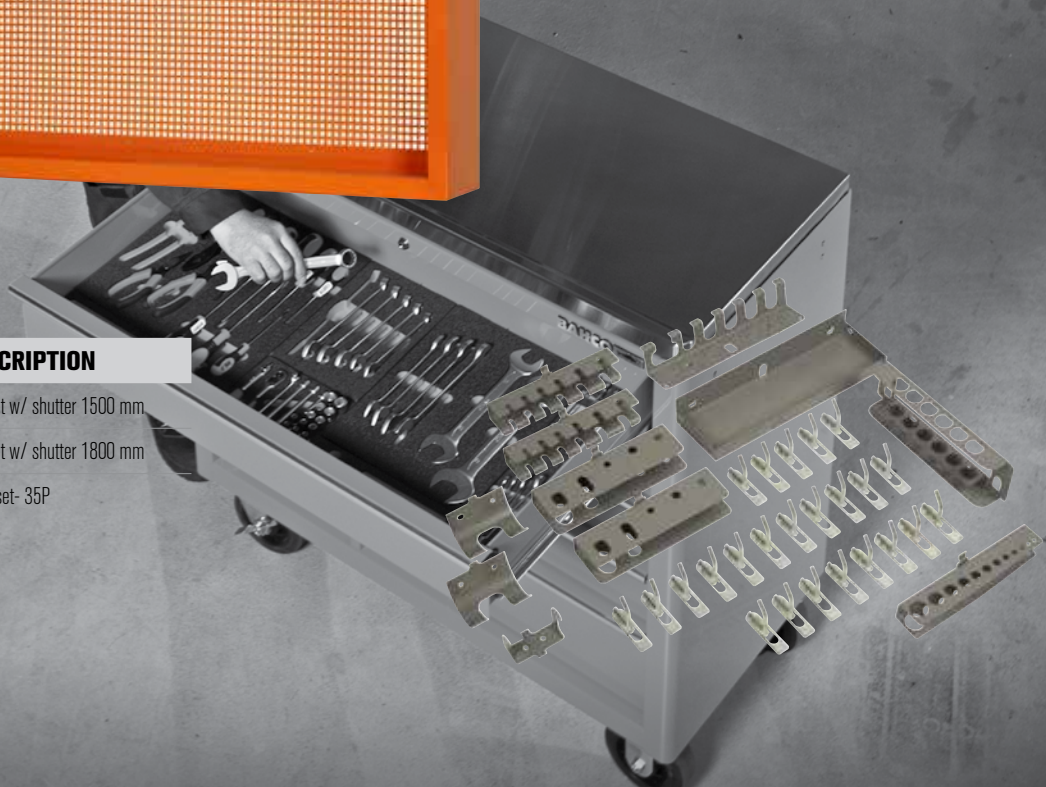

1495TP SERIES TOOL PANEL



- **Sturdy frame:**
The panel is having a frame which is bended in the edges in order to be able to stand to be mounted in walls (comes with hardware for that) and stands big loads without having any deformation
- **Four dimensions available:**
 - 600x25x500 mm
 - 1.200x25x800 mm
 - 1.500x25x800 mm
 - 1.800x25x800 mm
- **Accessories:** 1495GS-AC1 includes 35 different hooks which is a good base for the majority of the Users
- 1495TP-AC1 accessory is used for attaching the tool panels to workbenches with wooden or MDF tops

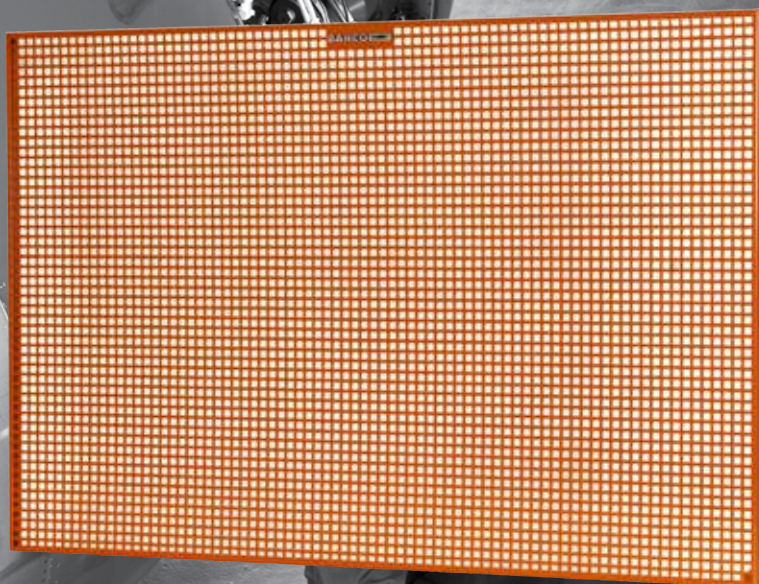

CODE	DESCRIPTION
1495TP06	Tool panel 600x25x500 mm
1495TP12	Tool panel 1200x25x800 mm
1495TP15	Tool panel 1500x25x800 mm
1495TP18	Tool panel 1800x25x800 mm
1495TP-AC1	Tool panel/ Workbench assembly adaptors

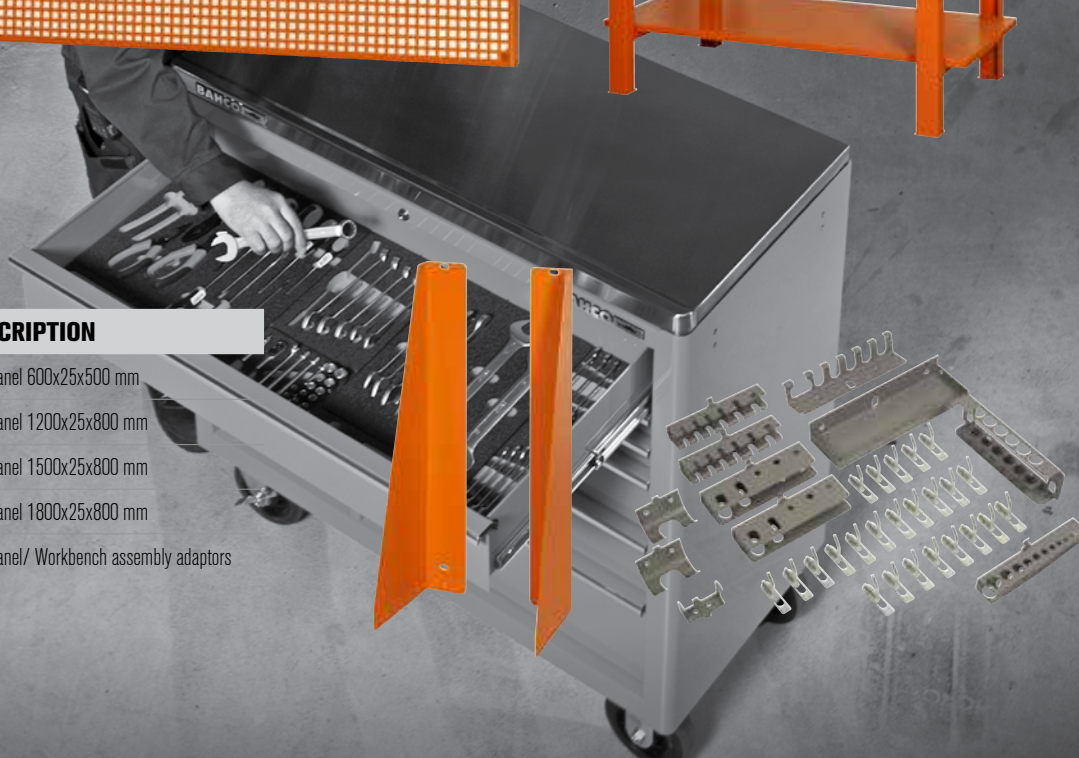



1495K SERIES WORKBENCHES

- Load capacity: 1,5T: Spread along the working surface
- Dimensions: the 2 options available are for professional use providing big working surfaces
 - 1.500 x 750 x 1.030 mm
 - 1.800 x 750 x 1.030 mm
- Feet:
 - U shape or provides robustness
 - The H shape welded feet
 - Brings strength and robustness
 - Flat shape end
 - Vulcanized rubber
 - Holes
- Free space can be used for storing 1470/75K BAHCO trolleys
- Chestnut or MDF top options: 40mm thickness
- Drawer tower based on the trolley assortment we have: 5, 6, 7 and 8 drawers within orange, blue, red or black colors
- Trolley adaptor for lifting the trolley to the necessary height. Provides big stability



		1500 MM				1800 MM			
		Orange	Red	Black	Blue	Orange	Red	Black	Blue
MDF	5	1495K5WB15TD	1495K6REDWB15TD	1495K8BKWB15TD	1495K6BLWB15TD	1495K6WB18TD	1495K6REDWB18TD	1495K8BKWB18TD	1495K6BLWB18TD
	6	1495K6WB15TD	1495K6REDWB15TD	1495K8BKWB15TD	1495K6BLWB15TD	1495K6WB18TD	1495K6REDWB18TD	1495K8BKWB18TD	1495K6BLWB18TD
	7	1495K7WB15TD	1495K7REDWB15TD	1495K7BKWB15TD	1495K7BLWB15TD	1495K7WB18TD	1495K7REDWB18TD	1495K7BKWB18TD	1495K7BLWB18TD
	8	1495K8WB15TD	1495K8REDWB15TD	1495K8BKWB15TD	1495K8BLWB15TD	1495K8WB18TD	1495K8REDWB18TD	1495K8BKWB18TD	1495K8BLWB18TD
WOODEN	5	1495K5WB15TW	1495K6REDWB15TW	1495K8BKWB15TW	1495K6BLWB15TW	1495K6WB18TW	1495K6REDWB18TW	1495K8BKWB18TW	1495K6BLWB18TW
	6	1495K6WB15TW	1495K6REDWB15TW	1495K8BKWB15TW	1495K6BLWB15TW	1495K6WB18TW	1495K6REDWB18TW	1495K8BKWB18TW	1495K6BLWB18TW
	7	1495K7WB15TW	1495K7REDWB15TW	1495K7BKWB15TW	1495K7BLWB15TW	1495K7WB18TW	1495K7REDWB18TW	1495K7BKWB18TW	1495K7BLWB18TW
	8	1495K8WB15TW	1495K8REDWB15TW	1495K8BKWB15TW	1495K8BLWB15TW	1495K8WB18TW	1495K8REDWB18TW	1495K8BKWB18TW	1495K8BLWB18TW

1495WB SERIES WORKBENCH



- Load capacity: 1,5T: spread along the working surface
- Feet:
 - U shape of provides robustness
 - The H shape welded feet brings strength and robustness
 - Flat shape end
 - Vulcanized rubber
 - Holes
- Dimensions: 2 options available are for professional use providing big working surfaces.
 - 1.500 x 750 x 1.030 mm
 - 1.800 x 750 x 1.030 mm
- 3 different top options available:
 - **Chestnut/ wooden top:** with 40mm thickness and varnished finished for long lasting, it is the best solution because absorbs very well impacts, lubricants, etc.
 - **MDF top:** with 40mm thickness, it is very consistent in strength and size and with similar characteristics to the chestnut but at a more affordable cost
 - **Steel top:** with 2mm thickness, it is strategically bended for making it very strong and HD. It is the sturdiest solution and, at the same time, the most affordable one

1495WB15TS

1495WB15TD

1495WB15TW

1500 x 750 x 1030 mm

1495WB18TS

1495WB18TD

1495WB18TW

1800 x 750 x 1030 mm

1495WB-AC1

500 x 500 x 105 mm

1495WB-AC2

570 x 528 x 160 mm

1495WB15-AC1

1500 x 504 x 30 mm

1495WB18-AC1

1800 x 504 x 30 mm

- Includes metallic dividers
- Can be assembled in any of the sizes
- Removable tray

1495FWB SERIES FOLDABLE WORKBENCH



- Compact structure: Scissor system: compact bridges provide strength and stability
- Plastic caps in structure's feet: Provide stability and avoids any slippery situation regardless the surface we are working on
- Plastic caps in structure top sides:
- Make the top mounting easy and tight for avoiding any movement while working
- MDF combined with galvanized top
 - Galvanized top
- Two dimensions available:
 - 970 x 500 x 840 mm
 - 1.200 x 500 x 840 mm
- Load capacity: 300 kg, spread along the working surface
- Rubber handles: Large enough and protected with rubber for avoiding injuring the user



CODE	DESCRIPTION
1495FWB097TS	Foldable workbench Galvanized Top 970 x 500 x 840 mm
1495FWB120TS	Foldable workbench Galvanized Top 1200 x 500 x 840 mm
1495FWB097TD	Foldable workbench MDF + Galvanized Top 970 x 500 x 840 mm
1495FWB120TD	Foldable workbench MDF + Galvanized Top 1200 x 500 x 840 mm

1495TP SERIES TOOL PANEL ON WHEELS

- Spacious bottom compartment for storing bulky tools, products, tanks or similar
- Load capacity: 300 kg. Spread along the working surface
- Wheels with brake (2) for avoiding any unexpected movement
 - Dim: 100 x 25 mm
 - Material: anti marking rubber
- Handles in both sides for easy moving the trolley and providing more safety
- Accessories: 1495CS-AD1 includes 35 different hooks which is a good base for the majority of the users



- Tray on top: used for storing any screw, nut, etc. the user has disassembled

CODE	DESCRIPTION
1495TP10W	Tool panel on wheels 1000 x 450 x 1500mm

1495CD SERIES CABINET WITH 2 DOORS ON WHEELS

- Compact structure: 1mm & 2mm sheet metal
The steel frame makes it very robust and capable to load it heavily
- Dimensions: 605 x 250 x 900 mm
- Locking system: The cabinet can be easily closed and even secured with a key
- Built in hooks inside doors: the doors are opened 180° for full access
- Perforated panel on sides
- Built in drawer provides a closed space where the User can store any specific tools/ thing.
- 100% opening slides provide full access



HOOKS AND ACCESSORIES ASSORTMENT

CODE	DESCRIPTION
1495CD60	Tool cabinet w / 2 doors
1495CD60W	Tool cabinet w/ 2 door & on wheels
1495CD-AC1	Hook set- 24P

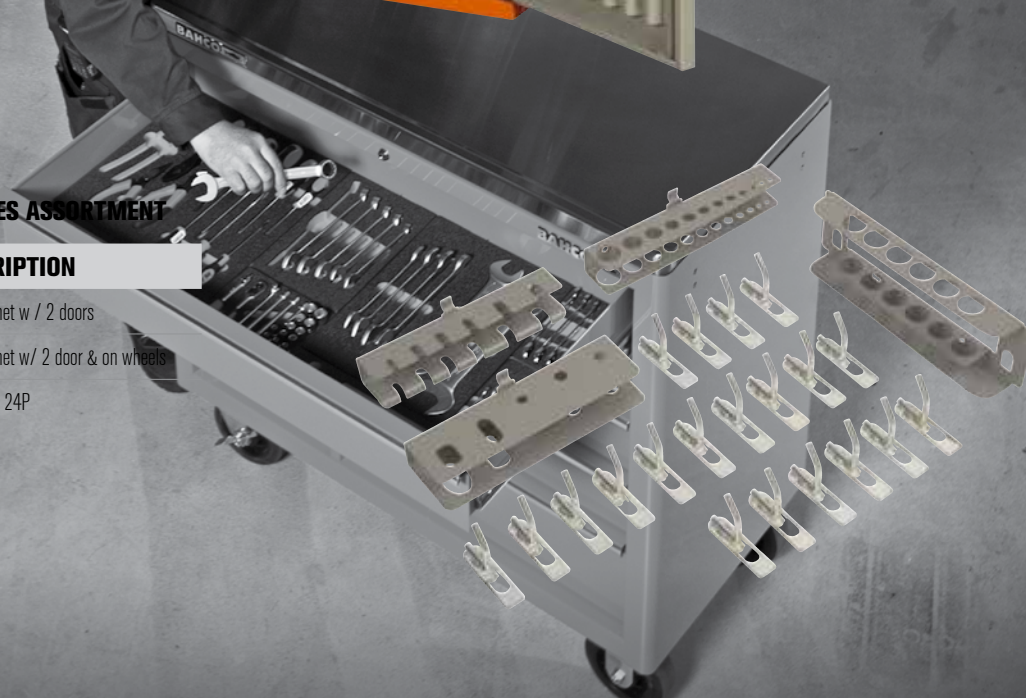

1495TP SERIES TOOL PANEL ON WHEELS

- Spacious bottom compartment for storing bulky tools, products, tanks or similar
- Load capacity: 300 kg. Spread along the working surface
- Wheels with brake (2) for avoiding any unexpected movement
 - Dim: 100 x 25 mm
 - Material: anti marking rubber
- Handles in both sides for easy moving the trolley and providing more safety
- Accessories: 1495GS-AD1 includes 35 different hooks which is a good base for the majority of the users

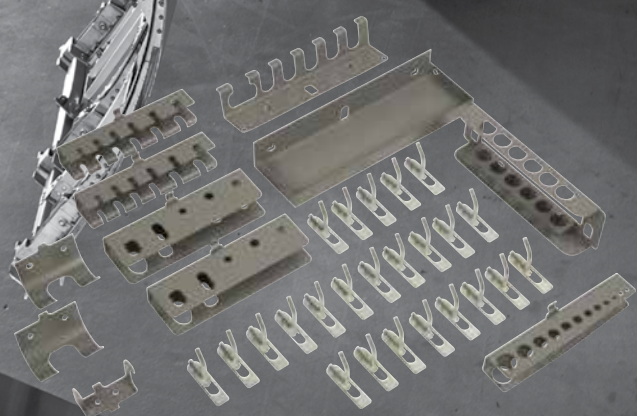

HOOKS AND ACCESSORIES ASSORTMENT

CODE	DESCRIPTION	CODE	DESCRIPTION
1495TP-ACHL20	HOOK 20MM L- 1 SLOT	1495TP-AC5	SCREWDRIVERS HOOK- 6 SLOTS
1495TP-ACHL40	HOOK 40MM L- 1 SLOT	1495TP-AC6	PLIERS HOOK- 5 SLOTS
1495TP-ACHL65	HOOK 65MM L- 1 SLOT	1495TP-AC7	GRIP HOOK- 1 SLOT
1495TP-ACHL90	HOOK 90MM L- 1 SLOT	1495TP-AC8	ALLEN KEYS HOOK- 12 SLOTS
1495TP-ACHU20	HOOK 20MM U- 1 SLOT	1495TP-AC9	DOUBLE SOCKET WR.HOOK-12 SLOTS
1495TP-ACHU40	HOOK 40MM U- 1 SLOT	1495TP-AC10	OPEN END WRENCH HOOK-12 SLOTS
1495TP-ACHU65	HOOK 65MM U- 1 SLOT	1495TP-AC11	PIN PUNCHES HOOK- 6 SLOTS
1495TP-ACHU90	HOOK 90MM U- 1 SLOT	1495TP-AC12	HAMMER HOLDER- 1 SLOT
1495TP-AC2	TRAY 1	1495TP-AC13	T HANDLE HOOK- 1 SLOT
1495TP-AC3	TRAY 2- FOR SOCKETRY		
1495TP-AC4	TRAY 3-PLASTIC		



4750FB1-19A NEW GENERATION OF SOFT BAGS

- 600 Denier polyester: used in areas with no risk of damaging the bag with a tip or any tool part. Provides flexibility and lightweight
- 1680 Denier polyester: used in areas with big risk of damaging the bag with a tip or sharp edge. Also in areas that need to be better protected against frictions or because they will stand big loads
- 100% Waterproof and anti slippery plastic hard bottom included in all the bags; provides big strength to the bag and protection against impacts thanks to the double stitching reinforcement HD PVC zips



Velcro straps for long tools:
Spirit levels, tubes and similar longer material can be stored using those straps with the quick velcro system positioned in both upper side of the bag

Soft grip handle:
Made of rubberized material. Provides a user friendly grip and isolates from touching any cold material

Measuring tape, card holder & phone pocket on one side

Hand saw special pocket:
With a zip and velcro strap for a quick storage, avoids any accident and / or lost during transport

HARD BOTTOM
100% waterproof

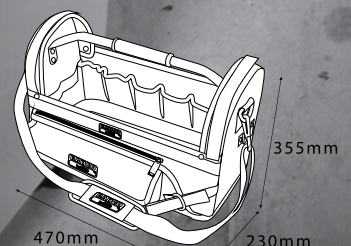



■ **4750FB1-19B**

NEW GENERATION OF SOFT BAGS

- 600 Denier polyester: used in areas with no risk of damaging the bag with a tip or any tool part. Provides flexibility and lightweight
- 1680 Denier polyester: used in areas with big risk of damaging the bag with a tip or sharp edge. Also in areas that need to be better protected against frictions or because they will stand big loads
- 100% Waterproof and anti slippery plastic hard bottom included in all the bags; provides big strength to the bag and protection against impacts thanks to the double stitching reinforcement
- HD PVC zips



Velcro straps for rolling the cover: keeps the bag open when necessary but, at the same time, the handsaw and other pockets can be still used

Screwdriver section: with elastics for keeping those tools always at hand

Soft grip handle made of rubberized material provides a user friendly grip and isolates from touching any cold material

Measuring tape, card holder & phone pocket on one side

Internal detachable tool panel with velcro system for quickly removing and bringing the needed tools. Elastics and pockets included

Hand Saw special pocket: with a zip and velcro strap for a quick storage, avoids any accident and / or lost during transport

HARD BOTTOM
100% waterproof

Softgrip handle access trough the cover

Velcro straps for long tools

Spirit level elastics
Holders on back side

Hard bottom: 100% waterproof

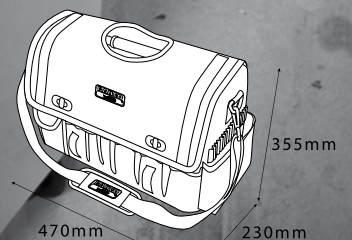



4750FB2W-24A NEW GENERATION OF SOFT BAGS

- 600 Denier polyester: used in areas with no risk of damaging the bag with a tip or any tool part. Provides flexibility and lightweight
- 1680 Denier polyester: used in areas with big risk of damaging the bag with a tip or sharp edge. Also in areas that need to be better protected against frictions or because they will stand big loads
- 100% Waterproof and anti slippery plastic hard bottom included in all the bags; provides big strength to the bag and protection against impacts thanks to the double stitching reinforcement
- HD PVC zips



Multiple screwdrivers
Internal pocket section

Handsaw internal
zipped pocket

Under lid not zipped
pocket for documents

10" Tablet
size specific pocket

Elastic & velcro quick
adjustable straps
for long tools such as
spirit levels, tubes . . .

Side horizontal handles: for
easier pulling the bag when stored
in confine places, pic ups, etc

Side big pouches:
Left one zipped detachable
Right fixed one includes
a plastic box for small
consumables: screws,
nuts, washers, terminals

HARD BOTTOM
100% waterproof



Telescopic handle:
960 mm max

Externally positioned pu
80 x 25 mm wheels:
For better stability and
Silent when rolling

Card holder

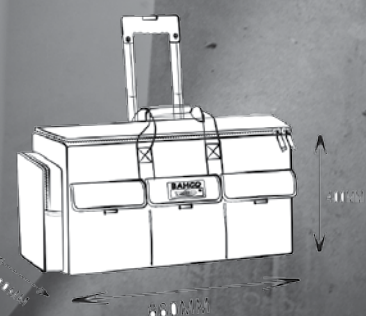



4750FB SERIES

NEW GENERATION OF SOFT BAGS

- 600 Denier polyester: used in areas with no risk of damaging the bag with a tip or any tool part. Provides flexibility and lightweight
- 1680 Denier polyester: used in areas with big risk of damaging the bag with a tip or sharp edge. Also in areas that need to be better protected against frictions or because they will stand big loads
- 100% Waterproof and anti slippery plastic hard bottom included in all the bags; provides big strength to the bag and protection against impacts thanks to the double stitching reinforcement
- HD PVC zips



HARD BOTTOM
100% waterproof

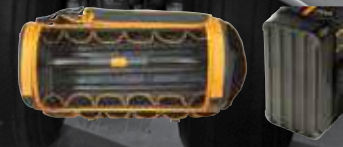

4750FB2-19A / 4750FB2-24A

Multiple internal and external pockets

Double heavy duty zips

4 practical pockets on one side

Handsaw internal holder (tip protector & handle velcro holder)

Quick adjustable straps for long tools such as spirit levels, tubes...

Measuring tape, card holder & phone pocket on one side

4750FB5A, 4750FB5B & 4750FB5C

- Measuring tape holder
- Rubber soft handle
- Multiple elastics for tool distribution in the bottom and upper side
- Card holder on front and labelling holder on the side for quick identification

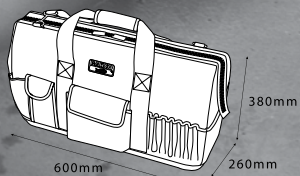

4750FB3-12

NEW GENERATION OF SOFT BAGS

- 600 Denier polyester: used in areas with no risk of damaging the bag with a tip or any tool part. Provides flexibility and lightweight
- 1680 Denier polyester: used in areas with big risk of damaging the bag with a tip or sharp edge. Also in areas that need to be better protected against frictions or because they will stand big loads
- 100% Waterproof and anti slippery plastic hard bottom included in all the bags; provides big strength to the bag and protection against impacts thanks to the double stitching reinforcement
- HD PVC zips



Multiple screwdrivers elastic section
In front and back side

Divers height pockets
replicated in both sides

HD reinforced handle
provides stability and strength the bag

Central big compartment
for bigger tools or material

Measuring tape, card holder & phone pocket on one side

Big bottom pocket
Including a plastic box for small consumables: screws, nuts, washers, terminals

HARD BOTTOM
100% waterproof



285mm
190mm
285mm

■ **4750FB4-18**

NEW GENERATION OF SOFT BAGS

- 600Denier polyester: used in areas with no risk of damaging the bag with a tip or any tool part. Provides flexibility and lightweight
- 1680Denier polyester: used in areas with big risk of damaging the bag with a tip or sharp edge. Also in areas that need to be better protected against frictions or because they will stand big loads
- 100% Waterproof and anti slippery plastic hard bottom included in all the bags; provides big strength to the bag and protection against impacts thanks to the double stitching reinforcement
- HD PVC zips



HARD BOTTOM
100% waterproof



Divers height pockets and sections in each compartment allows a better tool distribution and to bring only one to the work place for avoiding carrying a heavy bag

Central big padded compartment for laptop and similar delicate material and **two detachable side sections**



Side detachable compartment: each one has its own design for better covering the needs of each user



Measuring tape, card holder & phone pocket on one side

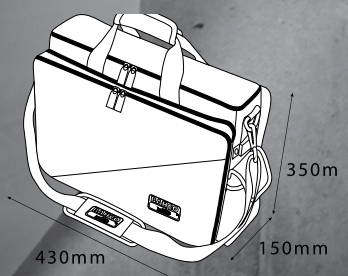

MASON BOX



- Internal protection using a 3.2 mm thick plywood with anti- humidity treatment
- HD constructions with weld points in key areas for making the box robust
- Combination of 0.8 mm and 1.0 mm thickness steel on the stressed areas for avoiding any deformation
- All boxes are including a tool tray which helps the User to carry the needed tools
- Orange powder coating with a texture finishing that is more resistant to the toughest working environments
- Lid opening system, with L- formed brackets on the back side, avoids any unexpected tilting of the box
- Document holder under the lid helps to keep papers and documents clean in the dirty environments those boxes are usually used
- All boxes are including a tool tray which helps the User to carry the needed tools w/o the need to move the big mason box



CODE	DESCRIPTION
1496MB2	530x290x290
1496MB3	690x360x310
1496MB4	830x440x340
1496MB5	910x530x530

■ **4750-EP-1**
ELECTRICIAN'S POUCH

- Universal tool loop for your bigger tools to keep them organized
- Chain hook for an easy access to insulation tapes or flex
- Main deep pocket for safe storage of long tools and fixings, etc.
- Additional pocket for smaller tools gives easy tool access
- Real leather slots on the sides ideal for holding longer tools i.e. screwdrivers, knives
- Necessary equipment always at hand when needed
- Made of strong 1680 Denier polyester



METRIC	
height	300 mm
length	270 mm
width	150 mm
weight	0.520 kg
volume	2.500 l



4750-DHO-3

DRILL HOLSTER RIGHT & LEFT HAND

- Holds any standard sized cordless or mains powered drill
- Suits left and right handed users as well as forward and backward facing machines
- Rubber slots on the top ideal for storing drill bits
- Genuine leather strap with a metal button holds the drill safely when climbing on or off scaffolding



METRIC	
height	290 mm
length	170 mm
width	170 mm
weight	0,260 kg
volume	0 l

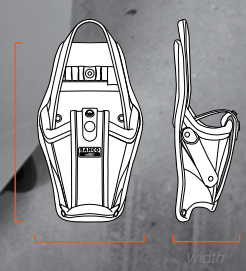

■ **4750-HHO-2**
HAMMER HOLDER



- Fits any BAHCO tool belt or normal clothing belt
- Useful while working with the hands up, when the quick access to tools is needed
- Made of strong 1680 denier polyester. Visible badge with BAHCO logo on the front of the holder. Swings to keep your hammer at a comfortable angle
- Solution with side gate lets you easily put the tool in without looking at the holder
- Keeps all kinds of common hammers used on building site



METRIC	
height	180 mm
length	120 mm
width	70 mm
weight	0,170 kg
volume	0 l

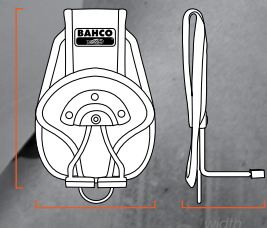

4750-MPH-1 MULTI PURPOSE HOLDER

- Riveted for truly unbreakable strength. Measuring tape clip for any common builder's tape measure from 3 to 10 meters long
- Made of strong 1680 denier polyester
- Extra leather slot in the middle for a pen or a small screwdriver
- Ideal item to be added to your own creation of Tool Belt Set together with other products
- Leather slots ideal for holding different types of tools i.e. knives, screwdrivers



METRIC	
height	240 mm
length	170 mm
width	60 mm
weight	0,220 kg
volume	0 l

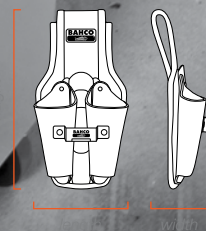

■ **4750-UP-1**
UNIVERSAL POUCH

- Fits any BAHCO tool belt or normal clothing belt
- Useful while working with the hands up, when the quick access to tools is needed
- Made of strong 1680 denier polyester. Visible badge with BAHCO logo on the front of the holder. Swings to keep your hammer at a comfortable angle
- Solution with side gate lets you easily put the tool in without looking at the holder
- Keeps all kinds of common hammers used on building site



METRIC	
height	260 mm
length	290 mm
width	180 mm
weight	0.550 kg
volume	2,000 l



4750-2PP-1 TWO POCKET FIXINGS POUCH

- Perfectly positioned wide pockets hold plenty of fixings and provide quick tool recognition. Fits any BAHCO tool belt or normal clothing belt
- Necessary equipment is at hand when needed. Made of strong 1680 denier polyester
- General shape with rigid pocket sides designed to keep the pouch
- Stable and vertical, preventing tools and fixings from falling out



METRIC	
height	260 mm
length	260 mm
width	180 mm
weight	0.370 kg
volume	2,000 l

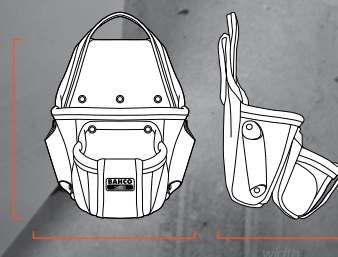

■ 4750-VMPH-1

VERTICAL SMARTPHONE HOLDER

- Closed by VELCRO for greater security
- Made of strong 1680 denier polyester
- Fits any belt from the Collection
- Works also without the belt
- Universal mobile phone holder with a flap for extra protection on a building site



METRIC	
height	160 mm
length	100 mm
width	35 mm
weight	0.080 kg
volume	0.120 l



4750-KNHO-0 / 4750-KNHO-1 KNIFE HOLDER

- Finished with an extra layer of suede leather to ensure resistance to years of wear and tear
- Necessary equipment is at hand when needed
- Riveted for truly unbreakable strength
- Made of strong 1680 denier polyester
- Fits any belt from the Collection
- Unique design of this holder specifically designed to suit the utility knives

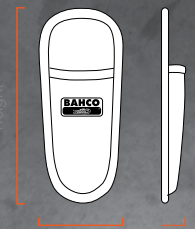
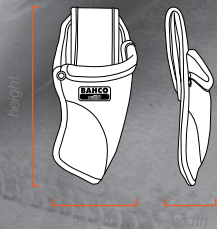

4750-KNHO-1

	METRIC
height	200 mm
length	100 mm
width	50 mm
weight	0,090 kg
volume	0,100 l

4750-KNHO-0

	METRIC
height	210 mm
length	85 mm
width	20 mm
weight	0,080 kg
volume	0,080 l

■ **4750-HDB-2**

HEAVY DUTY BELT WITH CUSHION

- Features a Heavy Duty Leather Belt with stainless steel twin-pin buckle
- Made of strong 1680 danier polyester with polyethylene backing
- Riveted for truly unbreakable strength



METRIC

height	190 mm
length	900 mm
width	50 mm
weight	0.650 kg
volume	0.250 l

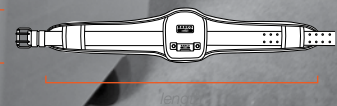



4750-QRFB-1
QUICK RELEASE FABRIC ADJUSTABLE BELT

4750-HDLB-1
HEAVY DUTY LEATHER BELT

- Simple design and flexibility of the belts helps in easy using
- Our belts are made of the high quality materials such as high grade leather or 1680 denier polyester
- Our belts are design in the universal sizes so they fit any weight



4750-QRFB-1

METRIC	
height	50 mm
length	1200 mm
width	0 mm
weight	0,310 kg
volume	0 l



4750-HDLB-1

METRIC	
height	50 mm
length	1290 mm
width	0 mm
weight	0,300 kg
volume	0 l

■ **4750-KP-1**
ANTI SLIP KNEE PADS

- Universal lightweight knee pads for different kinds of surfaces
- Heavy Duty rubber cups ensure comfort and safety when used in difficult conditions
- Elastic straps with hook-and-loop fasteners for easy adjustment to leg sizes
- Breathable 3D Air Mesh material lining provides maximum cushioning for all day of wearing
- Made from rubber and polyester 1680 denier ideal for most applications including general construction, use on uneven surfaces and for laying carpets, floor tiles and flooring etc.



	METRIC
height	160 mm
length	220 mm
width	70 mm
weight	0,300 kg
volume	0 l





4750PTB50 / 4750PTB60 PLASTIC TOOL BOXES

- Made of virgin polypropylene (PP) :
- Makes the box Heavy Duty even if used under extreme conditions
- Low and high temperatures resistance: -20C° / +50C°
- Load dynamic capacity: 20kg & 22kg
- Load static capacity: 120kg & 130kg
- Internal tray
- External box dividers
- Aluminum long handle
- Locking system
- Easy transportation
- Padlockable
- Metallic latches and galvanized key components:
 - Resistant to the rust and long lasting



4750PTB50



4750PTB60

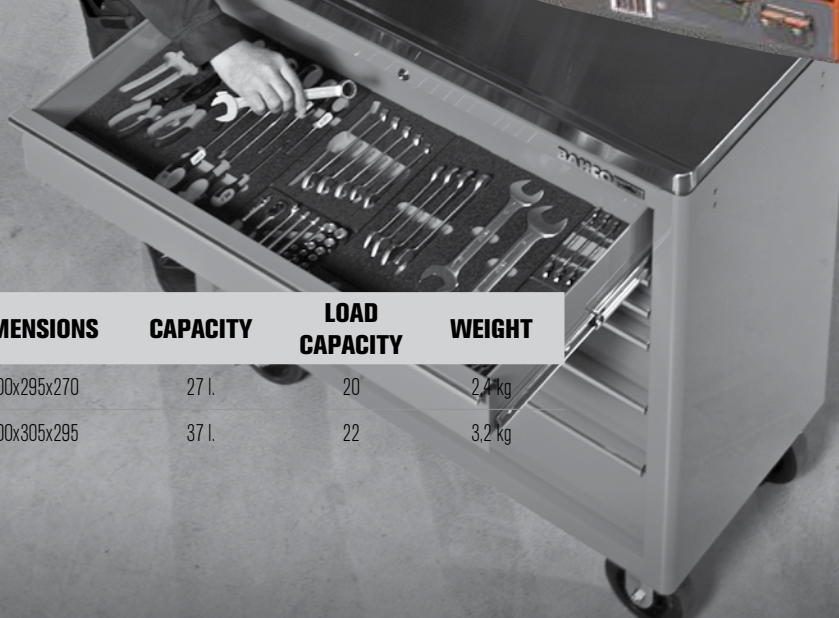

	DIMENSIONS	CAPACITY	LOAD CAPACITY	WEIGHT
4750PTB50	500x295x270	27l.	20	2,4 kg
4750PTB60	600x305x295	37l.	22	3,2 kg

■ **4750PTBW47**
PLASTIC TOOL BOXES



- Made of virgin polypropylene (PP):
 Makes the box Heavy Duty even if used under extreme conditions
 Low and high temperatures resistance: -20C°/ +50C°
 Load dynamic capacity: 25kg
 Load static capacity: this tower box is not intend to be used as a step
- External box diameter: 475mm
- Upper lid:
 • Internal tray
 • Padlockable
- Foldable handle: big grey color
- Metallic latches and galvanized key components
- Wheels: 135x37mm
 • Hub made in polypropylene plastic with a single galvanized axel
 • External wheel EVA material for a smooth and silent rolling

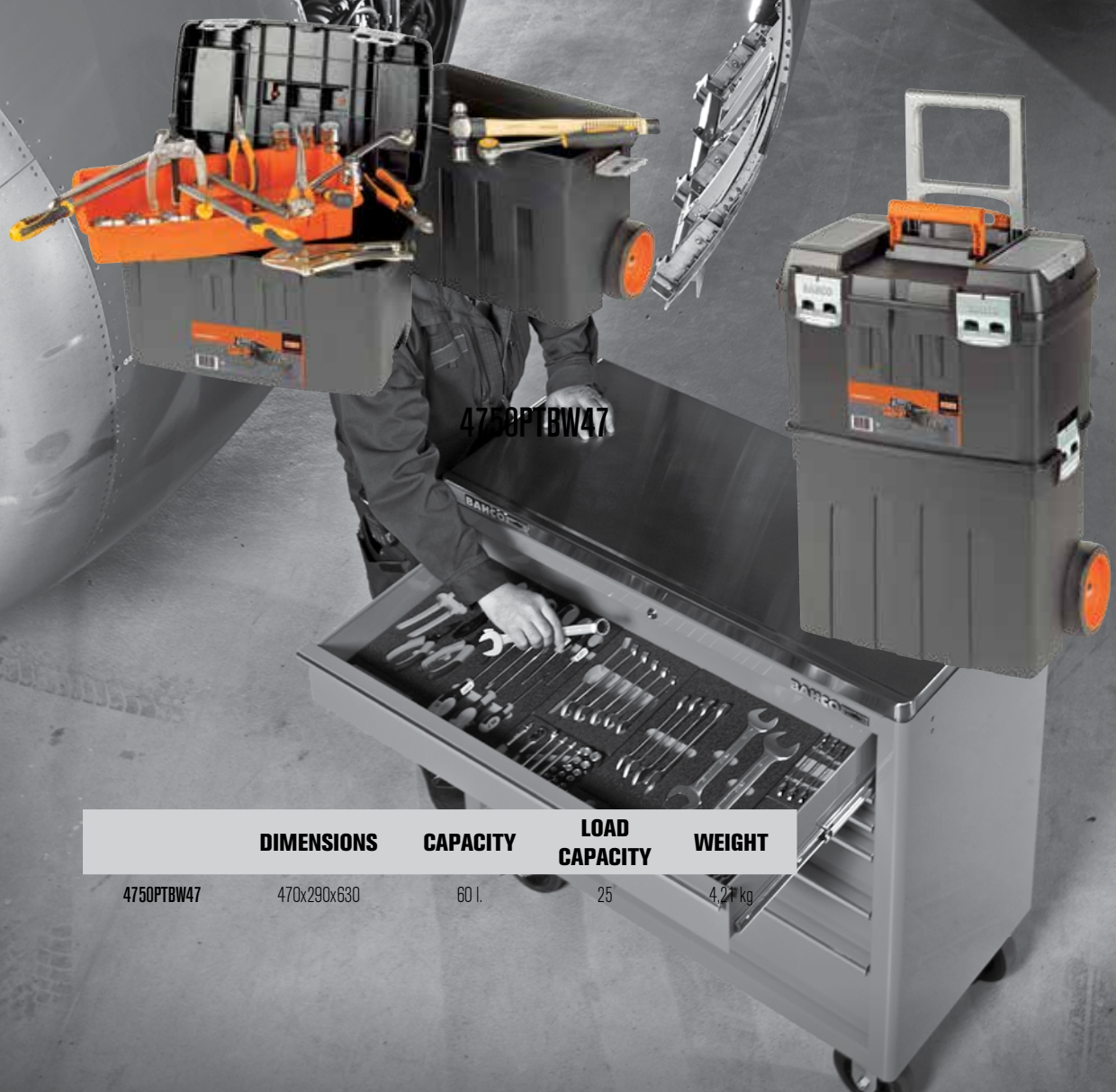

4750PTBW47

	DIMENSIONS	CAPACITY	LOAD CAPACITY	WEIGHT
4750PTBW47	470x290x630	60 l.	25	4,27 kg

По вопросам продаж и поддержки обращайтесь: bch@nt-rt.ru

www.bahco.nt-rt.ru

Архангельск (8182)63-90-72,
Астана+7(7172)727-132,
Белгород(4722)40-23-64,
Брянск(4832)59-03-52,
Владивосток(423)249-28-31,
Волгоград(844)278-03-48,
Вологда(8172)26-41-59,
Воронеж(473)204-51-73,
Екатеринбург(343)384-55-89,
Иваново(4932)77-34-06,
Ижевск(3412)26-03-58,
Казань(843)206-01-48,
Калининград(4012)72-03-81,
Калуга(4842)92-23-67,
Кемерово(3842)65-04-62,
Киров(8332)68-02-04,

Краснодар(861)203-40-90,
Красноярск(391)204-63-61,
Курск(4712)77-13-04,
Липецк(4742)52-20-81,
Магнитогорск(3519)55-03-13,
Москва(495)268-04-70,
Мурманск(8152)59-64-93,
НабережныеЧелны(8552)20-53-41,
НижнийНовгород(831)429-08-12,
Новокузнецк(3843)20-46-81,
Новосибирск(383)227-86-73,
Орел(4862)44-53-42,
Оренбург(3532)37-68-04,
Пенза(8412)22-31-16,
Пермь(342)205-81-47,
Ростов-на-Дону(863)308-18-15,

Рязань(4912)46-61-64,
Самара(846)206-03-16,
Санкт-Петербург(812)309-46-40,
Саратов(845)249-38-78,
Смоленск(4812)29-41-54,
Сочи(862)225-72-31,
Ставрополь(8652)20-65-13,
Тверь(4822)63-31-35,
Томск(3822)98-41-53,
Тула(4872)74-02-29,
Тюмень(3452)66-21-18,
Ульяновск(8422)24-23-59,
Уфа(347)229-48-12,
Челябинск(351)202-03-61,
Череповец(8202)49-02-64,
Ярославль(4852)69-52-93,